

1. Trade 1.0 ...  
2. ...  
3. ...  
4. ... Srvce ...  
5. ...  
6. ODM & OEM ... Pullman Loaf Pan.  
7. Tsingbuy Bread Loaf Pan ... Bakeware ... 12 ...

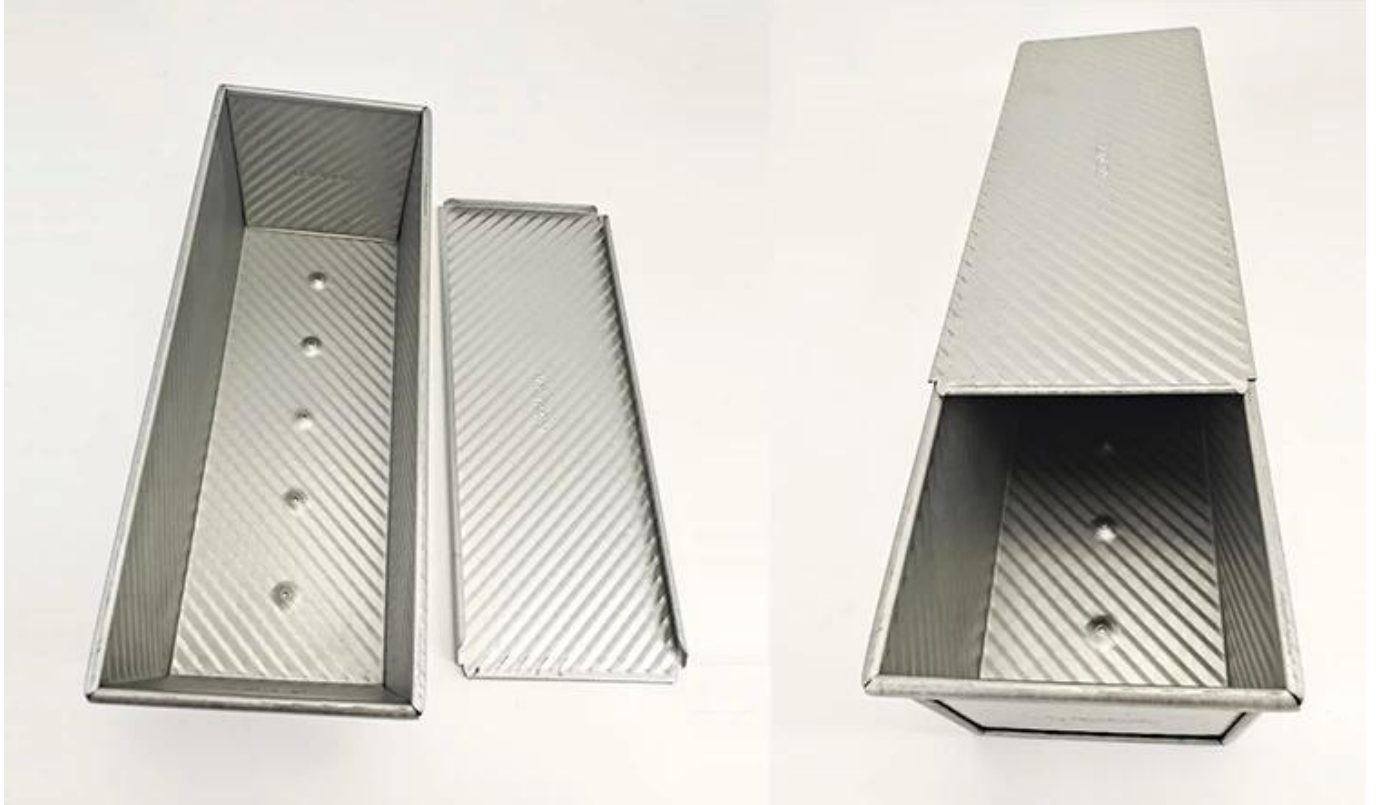

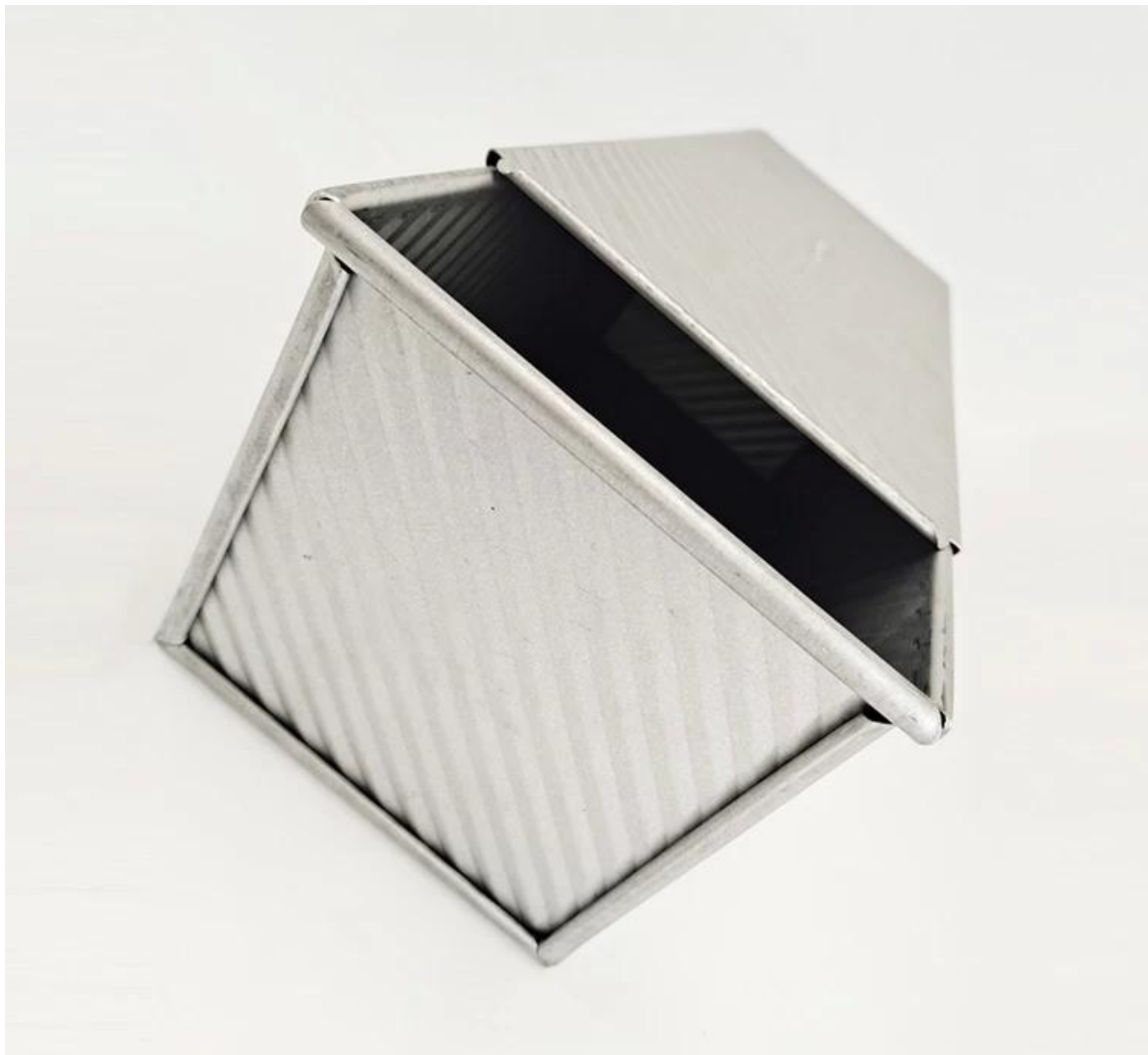







# customized single loaf pan





Teflon coating



Silicone coating



Material:

Aluminum alloy

Aluminized steel

Strap Loaf Pan 12 Bakeware

## More Customized Strap Loaf Pans from Tsingbuy





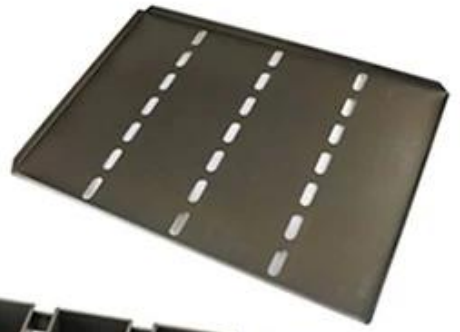



Customized shape  
Customized size  
Rack matched

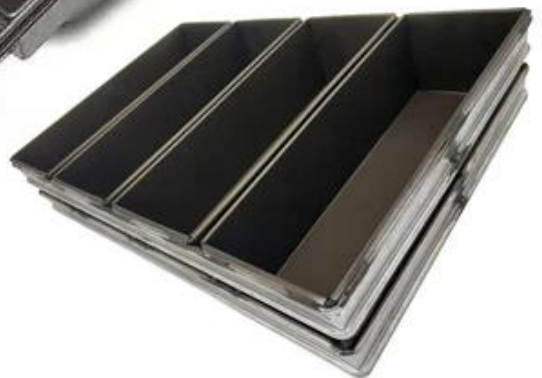

## Customized Single Loaf Pan

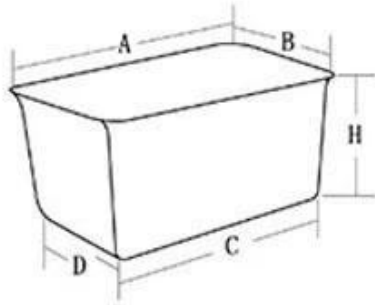

- A. Top length of the item
- B. Top width of the item
- C. Bottom length of the item
- D. Bottom width of the item
- H. Height

## Customized Strapped Loaf Pan Sets

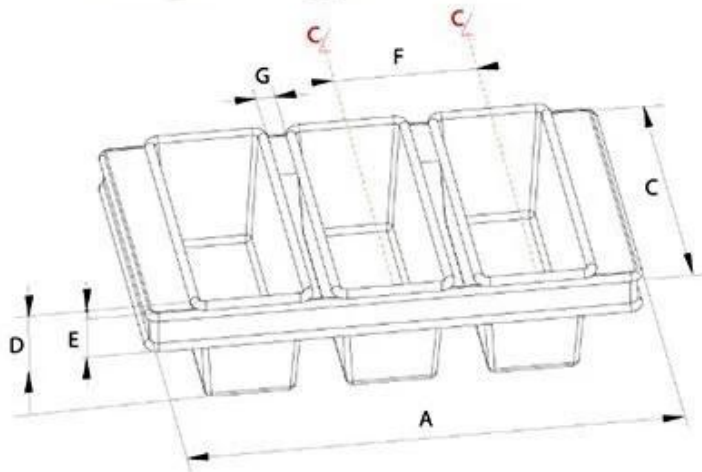

- A. Overall Length
- C. Overall Width
- D. Depth
- E. Frame Height
- F. Center-to-center
- G. Pan Distance



Flat handle



Frame handle



no handle



Matching lid (Drop Style)

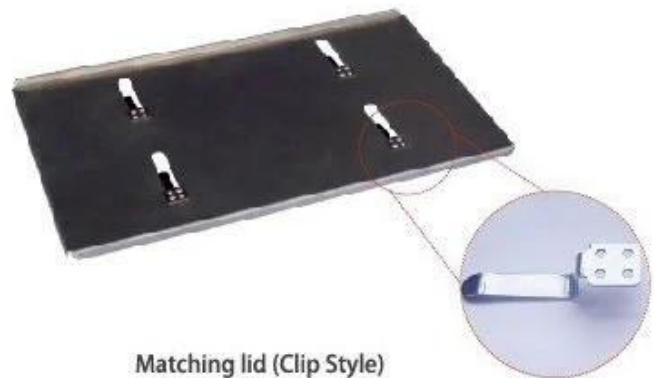

Matching lid (Clip Style)





# Loaf Pan

Tsingbuy Industry Limited



□□□□□□□□□□□□□□□□.