



**pullman bread loaf** □□□□□□□□□□□□□□□□□□□□ **ld**

# One Piece Integrated Molding Bread Loaf Pan with Lid



# Integrated Molding Aluminum Non Stick Bread Loaf Pan with Lid



## Holes at Bottom for Ventilation



ABLE AND EASY TO DEM

## Enjoy Your DIY with Family



Curled Edges for Four Sides  
Easy to Sliding-on-off cover

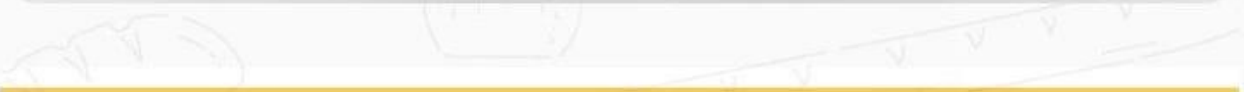



# Double-side Non Stick Coated Bread Loaf Pan with Lid







450g dough

baking pan weight: 309g

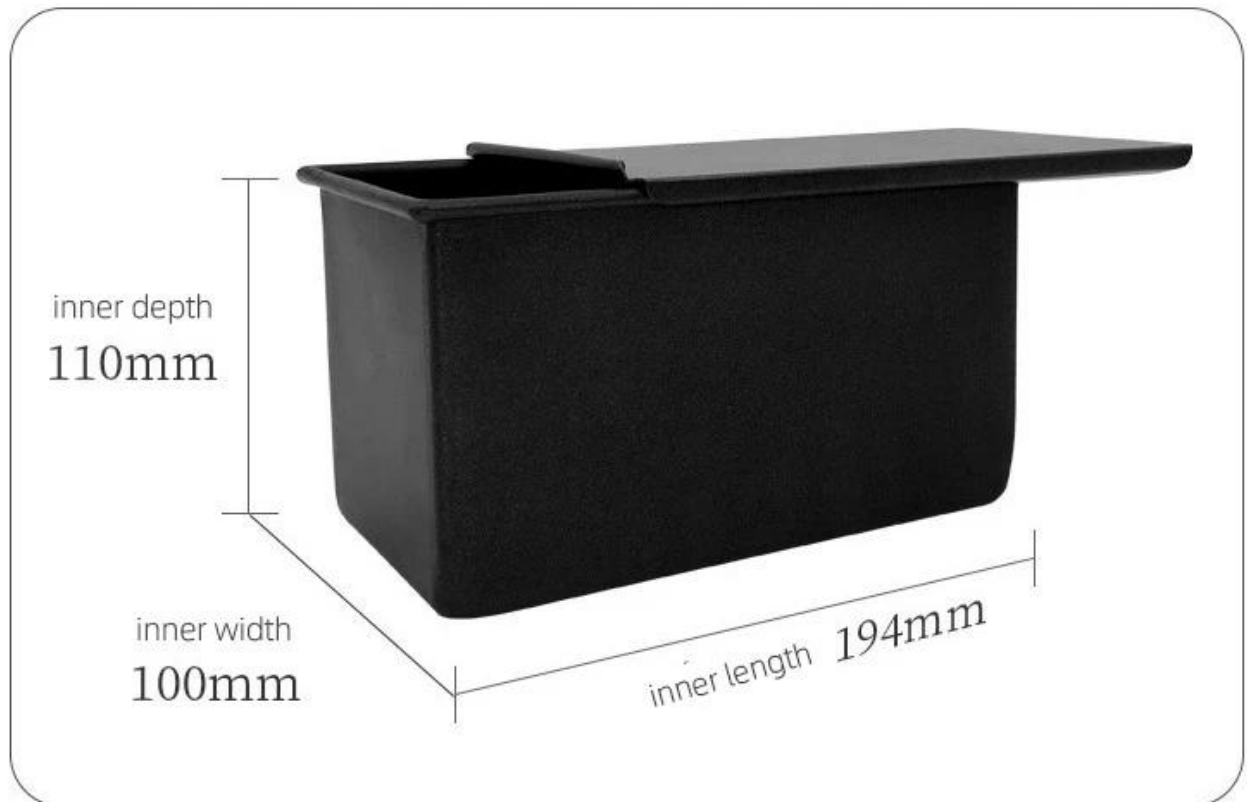



此類產品係由本公司自行研發，品質優良，價格公道，歡迎各界人士垂詢。

本公司地址：廣東省深圳市南山区蛇口街道九號路

電話：0755-88888888      傳真：0755-88888888  
郵箱：sales@company.com      網址：www.company.com  
地址：廣東省深圳市南山区蛇口街道九號路

產品名稱：黑色方形收納盒，尺寸：100mm x 100mm x 80mm

產品規格：黑色，表面有細微紋理，底部有防滑墊

產品用途：適用於存放文具、化妝品、小飾品等

產品特點：外觀簡約大方，實用耐用，易於清潔

產品包裝：每箱20個，內附說明書

產品價格：每只15元，每箱300元

# customized single loaf pan





Teflon coating

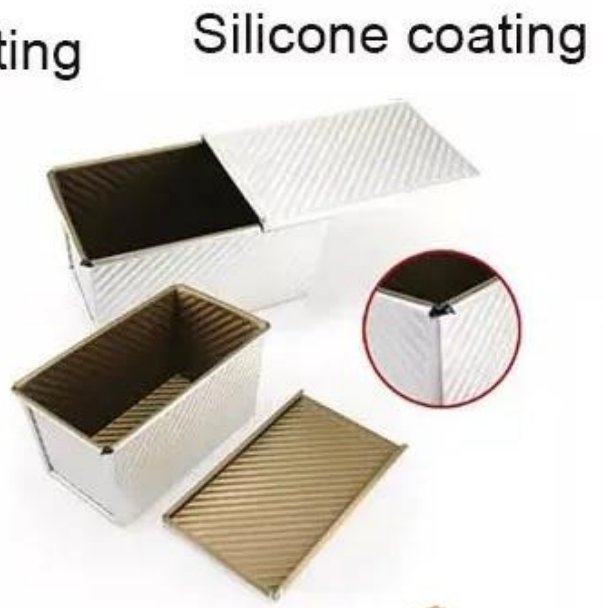

Silicone coating



Material:

Aluminum alloy

Aluminized steel



Our products are made of high quality materials and are designed for long service life. We offer ODM&OEM services and can customize products according to your requirements. Our products are widely used in various industries and are popular in many countries. We have a professional R&D team and a complete production system. We can provide you with the best quality products and the most competitive prices. We are committed to providing you with the best service and the most satisfactory results.

We are a professional manufacturer of various types of metal trays and pans. We have a rich experience in the industry and a complete production system. We can provide you with the best quality products and the most competitive prices. We are committed to providing you with the best service and the most satisfactory results. We have a professional R&D team and a complete production system. We can provide you with the best quality products and the most competitive prices. We are committed to providing you with the best service and the most satisfactory results.

## More Customized Strap Loaf Pans from Tsingbuy



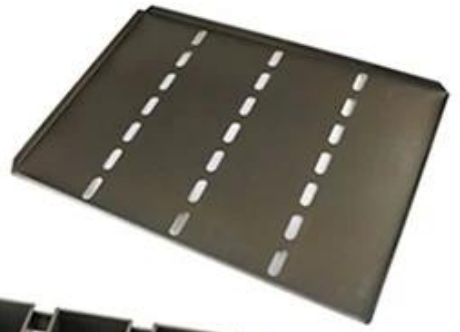



Customized shape  
Customized size  
Rack matched

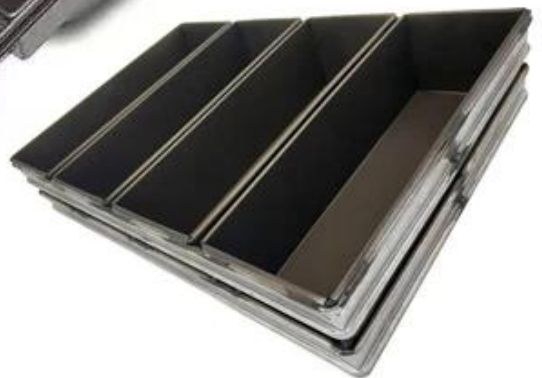

## Customized Single Loaf Pan

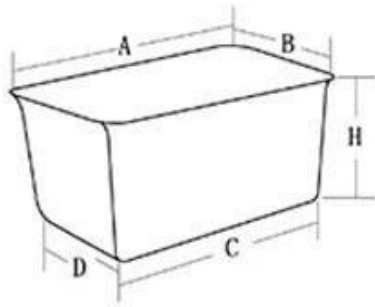

- A. Top length of the item
- B. Top width of the item
- C. Bottom length of the item
- D. Bottom width of the item
- H. Height

## Customized Strapped Loaf Pan Sets

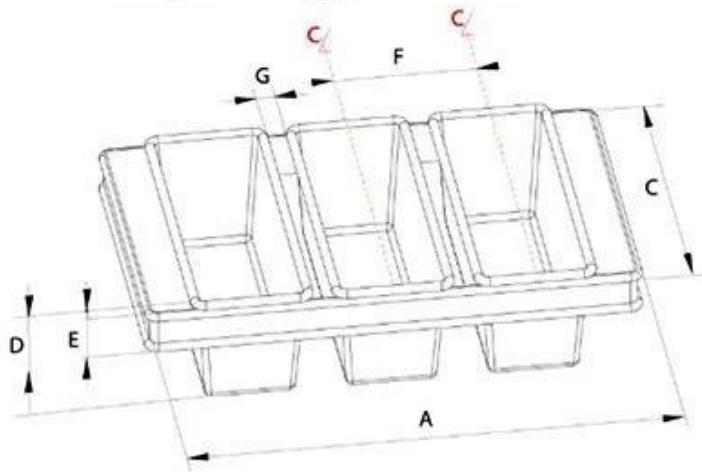

- A. Overall Length
- C. Overall Width
- D. Depth
- E. Frame Height
- F. Center-to-center
- G. Pan Distance



Flat handle



Frame handle



no handle

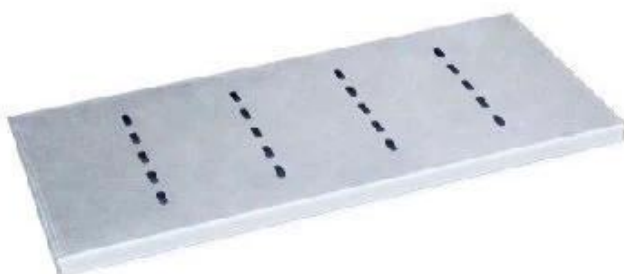

Matching lid (Drop Style)

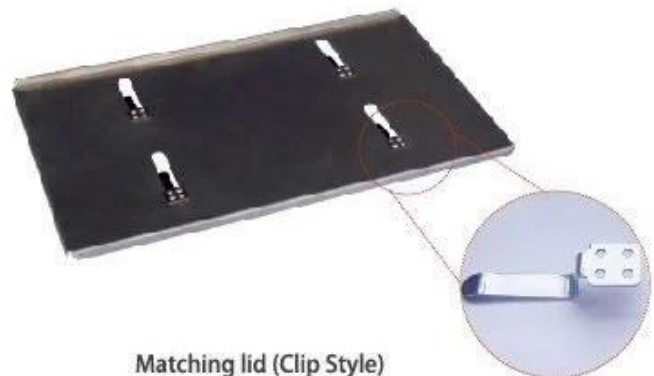

Matching lid (Clip Style)



XXXXXXXXXX

Tsingbuy 专业生产压铸铝、压铸锌合金、压铸铜合金、压铸镁合金、压铸钛合金、压铸不锈钢等合金铸件。我们拥有先进的压铸设备和精湛的工艺技术，产品广泛应用于汽车零部件、工业机械、五金工具、医疗设备、航空航天等领域。我们提供 ODM & OEM 服务，可根据客户需求定制各种规格的铸件。工厂占地面积大，设备先进，产能充足，交货迅速。欢迎广大客户垂询。



**Loaf Pan**

Tsingbuy Industry Limited



