

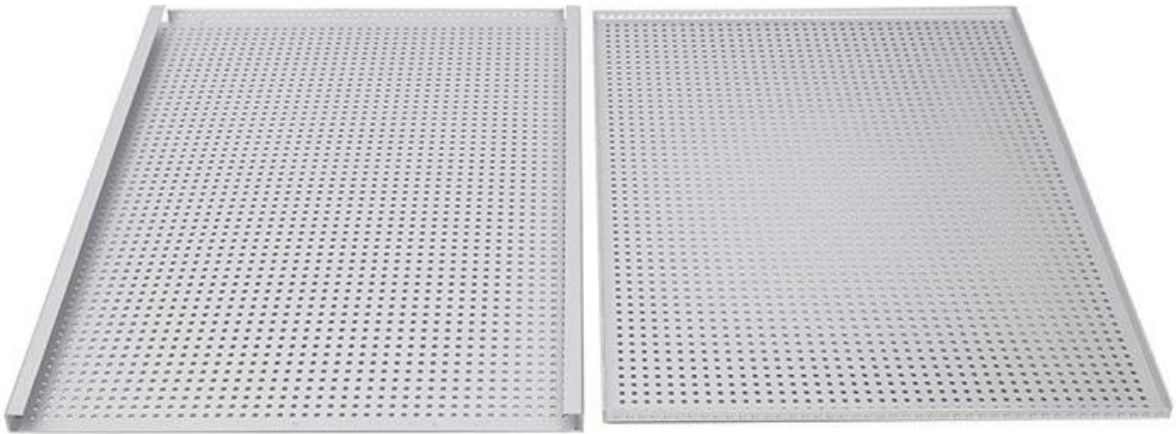

Multiple Functions

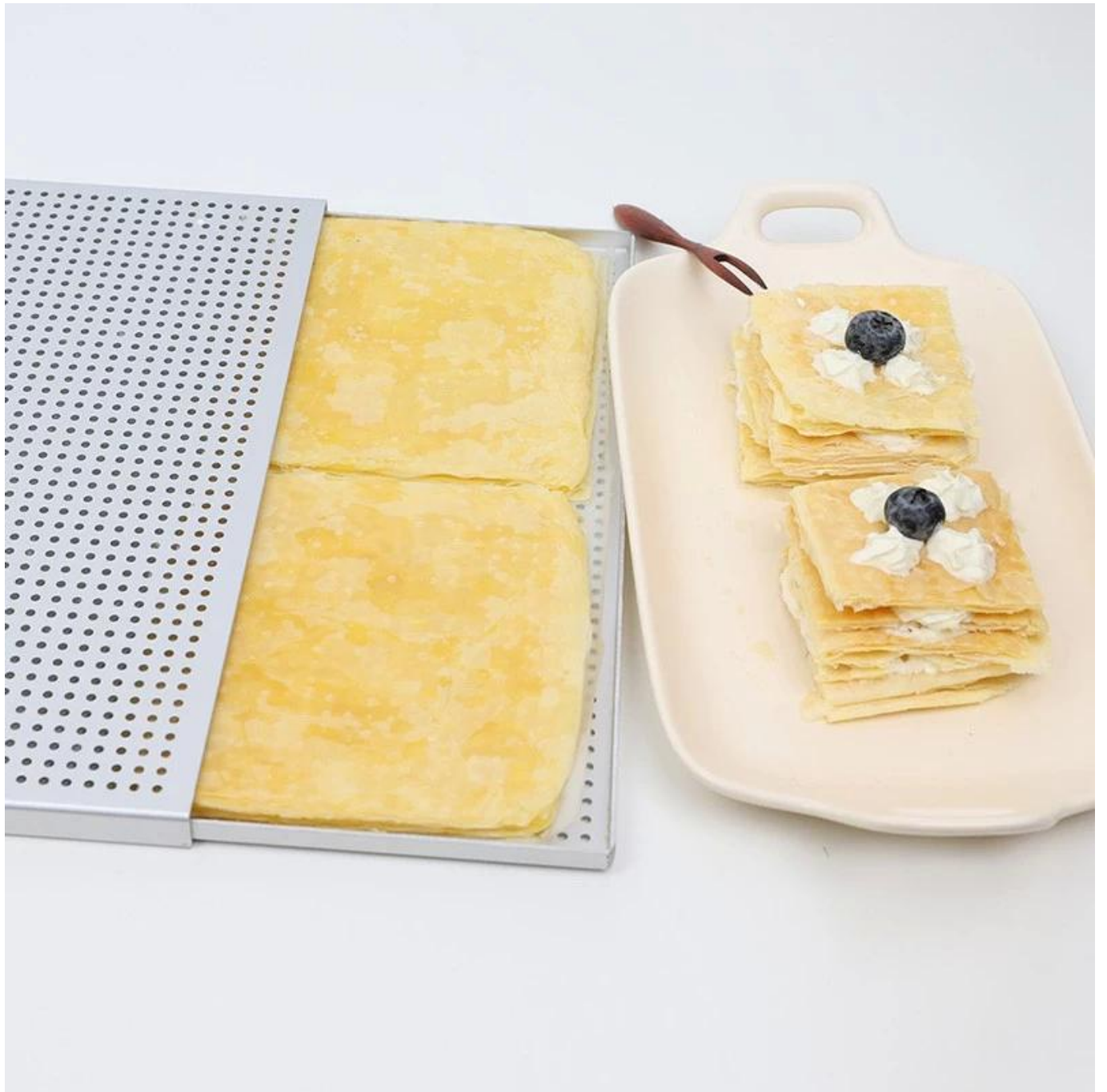







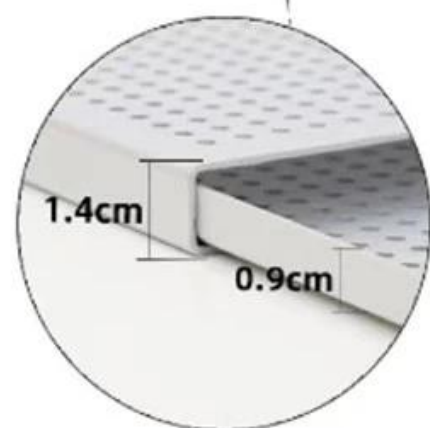

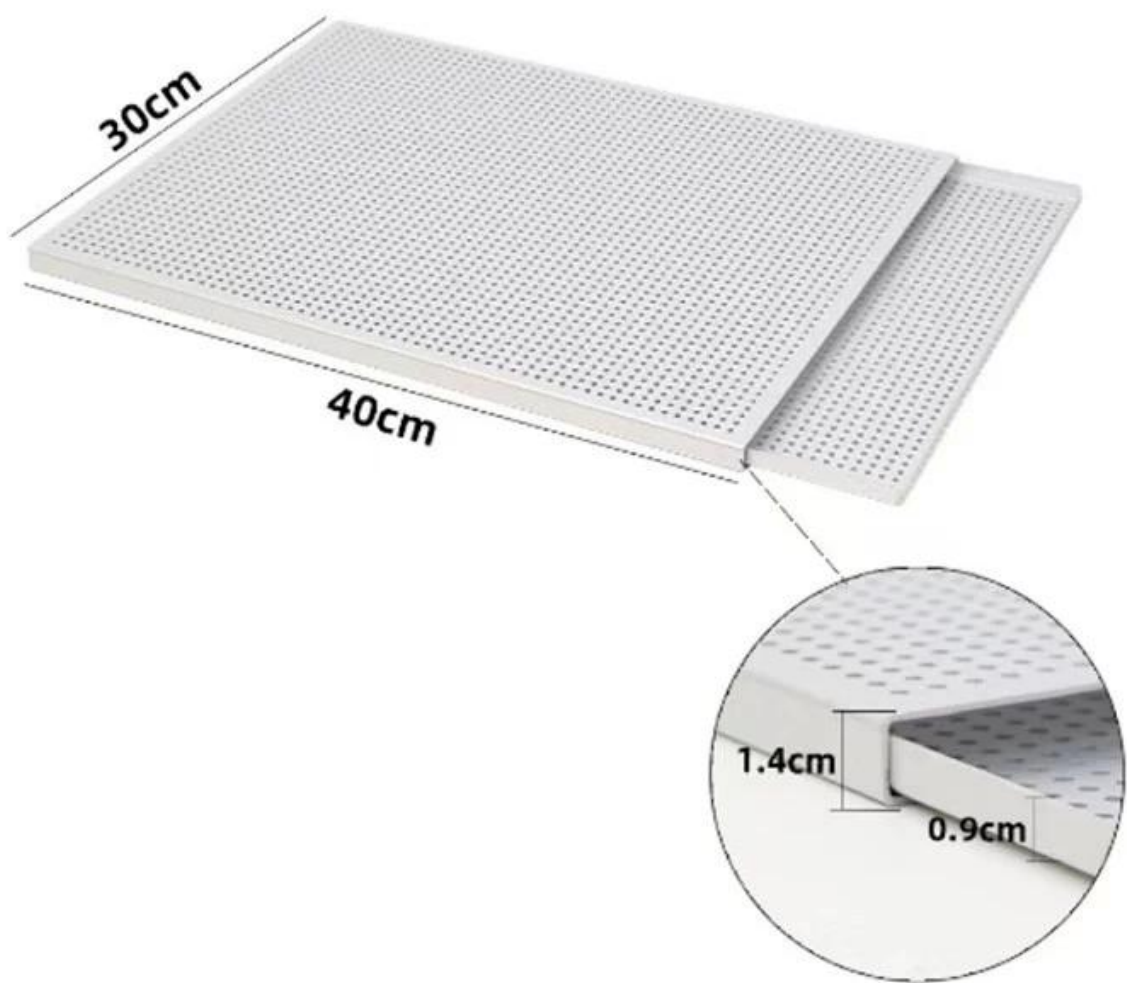

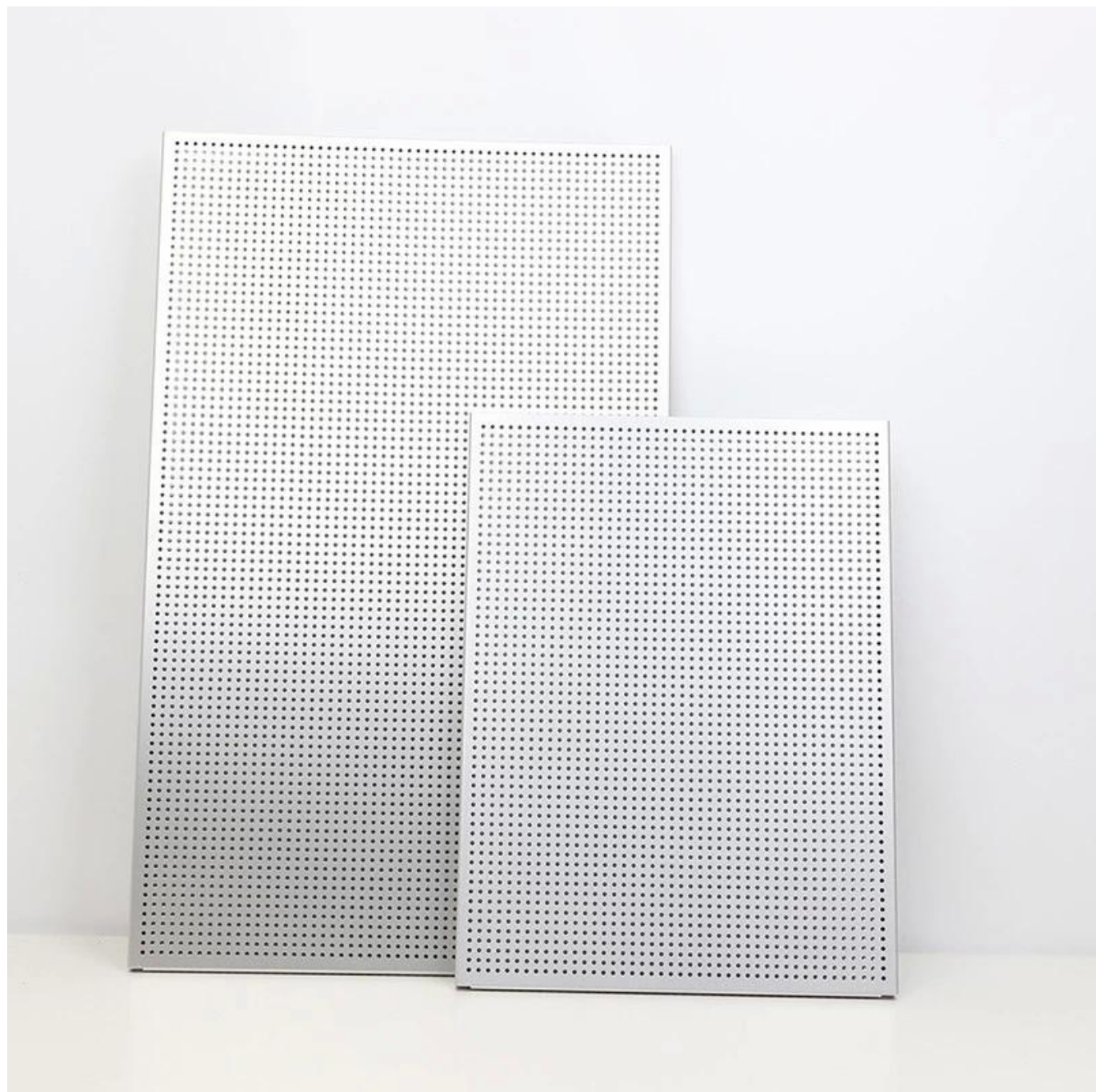



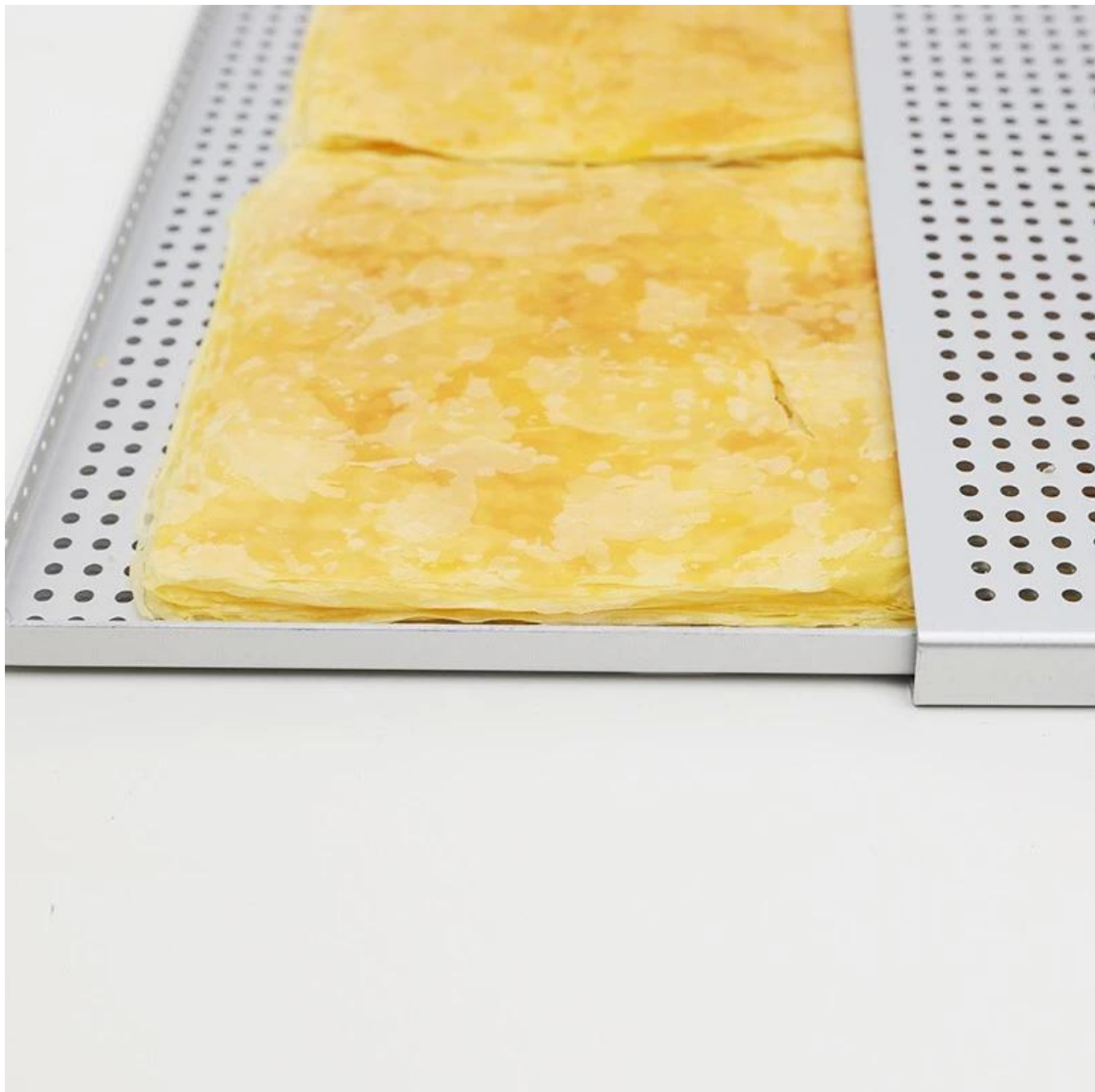

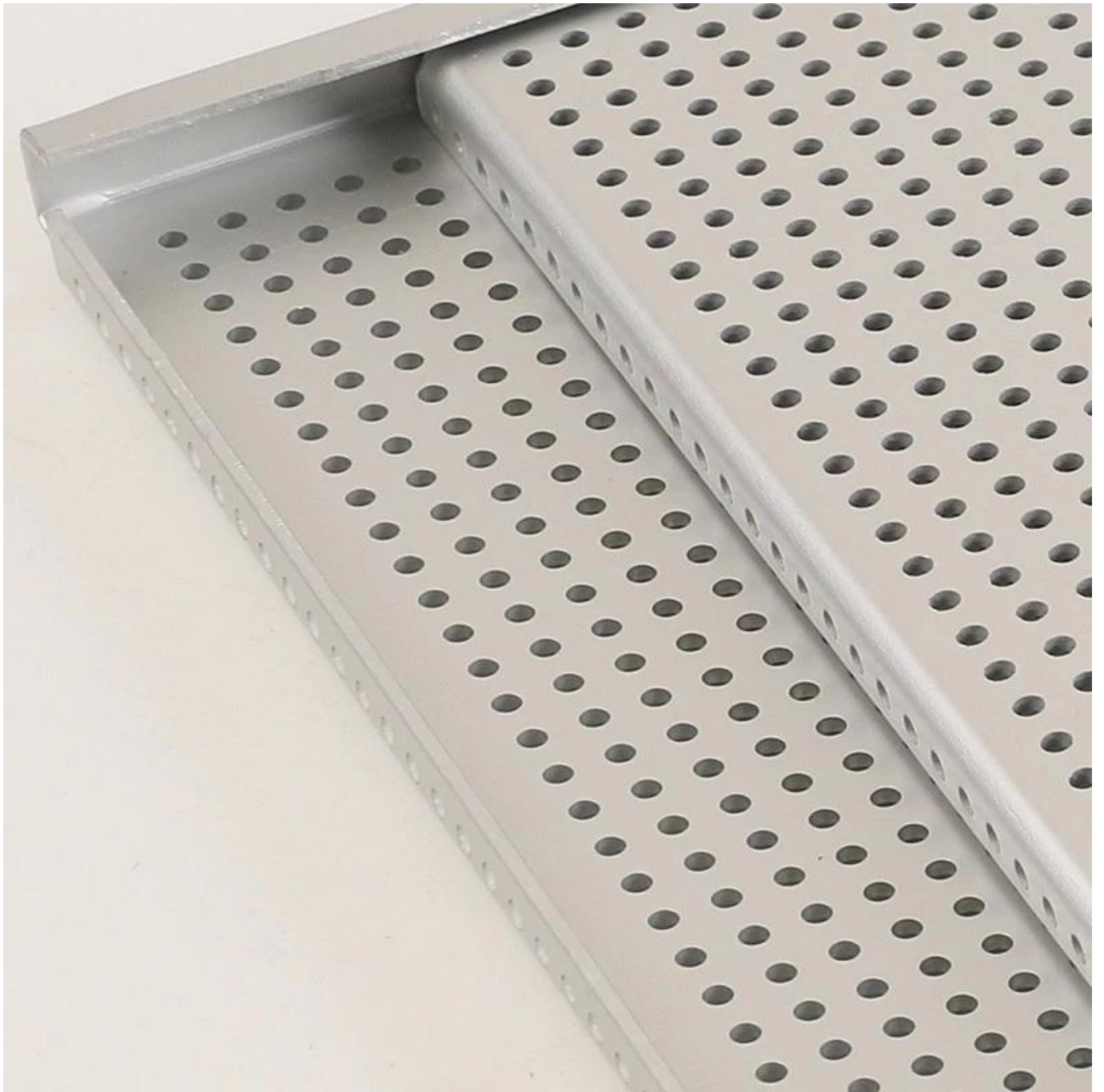



Integrated Machine Stamped Sheet Pans



wire rim



corrugated



perforated



nonstick



perforated



with bars



no wire rim



nonstick



right angel



nonstick



gold color



stainless steel

Handmade Sheet Pans



400*720mm



U-shaped



Square



nonstick



600*800mm



inclined edge

More Custom Baking Trays



sheet pan with lid

flat baking sheet

perforated tray with lid





Our Sheet Pan Workshop ODM & OEM Service

Well equipped with CNC machines, punching, cutting, moulding machines, our annual production ability has been over 150million US-dollars



MAIN PRODUCT

● Industry cup tray



● Baguette tray



● Sheet pan



● Bakery Trolley



● Bread pan set

