

CUSTOM Made 250g Non Stick Loaf PAN Toast Commercial Baking PAN

1. 2. 3. 4. 5.

1. 2. 3. 4. 5.

2. 3. 4. 5.

3. 4. 5.

4. 5.

5. Tsingbuy [250g Non Stick Loaf PAN](#) 15

1. 2. 3. 4. 5.













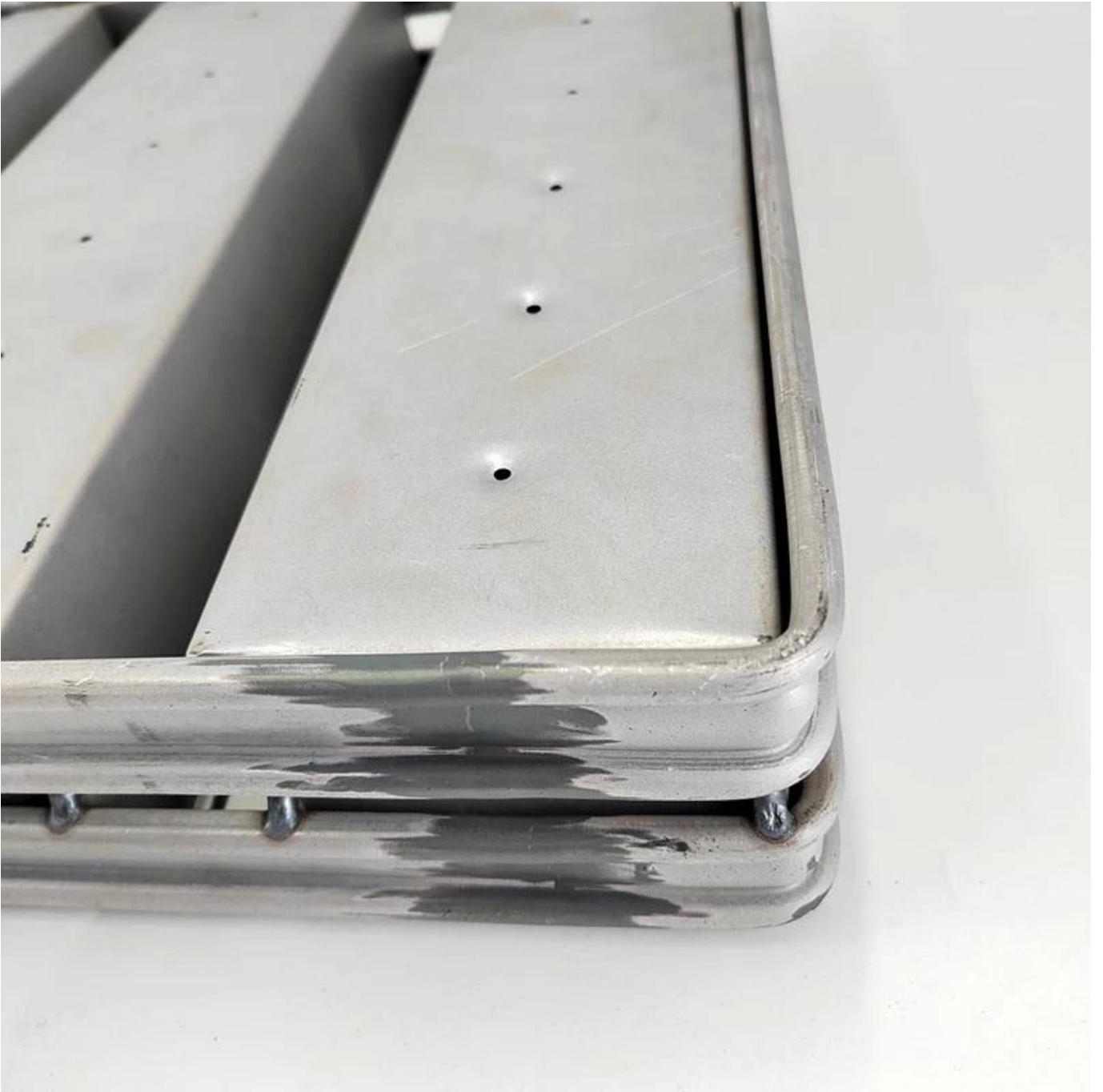

More Customized Strap Loaf Pans from Tsingbuy



Customized Single Loaf Pan

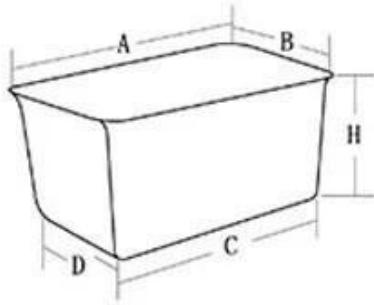

- A. Top length of the item
- B. Top width of the item
- C. Bottom length of the item
- D. Bottom width of the item
- H. Height

Customized Strapped Loaf Pan Sets

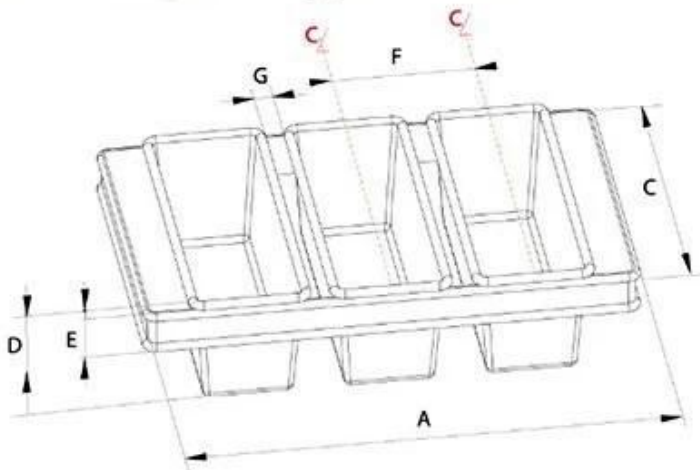

- A. Overall Length
- C. Overall Width
- D. Depth
- E. Frame Height
- F. Center-to-center
- G. Pan Distance



Flat handle



Frame handle



no handle

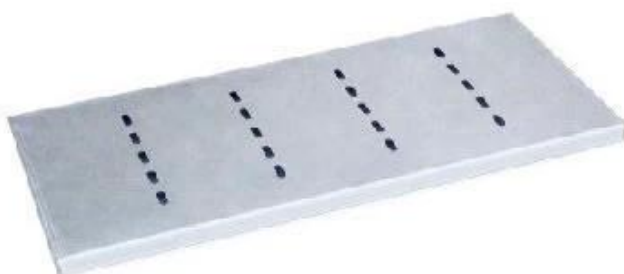

Matching lid (Drop Style)

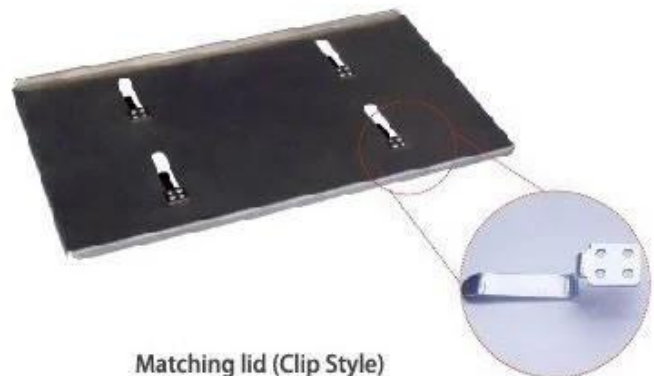

Matching lid (Clip Style)



Customized shape
Customized size
Rack matched

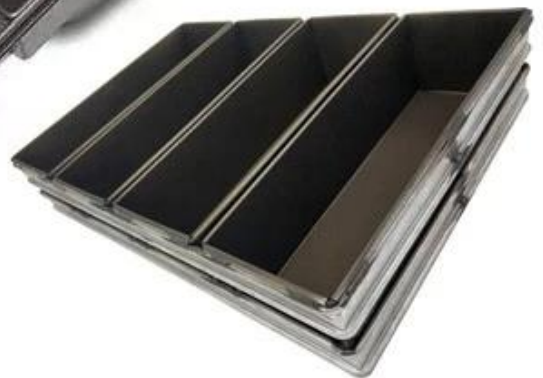

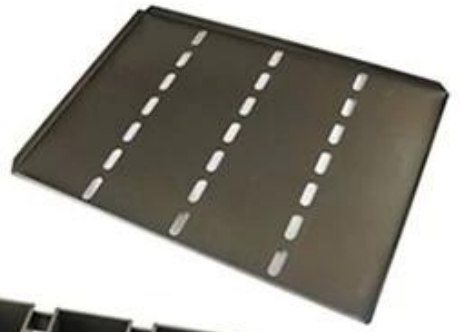

Procedures for custom made loaf baking pans

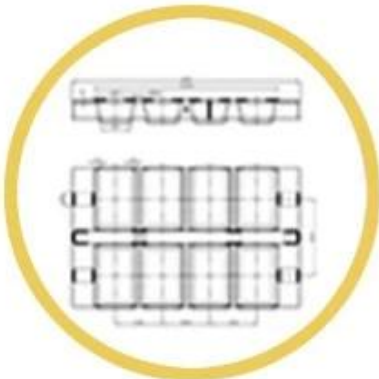

1. DRAWING



2. DESIGN



3. PRODUCT



6. SHIPPING



5. LOADING



4. PACKING

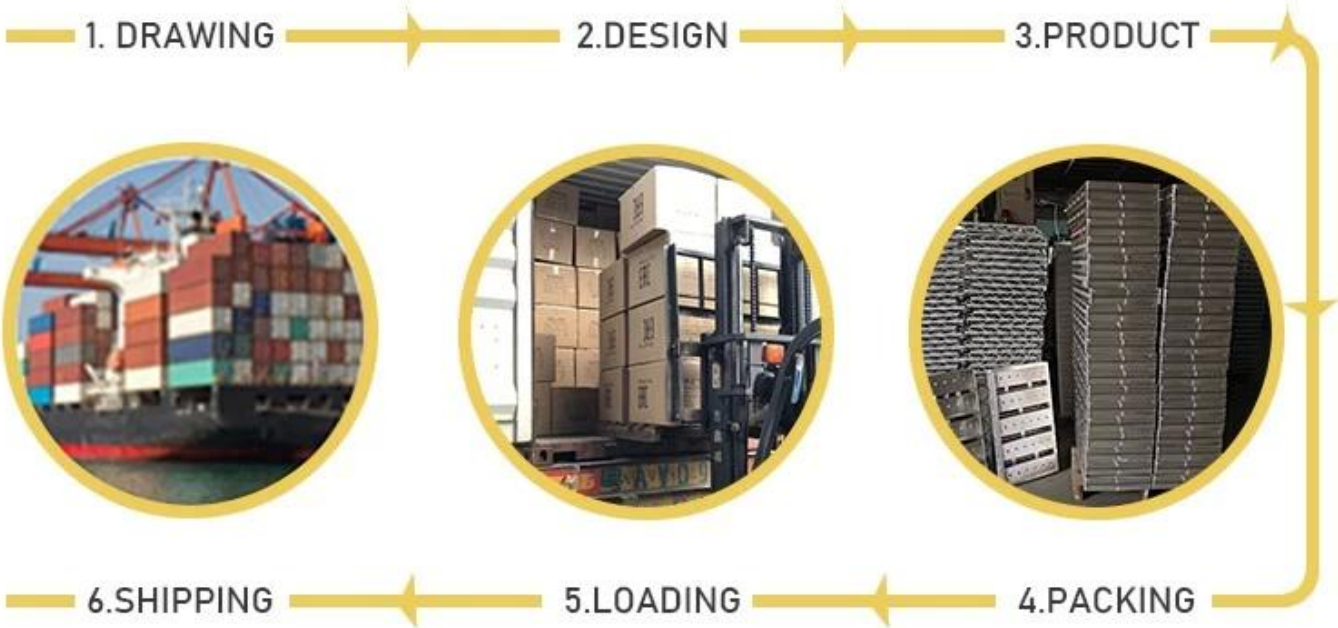



Custom Made Strap Loaf Pan Used with Bakery Trolley

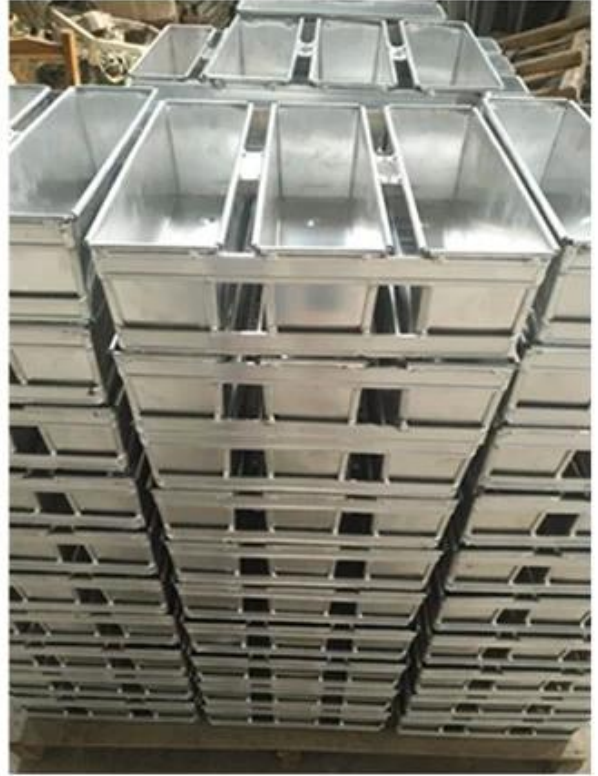

歡迎各界人士垂詢，電話：02-26523666，傳真：02-26523667，地址：桃園市龍潭區中正路100號。Tsingbuy www.tsingbuy.com





歡迎各界人士垂詢，Tsingbuy 專業生產各種鋁合金型材，品質優良，價格公道，歡迎各界人士垂詢。歡迎各界人士垂詢，Tsingbuy 專業生產各種鋁合金型材，品質優良，價格公道，歡迎各界人士垂詢。

