

# **Atacado Mini formas quadradas de alumínio antiaderente para pão pequeno**

## **Principais características das mini panelas de pão pequenas quadradas de alumínio antiaderente**

1. feito de liga de alumínio de 1,0 mm de espessura, durável para longa vida útil.
2. superfície antiaderente segura para alimentos não é pegajosa, fácil de desmoldar, fácil de limpar
3. projetado com capa, é conveniente fazer torradas americanas com lados planos. A superfície ondulada torna mais conveniente desmoldar.
4. O furo inferior é opcional para melhor circulação de ar quente e aquecimento uniforme.
5. O design do fio no aro o torna mais durável e não é fácil de deformar para uma longa vida útil.
6. Função múltipla para fazer sanduíches, torradas, pães tradicionais, etc.
7. ODM & OEM está disponível em Tsingbuy profissional [fornecedor de panela pequena](#).
8. Tsingbuy é um fornecedor profissional que orgulhosamente fabrica assadeiras de alta qualidade, formas de pão pullman e fornece assadeiras personalizadas para o mercado internacional há mais de 12 anos.

## **Imagens do produto de mini panelas de pão pequeno quadrado antiaderente de alumínio**

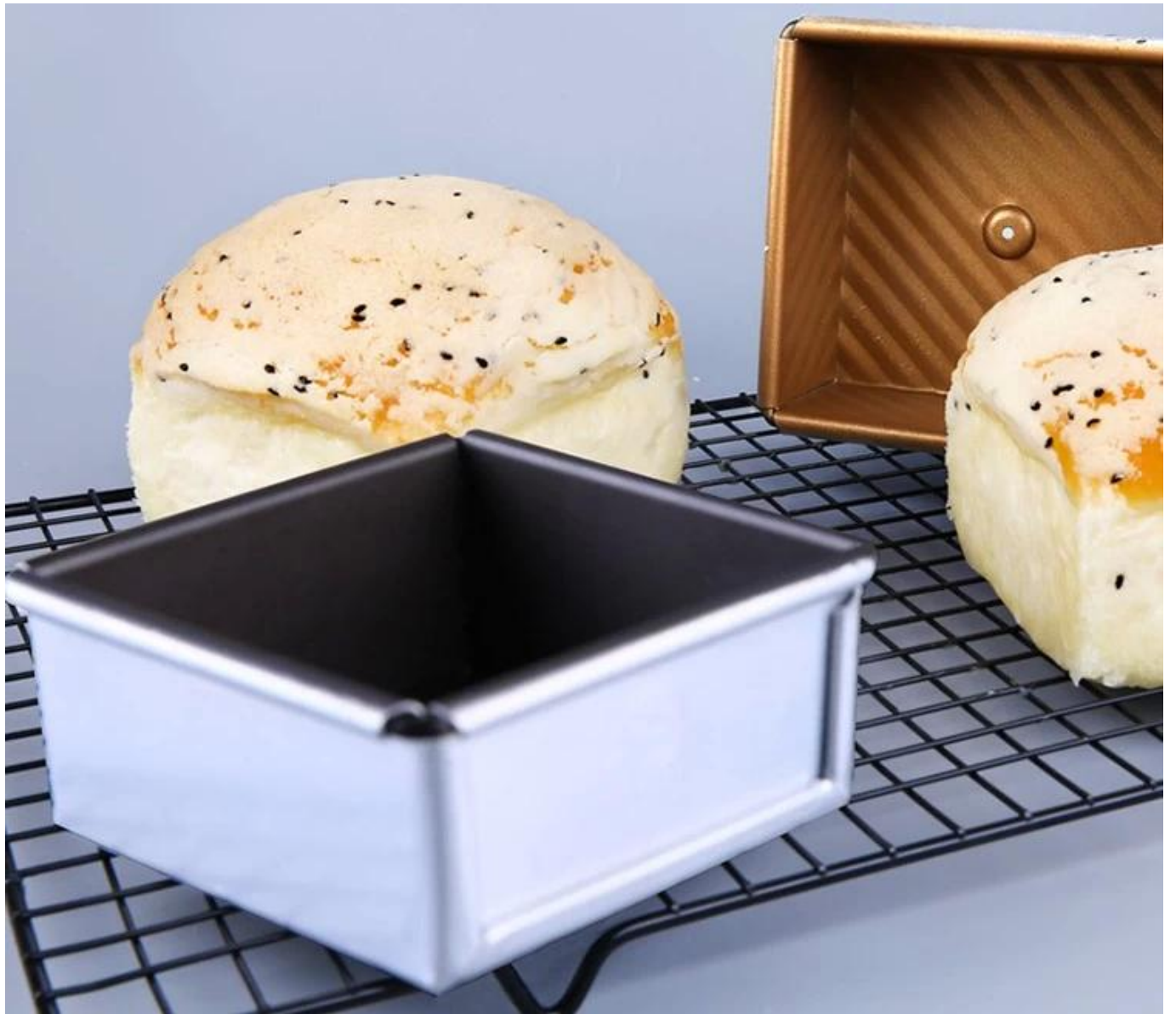

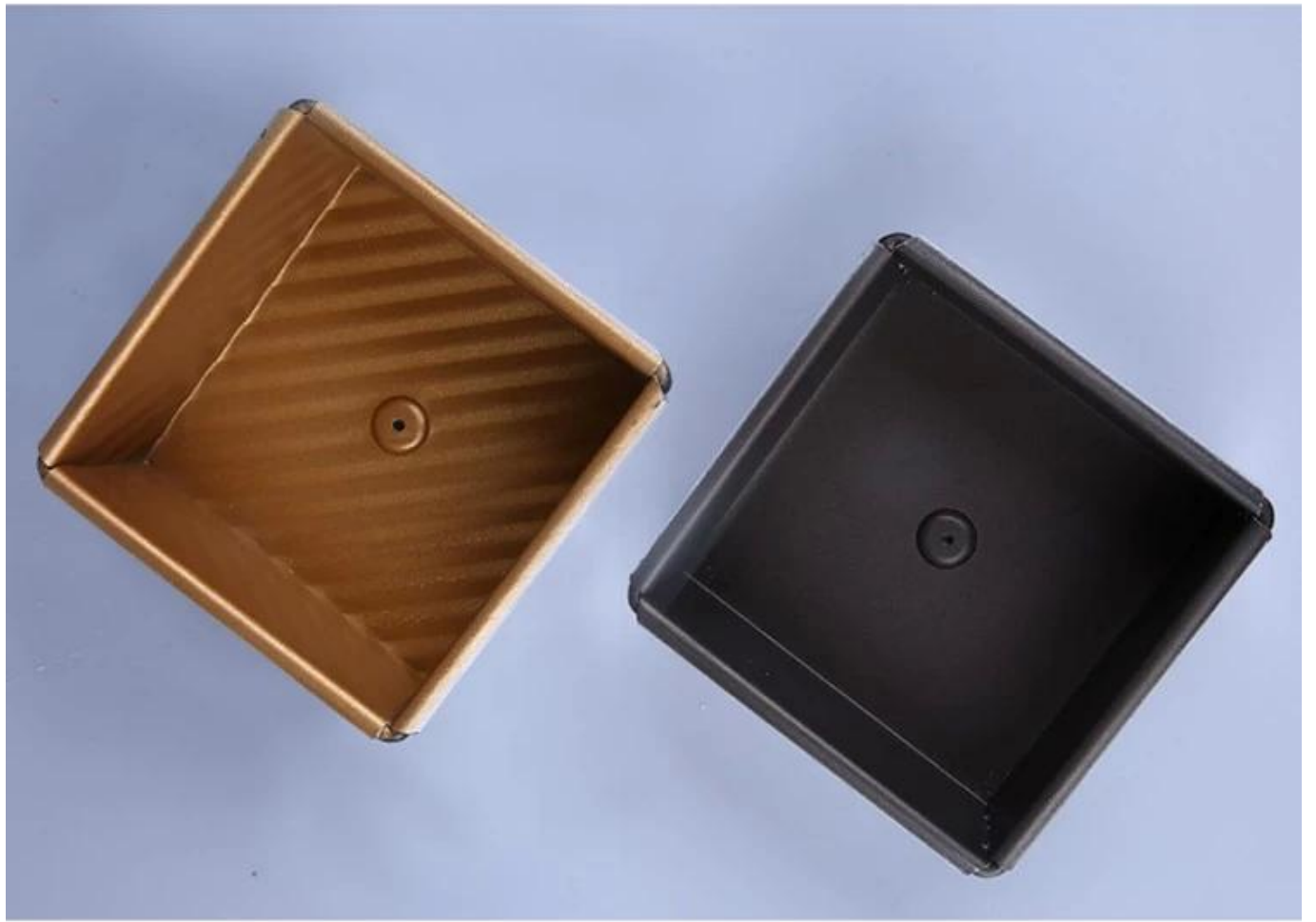



Aluminum  
Bread Baking Pan

1.0mm thick

Size

Top size

100x100x49mm

Bottom size

98x96mm

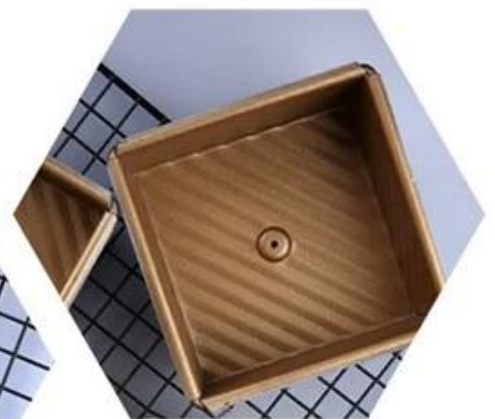













## Mais tipos de formas de pão e pão para sua informação

Aqui estão mais designs para formas de pão.

Nossas assadeiras Pullman são projetadas com estilo simples, bonitas e práticas com rápida condução de calor, aquecimento uniforme, não é fácil aparecer queima parcial.

Material opcional: alumínio, aço aluminizado, aço inoxidável

Opções de perfuração: sem perfuração, perfurada na parte inferior, totalmente perfurada

Usando cena: forma de pão único, forma de pão de alça

Opções de superfície: liso, corrugado, sem revestimento, antiaderente de teflon, antiaderente de silicone

Tamanho: qualquer tamanho

Tampa: com tampa ou não conforme sua exigência.

# customized single loaf pan





Além do mais [panela de pão antiaderente atacado](#), fabricação personalizada de bandeja de pão de cinta também é uma das nossas maiores forças, bem-vindo para mais informações.

Atuamos na fabricação de produtos para panificação há mais de 12 anos e fornecemos milhares de produtos para panificação para clientes internacionais. Usando nossa assadeira, você pode facilmente fazer todos os tipos de comida deliciosa, bolos de chiffon, bolo de mousse, bolo de libra, bolo de queijo, etc.

## More Customized Strap Loaf Pans from Tsingbuy



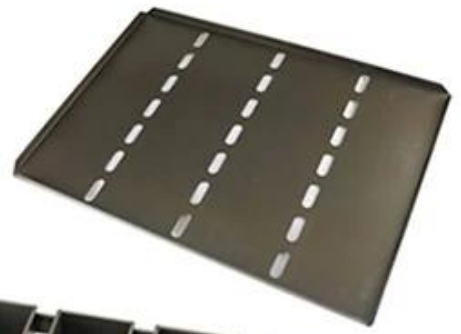

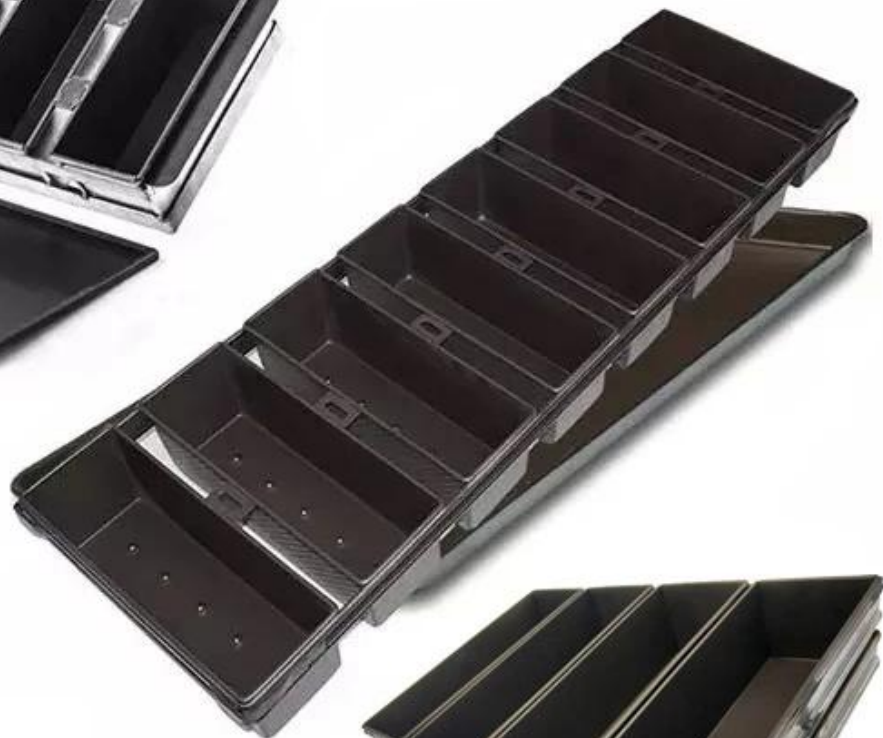

Customized shape  
Customized size  
Rack matched

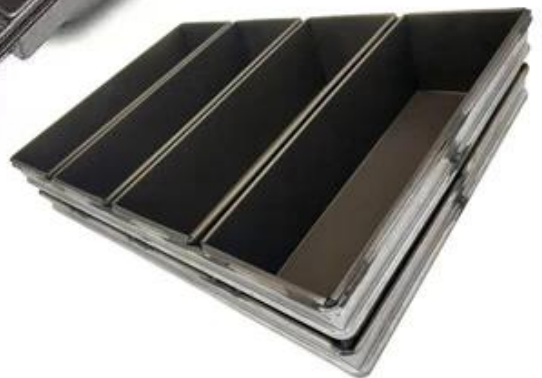

## Customized Single Loaf Pan

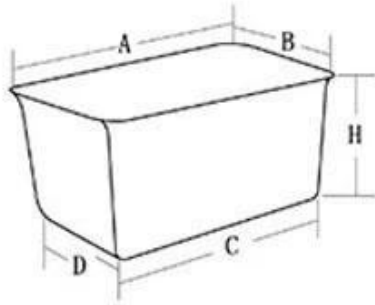

- A.Top length of the item
- B.Top width of the item
- C.Bottom length of the item
- D.Bottom width of the item
- H.Height

## Customized Strapped Loaf Pan Sets

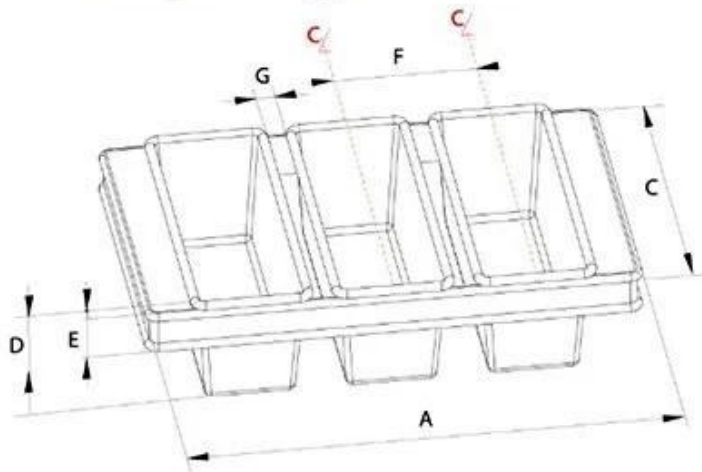

- A.Overall Length
- C.Overall Width
- D.Depth
- E.Frame Height
- F.Center-to-center
- G.Pan Distance



Flat handle



Frame handle



no handle



Matching lid (Drop Style)

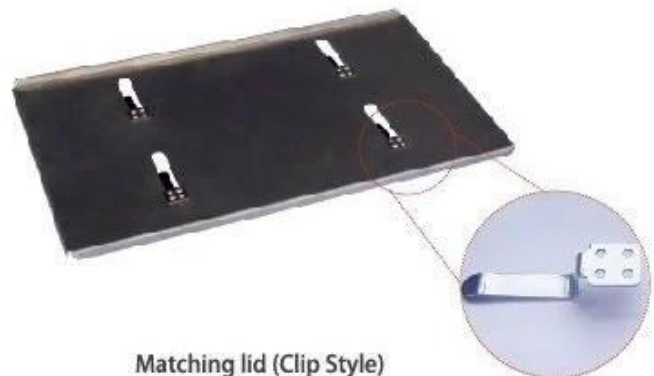

Matching lid (Clip Style)

## Fotos de fábrica

Tsingbuy [fábrica de pão quadrado](#) também produz assadeira, forma de pão, forma de baguete, assadeira de cupcake, forma de bolo etc para padarias, fábricas de alimentos, restaurantes para uso comercial. O serviço ODM&OEM é a nossa maior força. Bem-vindo a entrar em contato conosco se você estiver procurando por assadeiras comerciais.



### Loaf Pan

Tsingbuy Industry Limited





