

Atacado Alta Qualidade 190/210/250/300/385/450g Tamanhos Pequenos Alumínio Antiaderente Pão Assadeira Pullman Pão frigideiras Com Tampa

Principais características de 190/210/250/300/385/450g de alumínio de tamanhos pequenos assadeiras de pão de forma

1. feito de 1,0 mm de espessura Liga de alumínio , .
2. A superfície antiaderente à prova de ood não é pegajosa, fácil de desmoldar, fácil de limpar
3. projetado com capa, é conveniente fazer torradas americanas com .
4. O furo inferior é opcional para melhor.
5. O design do fio no aro o torna mais durável e não é fácil de deformar para uma longa vida útil.
6. Função múltipla para fazer sanduíches, torradas, pães tradicionais etc.
7. ODM & OEM está disponível em Tsingbuy profissional [fabricante de painéis de alumínio](#).
8. Tsingbuy é um fornecedor profissional que orgulhosamente fabrica assadeiras de alta qualidade, formas de pão pullman e fornece assadeiras personalizadas para o mercado internacional há mais de 12 anos.

Imagens do produto de 190/210/250/300/385/450g de alumínio de tamanhos pequenos assadeiras de pão

Aluminum Non Stick Bread Loaf Pan







190g non stick loaf pan



210g non stick loaf pan



250g non stick loaf pan

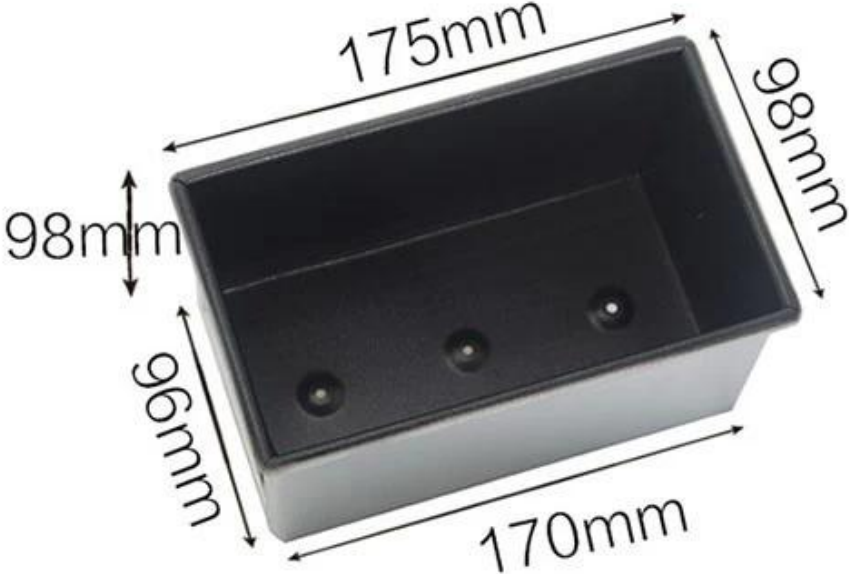

300g non stick loaf pan

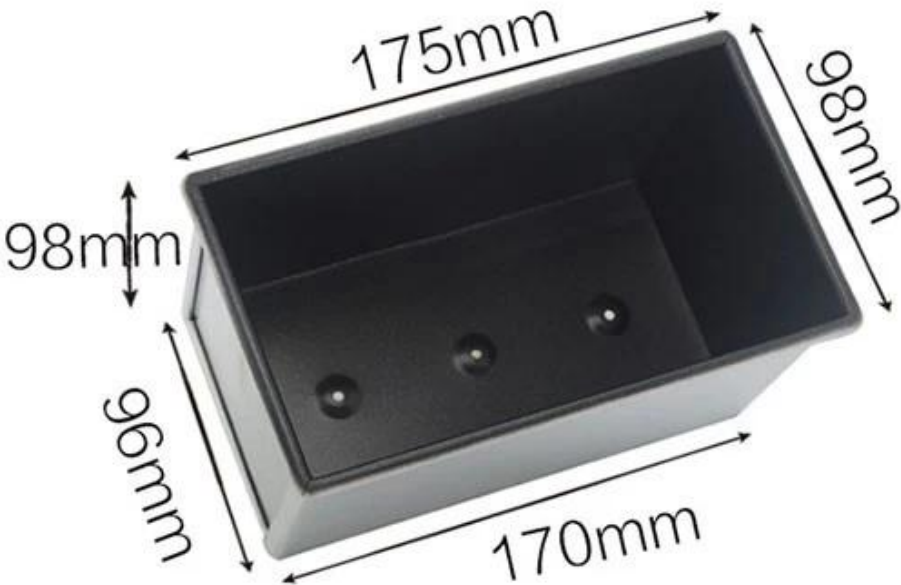

385g non stick loaf pan



450g non stick loaf pan

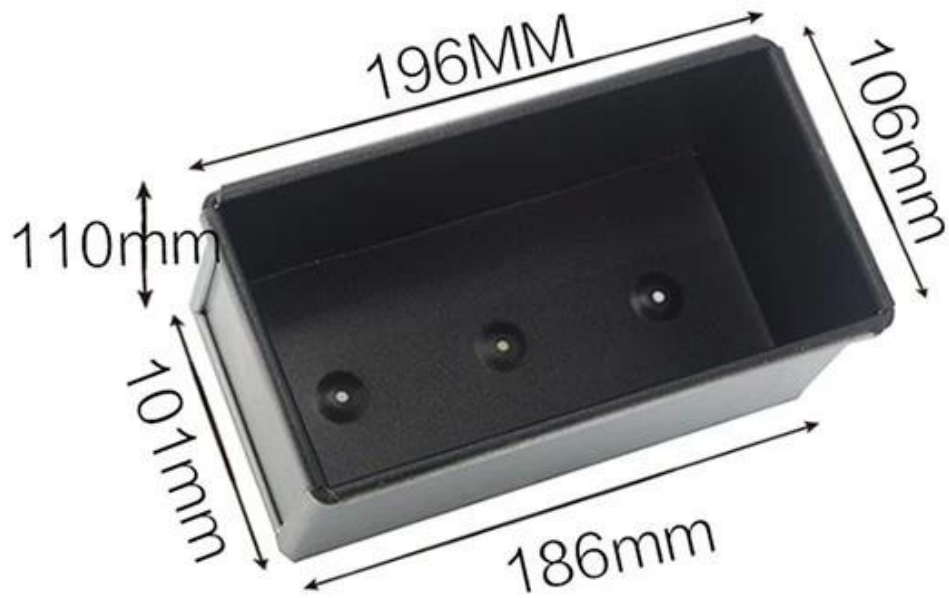

Cover for 250g loaf pan



Cover for 300g loaf pan

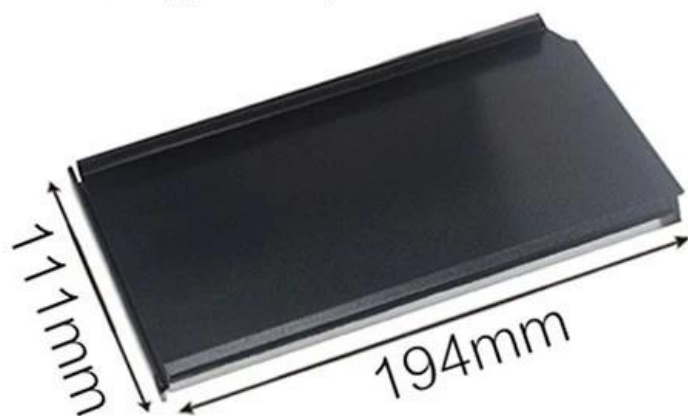

Cover for 450g loaf pan



Mais tipos de formas de pão e pão para sua informação

Aqui estão mais designs para [assadeira de pão atacado](#).

Nossas formas de pão Pullman são projetadas com o estilo simples, bonito e prático e com condução de calor rápida, aquecimento uniforme, não é fácil de aparecer parcial chamuscar.

Material opcional: alumínio, aço aluminizado, aço inoxidável

Opções de perfuração: sem perfuração, perfurada na parte inferior, totalmente perfurada

Usando cena: forma de pão único, forma de pão de alça

Opções de superfície: liso, corrugado, sem revestimento, Teflon antiaderente, antiaderente de silicone

Tamanho: qualquer tamanho

Tampa: com tampa ou não conforme sua exigência.

customized single loaf pan





Teflon coating

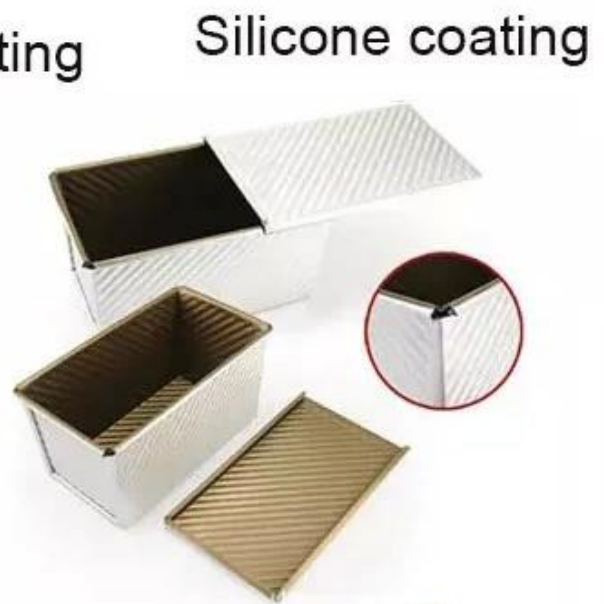

Silicone coating



Material:

Aluminum alloy

Aluminized steel

Personalizado fabricação de bandeja de pão de cinta é uma das nossas maiores forças, bem-vindo para mais informações. Atuamos na fabricação de produtos para panificação há mais de 12 anos e fornecemos milhares de produtos para panificação para clientes internacionais. Usando nosso cozimento pan , você pode facilmente fazer todos os tipos de comida deliciosa, Chiffon bolos, bolo de mousse, Libra bolo, bolo de queijo, etc

More Customized Strap Loaf Pans from Tsingbuy



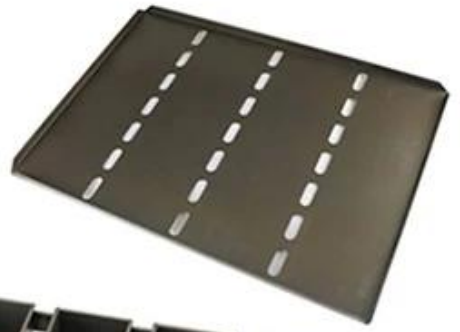

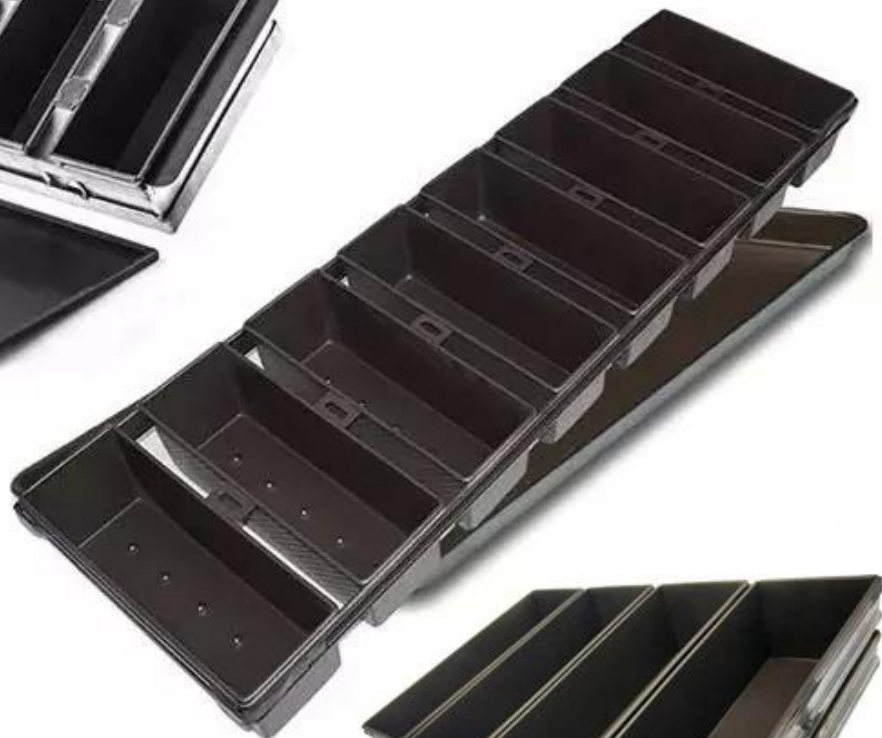

Customized shape
Customized size
Rack matched

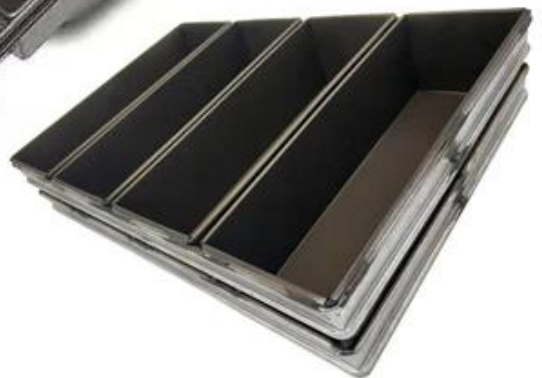

Customized Single Loaf Pan

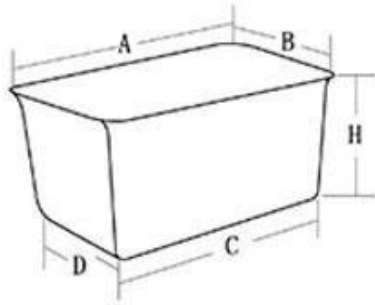

- A.Top length of the item
- B.Top width of the item
- C.Bottom length of the item
- D.Bottom width of the item
- H.Height

Customized Strapped Loaf Pan Sets

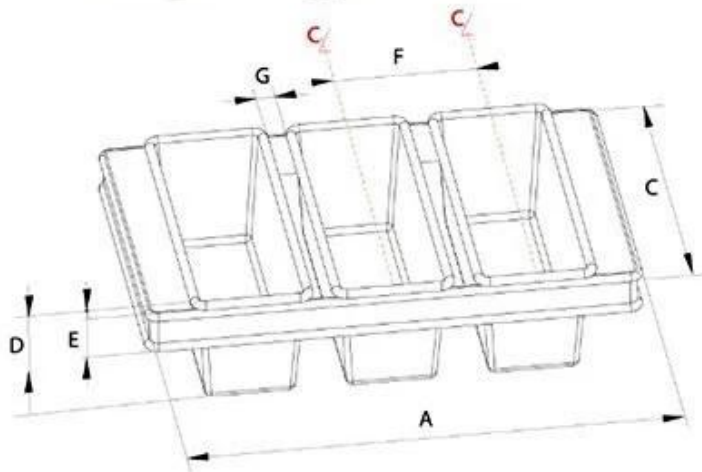

- A.Overall Length
- C.Overall Width
- D.Depth
- E.Frame Height
- F.Center-to-center
- G.Pan Distance



Flat handle



Frame handle



no handle



Matching lid (Drop Style)

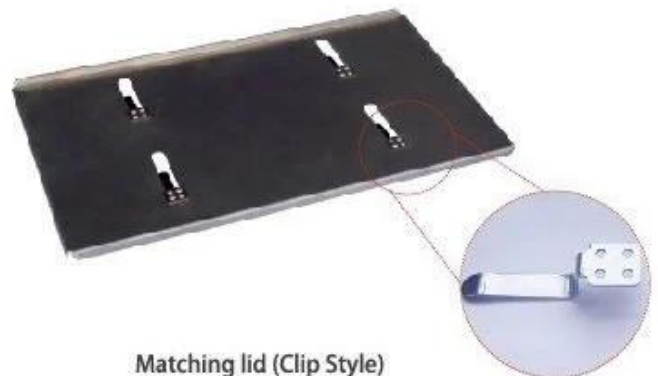

Matching lid (Clip Style)

Fotos de fábrica

Tsingbuy [fornecedor de painéis de pão pequenas](#) também produz assadeira, forma de pão, forma de baguete, assadeira de cupcake, forma de bolo etc para padarias, fábricas de alimentos, restaurantes para uso comercial. O serviço ODM&OEM é a nossa maior força.

Bem-vindo a entrar em contato conosco se você estiver procurando por assadeiras comerciais.



Loaf Pan

Tsingbuy Industry Limited



