

# Moldes de lata de cozimento de pão aluminizado resistentes personalizados para uso comercial e industrial

## **Principais características da assadeira de pão com tira de aço aluminizada personalizada**

1. Criado a partir de 0,8/1,0/1,2/1,5 pesado calibre aço aluminizado com barras de reforço duplas em toda a panela.
2. Capaz de assar 3/4/5/6/8 pães rapidamente enquanto ainda mantém a qualidade do cozimento do pão.
3. Disponível em uma variedade de tamanhos, em configurações para atender a todos os fornos industriais/comerciais.
4. Revestido com esmalte de PTFE/Silicone para garantir uma boa aparência de pão, não grudando na panela. O revestimento antiaderente é adequado para contato com alimentos e tem desempenho mais duradouro. Ele também reduz o óleo ao assar e economiza seu tempo de limpeza e trabalho.
4. Tsingbuy [fabricante de forma de pão de aço aluminizado](#) fornece "projeto-amostra"confirmação-lote"produção"serviço"com"mais"então"15"anos"de"ODM&OEM"experiência.

## **Imagens do produto de Assadeira de pão com tira de aço aluminizada personalizada**

Tsingbuy é profissional dentro fazer Ambas solteiro pão frigideira e alça pão panelas. Aqui nós compartilhar algum modelos de forma de pão de cinta para sua referência. A maioria das formas de pão de cinta são projetadas de acordo com os requisitos.

## More Customized Strap Loaf Pans from Tsingbuy



## Customized Single Loaf Pan

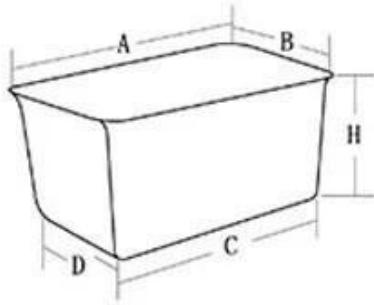

- A. Top length of the item
- B. Top width of the item
- C. Bottom length of the item
- D. Bottom width of the item
- H. Height

## Customized Strapped Loaf Pan Sets

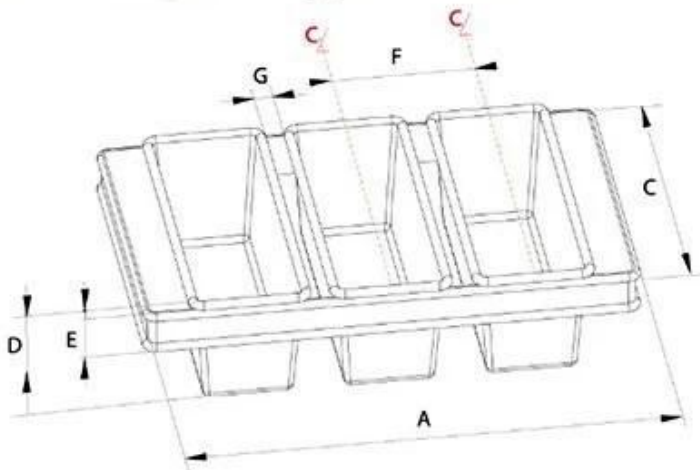

- A. Overall Length
- C. Overall Width
- D. Depth
- E. Frame Height
- F. Center-to-center
- G. Pan Distance



Flat handle



Frame handle



no handle



Matching lid (Drop Style)

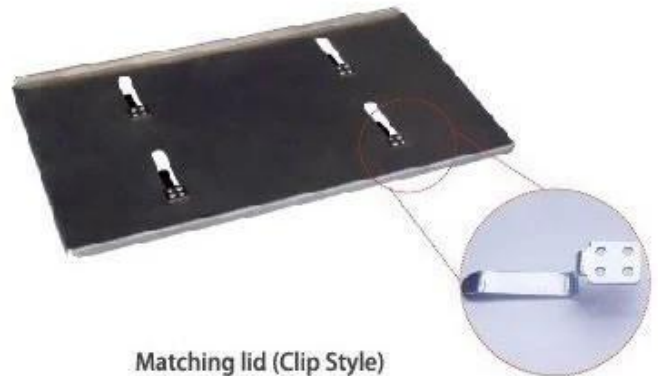

Matching lid (Clip Style)



Customized shape  
Customized size  
Rack matched

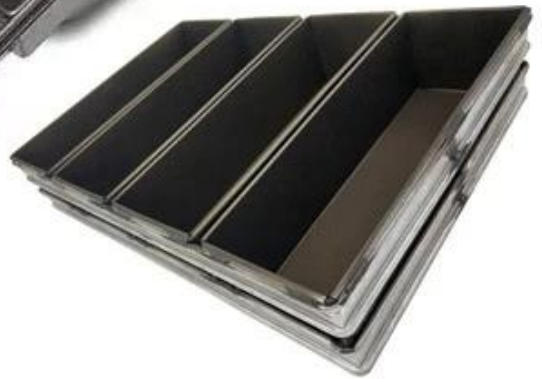

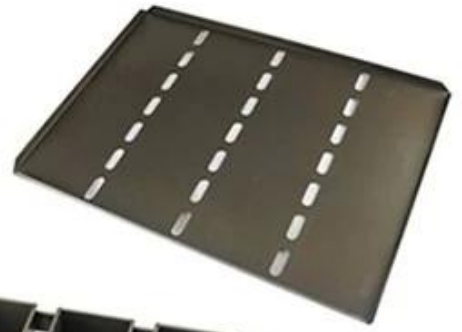



## Procedures for custom made loaf baking pans

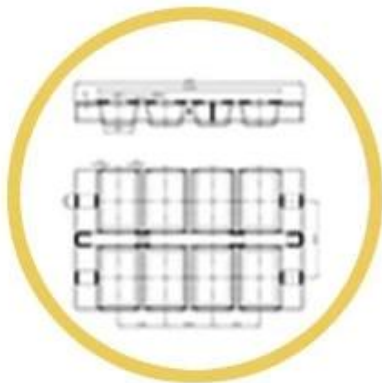

1. DRAWING



2. DESIGN



3. PRODUCT



6. SHIPPING



5. LOADING



4. PACKING

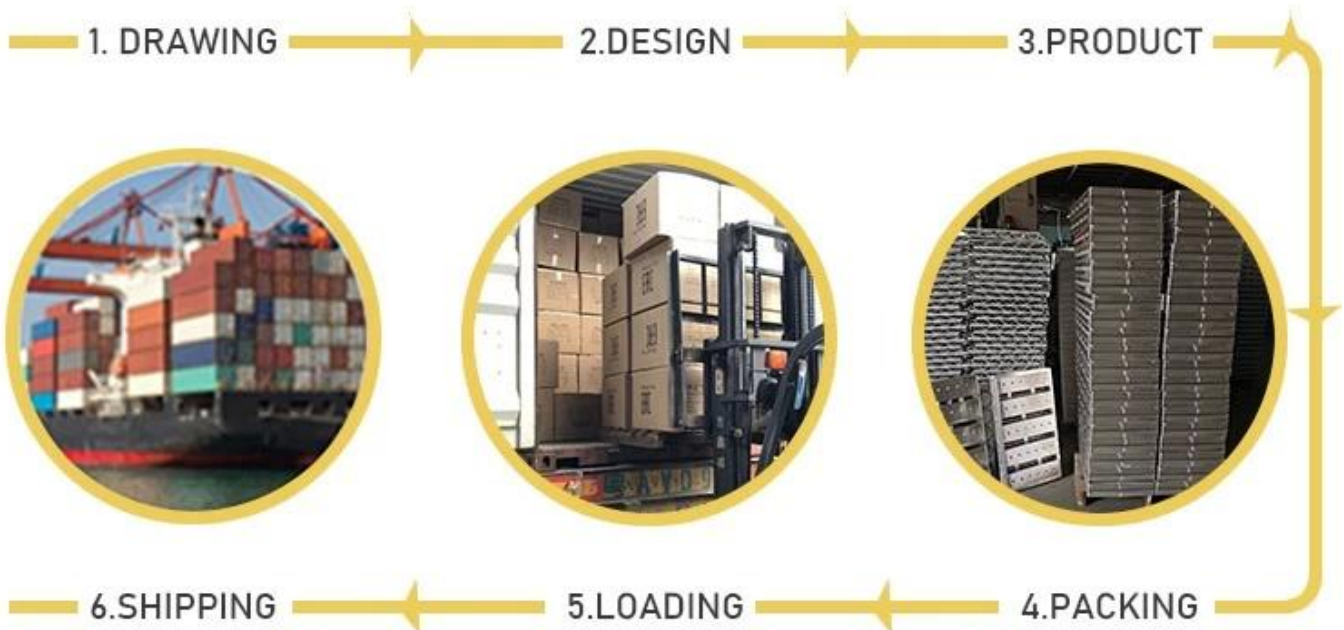



## Custom Made Strap Loaf Pan Used with Bakery Trolley



**Mais tipos de assadeira de pão simples para cozinha doméstica, padaria, restaurante etc.**

Aqui estão alguns modelos clássicos de assadeira de pão simples da Tsingbuy [fornecedor de lata de pão](#).

# Single Loaf Pan



natural surface



corrugated



full perforation



nonstick



corrugated



golden color



holes at bottom



full perforation



custom size



Imagens de fábrica do produtor de forma de pão Tsingbuy







Além do mais [lata de pão da china por atacado](#), O fabricante de assadeiras Tsingbuy também fornece design personalizado e venda por atacado de outras assadeiras comerciais, como assadeiras, assadeiras de baguete, assadeiras de pão, assadeiras de vários moldes, carrinhos de padaria, assadeiras de bolo, etc.

