

Conjunto de moldes de lata de aço aluminizado feito sob medida para uso industrial com 10 cavidades para torradas e sanduíches

Principais características do conjunto de assadeira de pão de aço aluminizado personalizado com 10 cavidades e alça antiaderente

1. Esta assadeira de pão comercial é capaz de conter (10) pães, cada caixa com tamanho de 165x80mm. Este produto permite produzir dez pães para vender ou servir rapidamente, mantendo a qualidade da panificação. Se você precisa fazer seus pães de jantar exclusivos ou pães sazonais, esta forma de pão é uma boa escolha para ajudá-lo a terminar seu trabalho de cozimento com facilidade.
2. As formas de pão são fabricadas em alumínio de 0,7/1,0/1,2 mmaço ed com cantos duplos dobrados, a borda de e cada panela é equipado com um fio de aro de 5 mm de diâmetro. os quadros são fabricados de 1,2mm aluminizaço fundido para super suporte e durabilidade. A superfície das panelas de pão são acabamento canelado e vêm com orifícios de vapor. Não é adequado para misturas sem glúten.
3. Este pão de ló forma de pão é fabricado em China [grande fabricante de panelas de pão](#) - Tsingbuy Industry Limited. Isto está disponível em uma variedade de tamanhos, em várias configurações para atender todos os fornos industriais, comerciais ou domésticos.

Imagens do produto de Conjunto de assadeira de pão de aço aluminizado personalizado com 10 cavidades e alça antiaderente









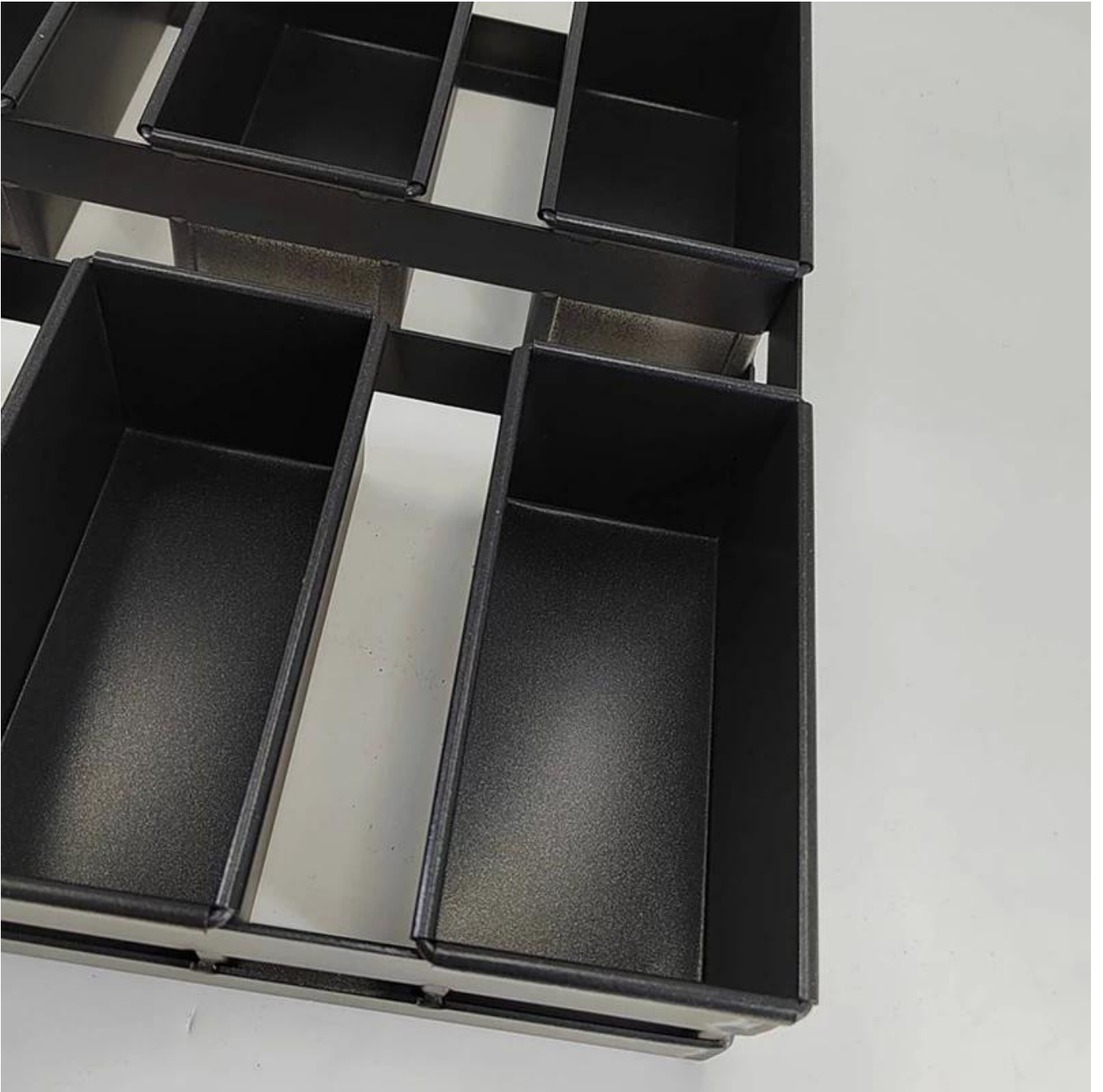



Tsingbuy is profissional em fazendo ambos solteiro pão frigideira e alça pão panelas. Aqui nós compartilhar alguns modelos de forma de pão de cinta para sua referência. A maioria das formas de pão de cinta são projetadas de acordo com os requisitos.

More Customized Strap Loaf Pans from Tsingbuy



Customized Single Loaf Pan

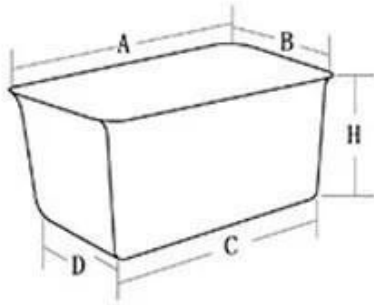

- A. Top length of the item
- B. Top width of the item
- C. Bottom length of the item
- D. Bottom width of the item
- H. Height

Customized Strapped Loaf Pan Sets

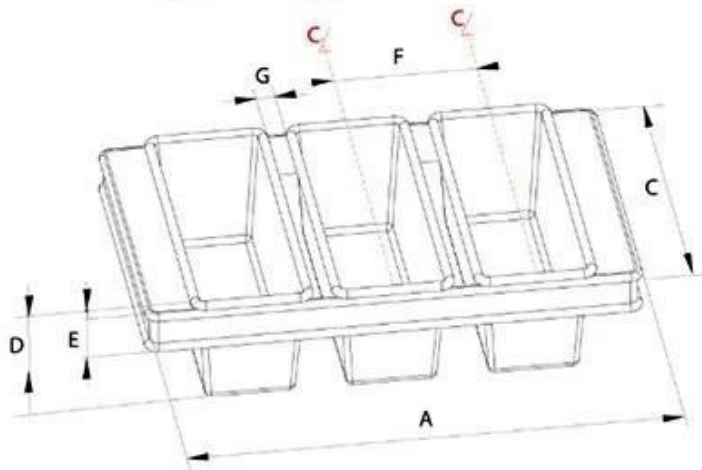

- A. Overall Length
- C. Overall Width
- D. Depth
- E. Frame Height
- F. Center-to-center
- G. Pan Distance



Flat handle



Frame handle



no handle



Matching lid (Drop Style)

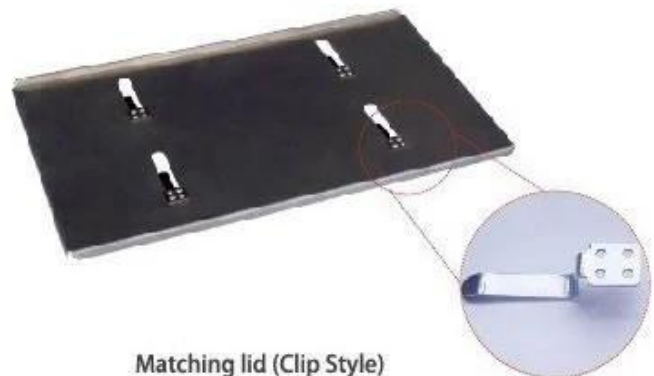

Matching lid (Clip Style)

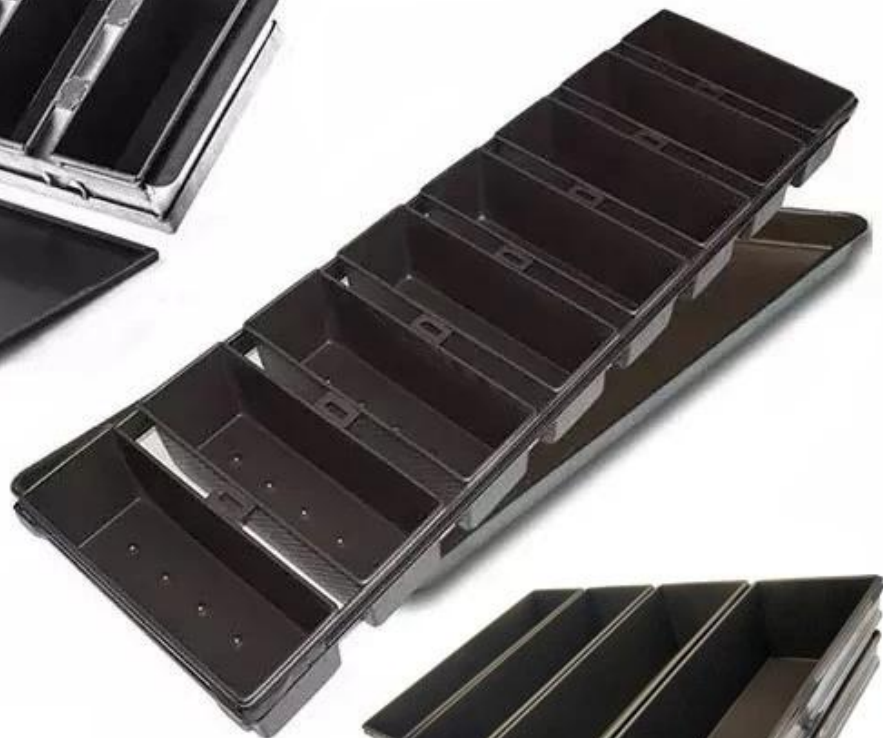

Customized shape
Customized size
Rack matched

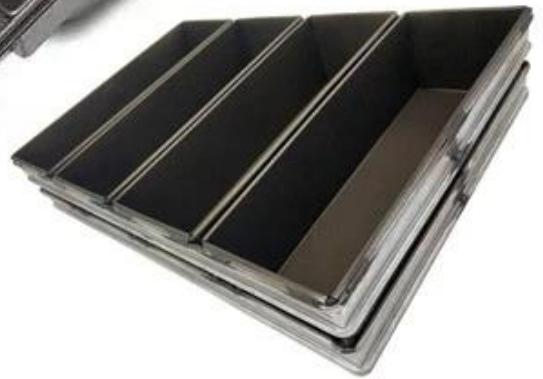

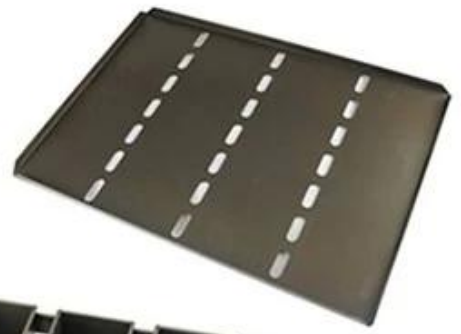

Procedures for custom made loaf baking pans

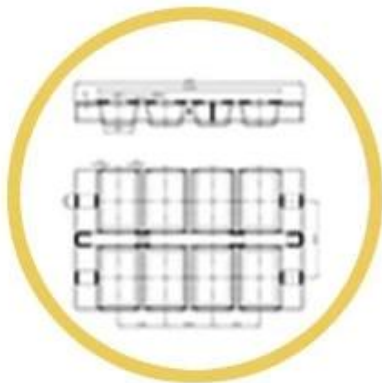

1. DRAWING



2. DESIGN



3. PRODUCT



6. SHIPPING



5. LOADING



4. PACKING



Custom Made Strap Loaf Pan Used with Bakery Trolley



Mais tipos de assadeira de pão simples para cozinha doméstica, padaria, restaurante etc.

Aqui estão alguns modelos clássicos de assadeira de pão simples da Tsingbuy [fornecedor de forma de pão antiaderente](#).

Single Loaf Pan



natural surface



corrugated



full perforation



nonstick



corrugated



golden color



holes at bottom



full perforation



custom size



Imagens de fábrica do produtor de forma de pão Tsingbuy





Além do mais [forma de pão atacado](#), O fabricante de assadeiras Tsingbuy também fornece design personalizado e venda por atacado de outras assadeiras comerciais, como assadeiras, assadeiras de baguete, assadeiras de pão, assadeiras de moldes múltiplos, carrinho de padaria, assadeiras de bolo etc. consulte-nos a qualquer momento.

