

Champagne Gold Color Nonstick Aluminum Square Bread Toast Baking Pan Mini Loaf Pan with Lid

Main features of mini square loaf bread pan with lid

1. Constructed with 1.0mm aluminum alloy for better and evenly heat conductivity.
2. Smooth surface and corrugated surface is optional. The hole at the bottom allows better air circulation and baking performance.
3. Gold-colored non-stick coating is fashionable and food-safe, for easier demoulding of loaf bread.
4. Wire in rim design makes it more durable and not easy to deformation for long service life.
5. Multiple function for making sandwiches, toast, traditional loaf breads etc.
6. 6cm and 10cm is optional. Custom size as your requirements is welcomed in Tsingbuy [mini loaf pan manufacturer](#).

Product images of mini aluminum loaf bread pan with lid

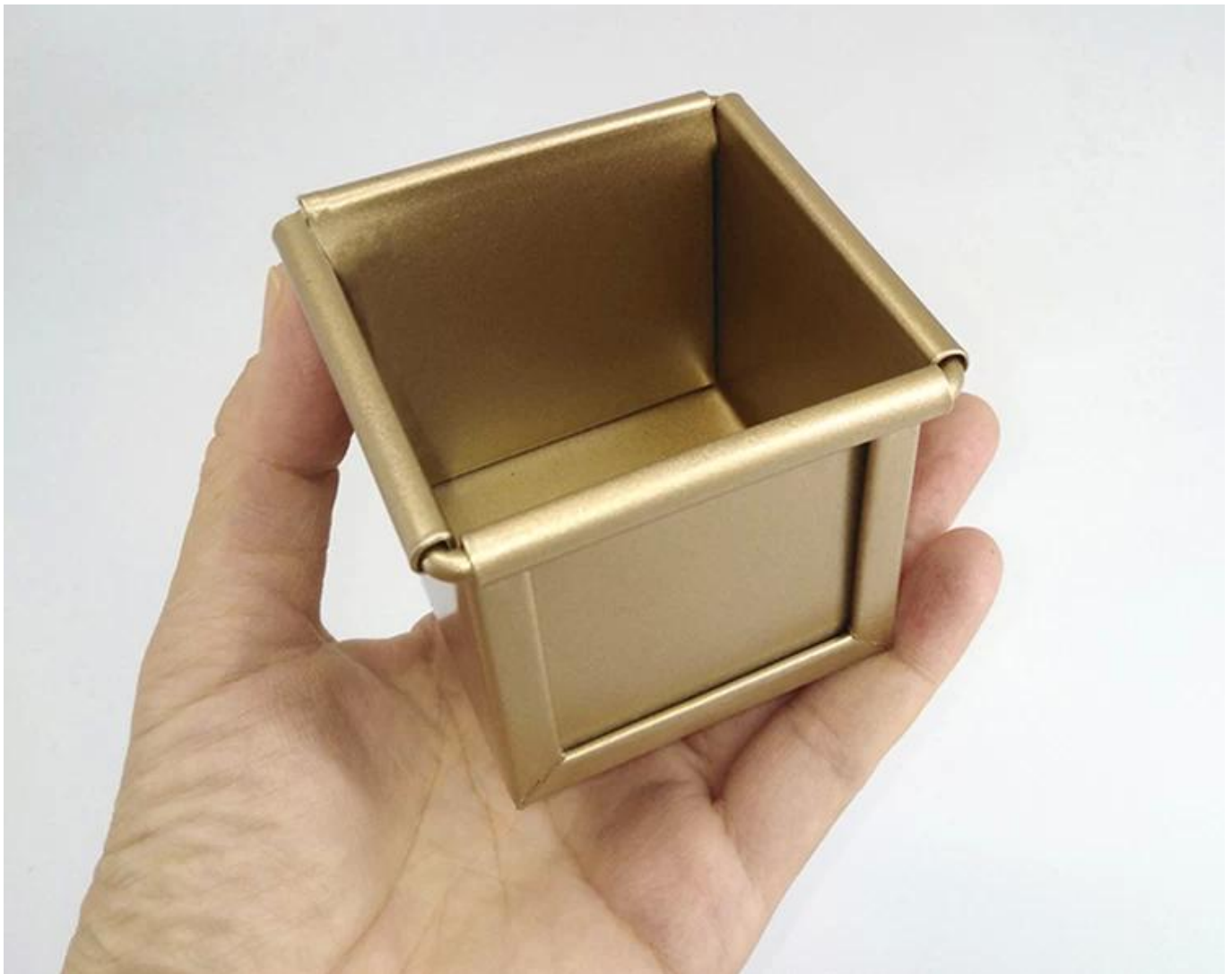











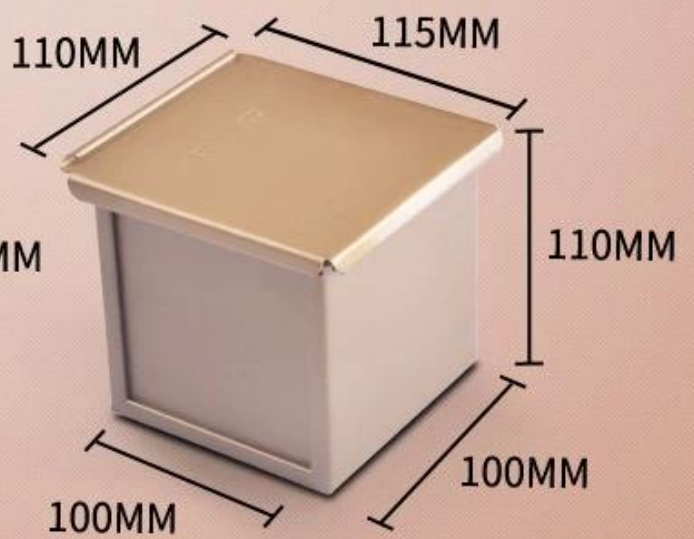
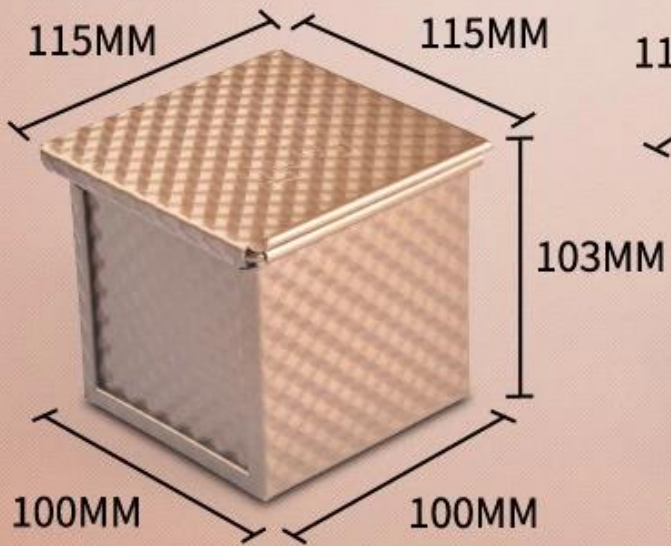
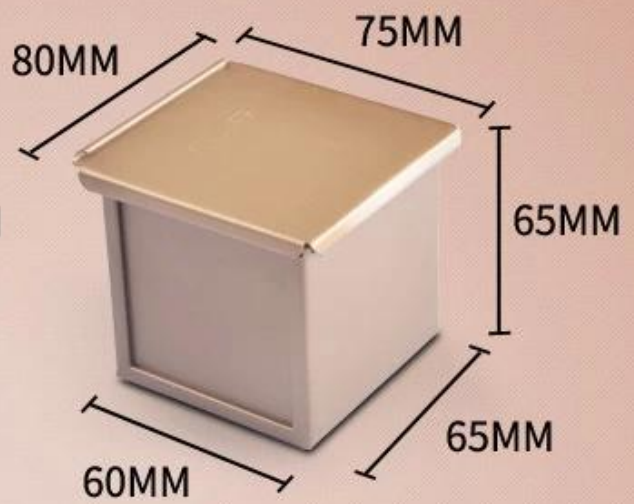
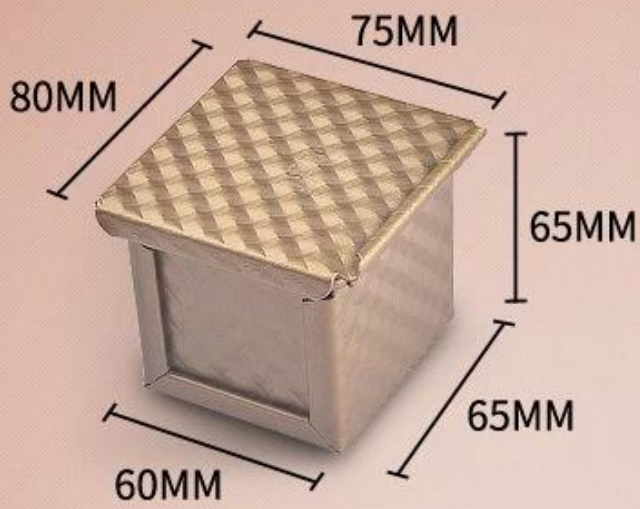



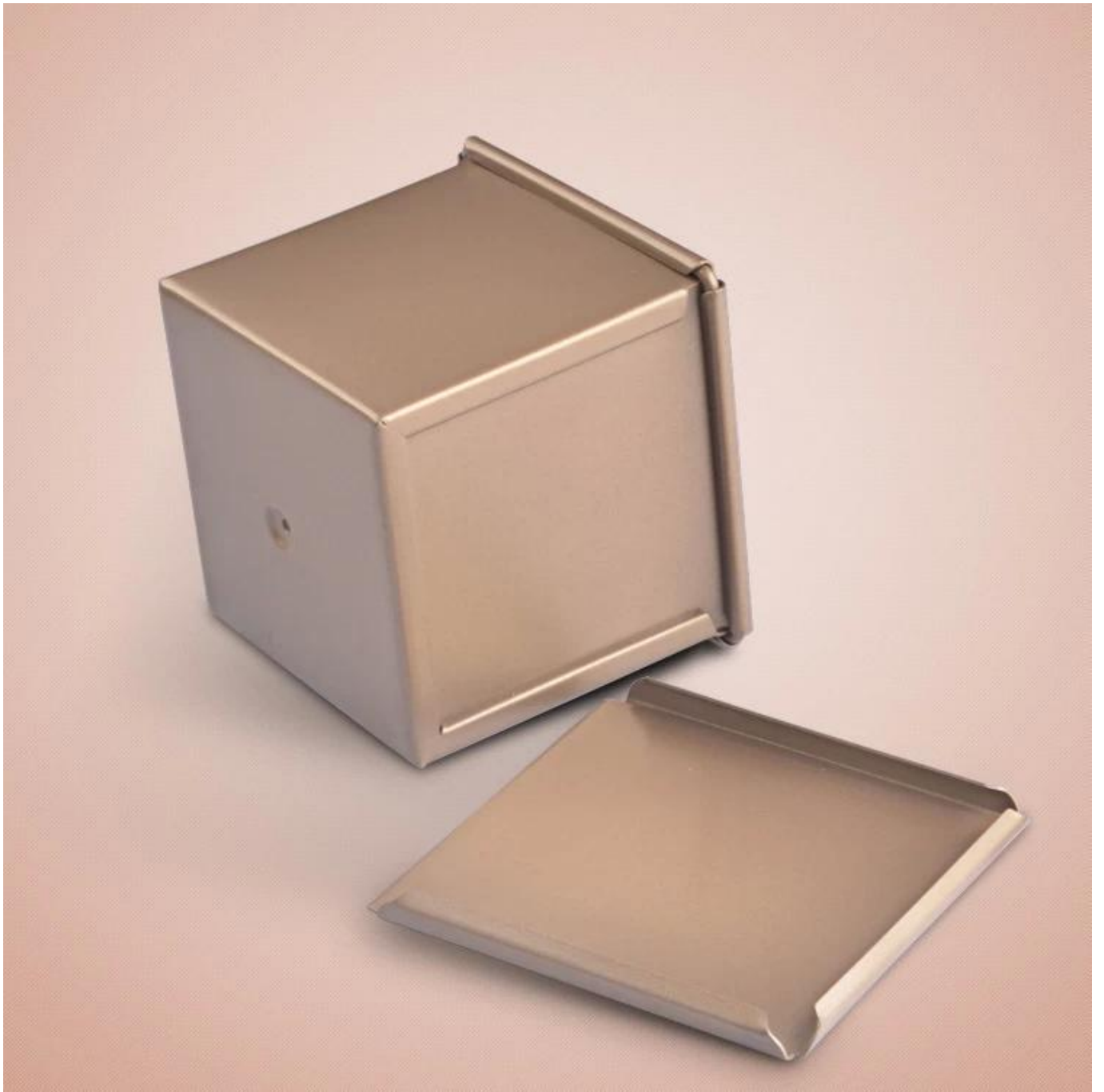

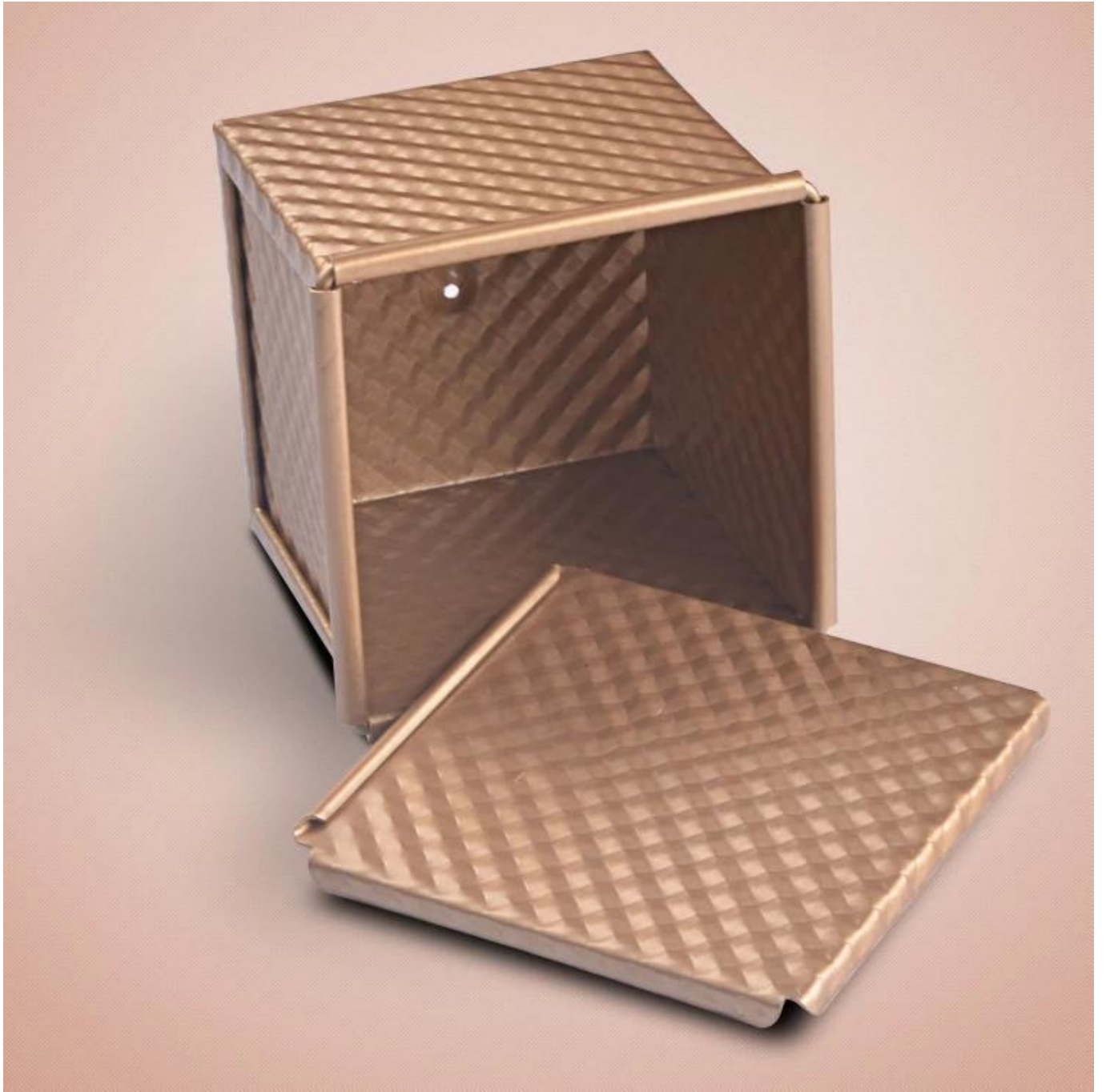

More types of [mini loaf pans with lids](#) from Tsingbuy



More bread loaf pan toast baking box with lid from Tsingbuy

customized single loaf pan



Teflon coating

Silicone coating



Material:

Aluminum alloy

Aluminized steel



More Customized Strap Loaf Pans from Tsingbuy



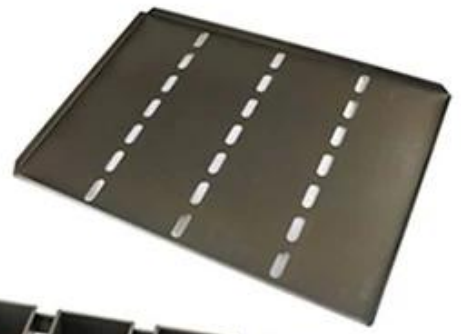



Customized shape
Customized size
Rack matched

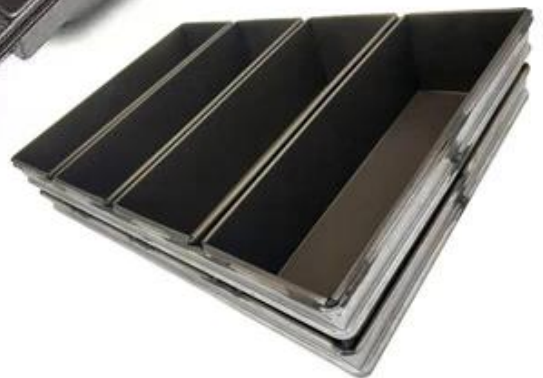

Customized Single Loaf Pan

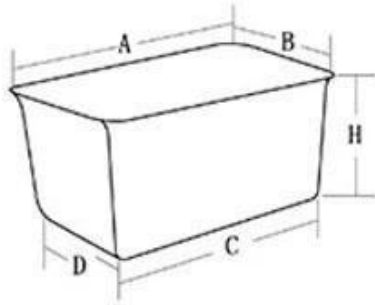

- A.Top length of the item
- B.Top width of the item
- C.Bottom length of the item
- D.Bottom width of the item
- H.Height

Customized Strapped Loaf Pan Sets

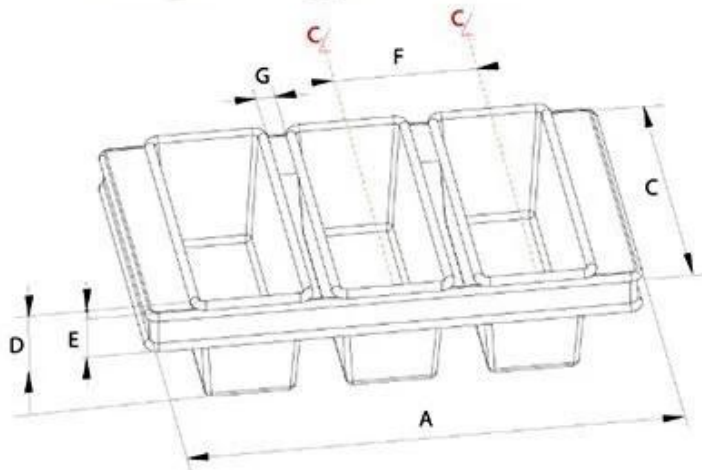

- A.Overall Length
- C.Overall Width
- D.Depth
- E.Frame Height
- F.Center-to-center
- G.Pan Distance



Flat handle



Frame handle



no handle



Matching lid (Drop Style)

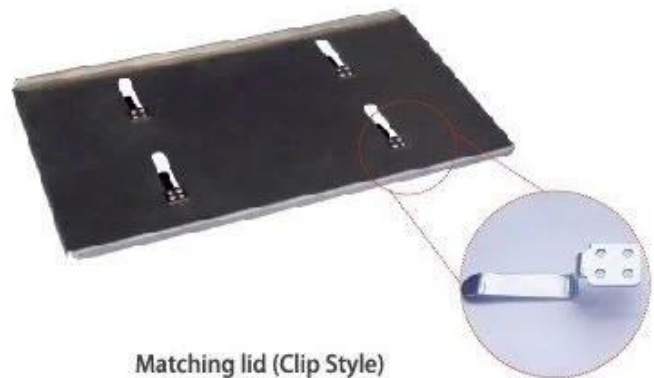

Matching lid (Clip Style)



Loaf Pan

Tsingbuy Industry Limited

