

Bread Loaf Pan Toast Baking Mold Aluminium alusteel Pan with Cover

Main features of Alusteel corrugated bread loaf pan with lid

1. Made of 1.0mm thick aluminum alloy, durable for long service life.
2. Food-safe and corrugated, corrugated surface not sticky, easy to demould, easy to clean
3. The bottom hole is optional for better circulation of hot air and uniform heating.
4. Wire in rim design makes it more durable and not easy to deformation for long service life.
5. Multiple function for making sandwiches, toast, traditional loaf breads etc.
6. ODM & OEM is available in Tsingbuy professional **pullman loaf pan manufacturer**.
7. Tsingbuy [bread loaf pan manufacturer](#) has been providing custom bakeware for international market for over 12 years.

Product images of corrugated alusteel bread baking pan with cover

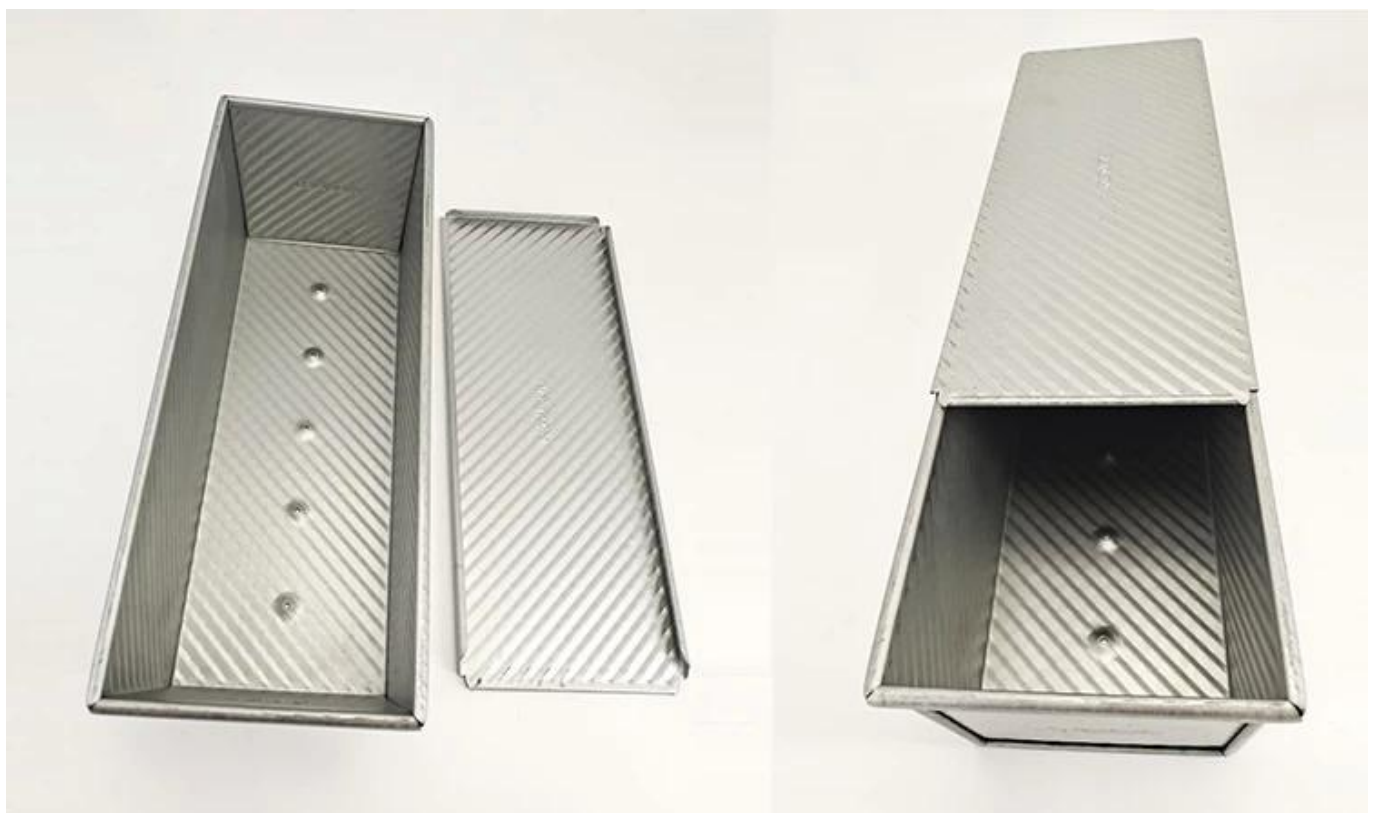





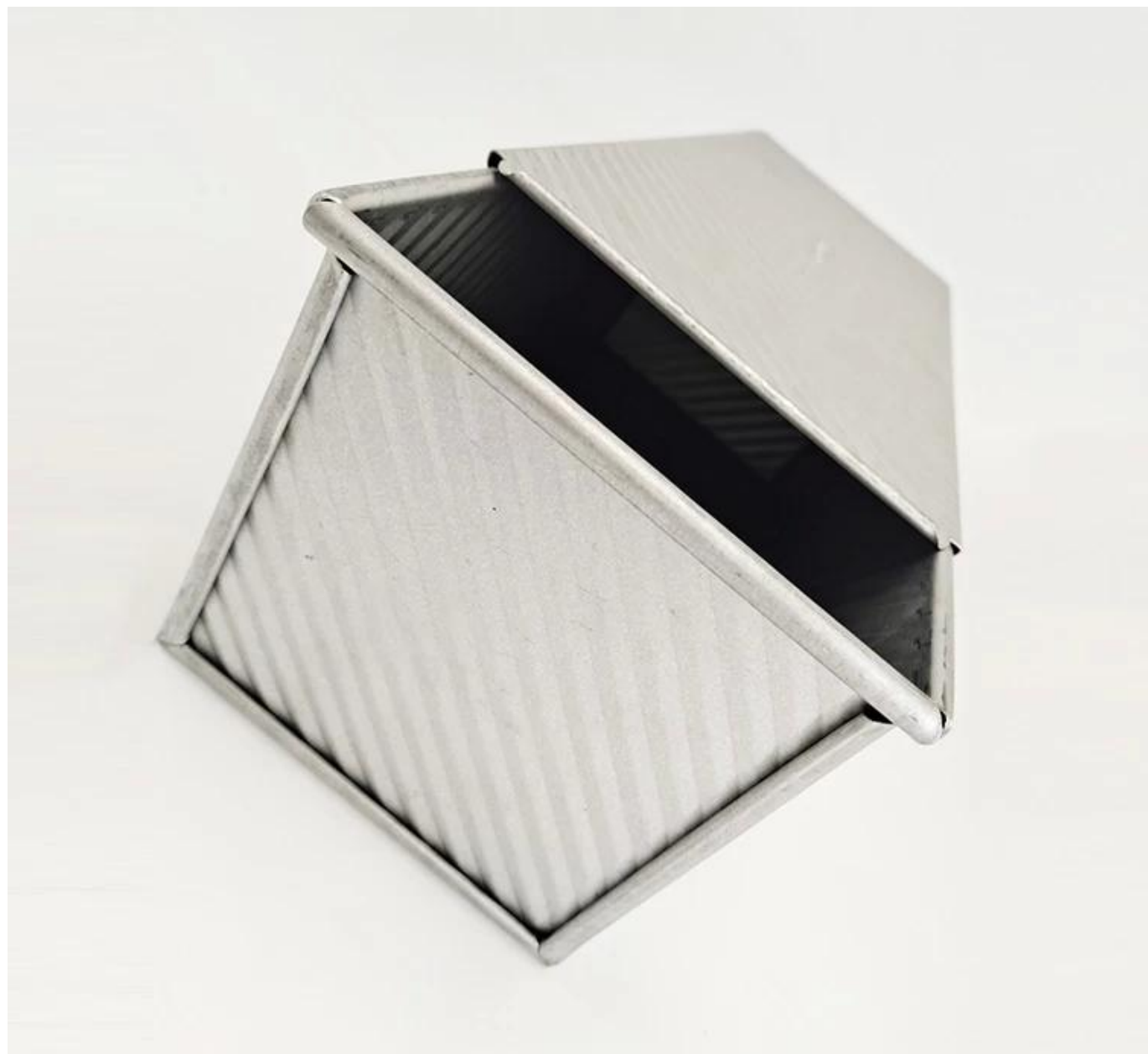



More types of aluminium pans & bread loaf pans for your information

Here are more types for your information from Tsingbuy [aluminium pans factory](#)

Our Pullman loaf pans is designed with simple style, beautiful and practical with fast heat conduction, even heating, not easy to appear partial scorch.

Material optional: aluminum, aluminized steel, stainless steel

Perforation options: no perforation, bottom-perforated, all-perforated

Using scene: single loaf pan, strap loaf pan

Surface options: smooth, corrugated, no-coating, Teflon non-stick, silicone non-stick

Size: any size

Lid: with lid or not as your requirement.

customized single loaf pan



Teflon coating

Silicone coating



Material:

Aluminum alloy

Aluminized steel

Custom manufacturing of strap loaf pan is one of our biggest strength, welcome for more info. We have engaged in bakeware manufacturing for over 12 years and has been supplying thousands of bakeware for international customers. Using our baking pan, you can easily make all kinds of delicious food, Chiffon cakes, mousse cake, Pound cake, cheese cake, etc

More Customized Strap Loaf Pans from Tsingbuy



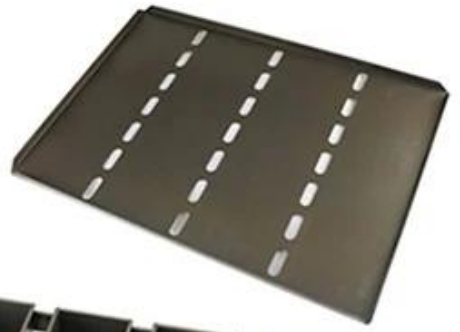

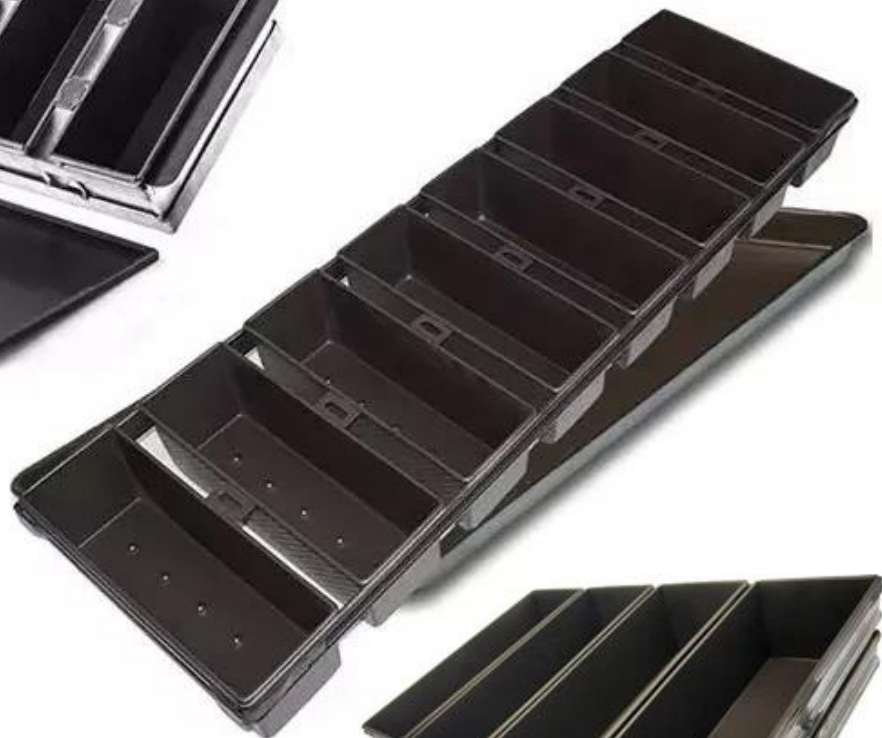

Customized shape
Customized size
Rack matched

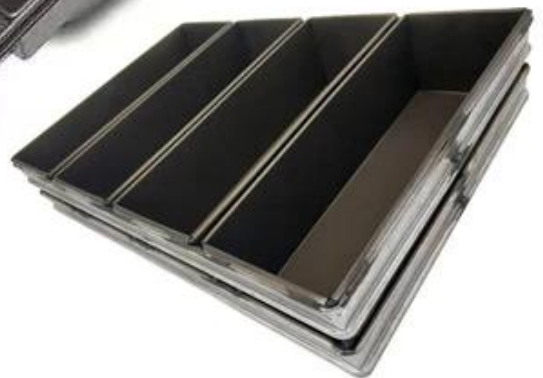

Customized Single Loaf Pan

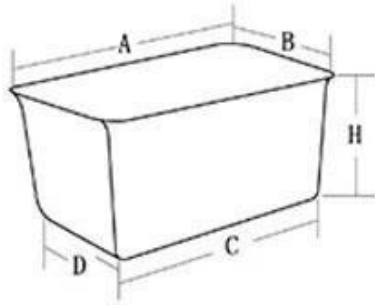

- A.Top length of the item
- B.Top width of the item
- C.Bottom length of the item
- D.Bottom width of the item
- H.Height

Customized Strapped Loaf Pan Sets

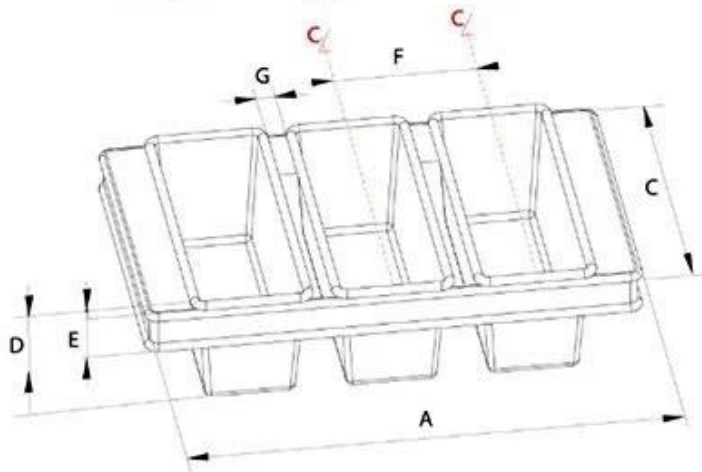

- A.Overall Length
- C.Overall Width
- D.Depth
- E.Frame Height
- F.Center-to-center
- G.Pan Distance



Flat handle



Frame handle



no handle



Matching lid (Drop Style)

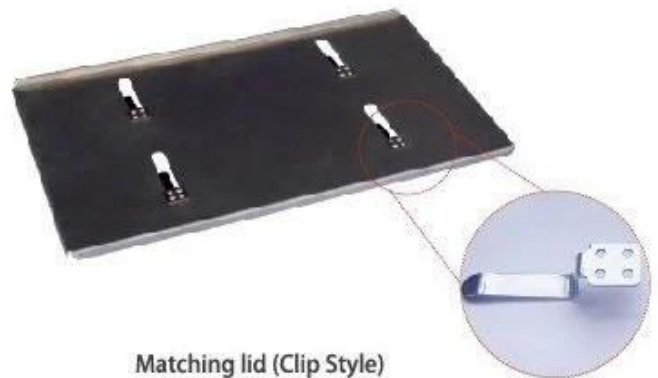

Matching lid (Clip Style)

Factory pictures



Loaf Pan

Tsingbuy Industry Limited



Welcome to visit us Tsingbuy commercial and industrial [strap loaf pan with lid supplier](#).

