

One-piece Material Molded Aluminum Non Stick Pullman Bread Loaf Tin Toast Bread Baking Pan with Lid for Home Kitchen and Commercial Bakery Restaurant Use

Main features of one-piece molded aluminum non stick pullman bread loaf tin toast bread baking pan with lid

1. **Durable Aluminum Material:** Crafted with high-quality aluminum, this loaf bread pan ensures excellent heat conduction and distribution, resulting in evenly baked goods. With a thickness of 1.0mm, it guarantees sturdiness and longevity, making it a reliable addition to your kitchen arsenal.
2. **Thoughtful Construction:** Designed with convenience in mind, our loaf bread pan features a one-piece sheet material molding. This eliminates the risk of any seams or joints that may cause leaks or uneven baking. Additionally, the pan is equipped with holes at the bottom, allowing excess moisture to escape and promoting optimal airflow. The included lid provides an airtight seal, preserving freshness and enhancing flavor.
3. **Double-sided Non-Stick Coating:** Say goodbye to the struggle of removing your baked creations from the pan! Our loaf bread pan boasts a double-sided non-stick coating, preventing your bread or cake from sticking to the surface. This feature makes it effortless to release your delectable creations, leaving you with perfectly shaped loaves every time and simplifying the cleaning process.
4. **Versatile Capacity and Functions:** With a generous 450g capacity, this loaf bread pan caters to your various baking needs. Whether you're baking traditional bread loaves, flavorful cakes, or even experimenting with other recipes, this pan has got you covered. Its multi-functionality allows you to explore a wide range of culinary delights, making it an indispensable tool in your kitchen.
5. **Professional ODM&OEM Service:** Tsingbuy [pullman loaf tin factory](#) has been offering professional ODM and OEM services with over 15 years experience. This means that not only can you enjoy the superior quality of our loaf bread pan, but we also provide an opportunity for home kitchen bakers and bakeware wholesalers to elevate their business. Customize this pan with your branding or design, and take advantage of our expertise to create a unique product that reflects your vision.

Product images of one-piece molded aluminum non stick pullman bread loaf tin toast bread baking pan with lid

One Piece Integrated Molding Bread Loaf Pan with Lid



Integrated Molding Aluminum Non Stick Bread Loaf Pan with Lid



Holes at Bottom for Ventilation



ABLE AND EASY TO DEM

Enjoy Your DIY with Family



Curled Edges for Four Sides
Easy to Sliding-on-off cover

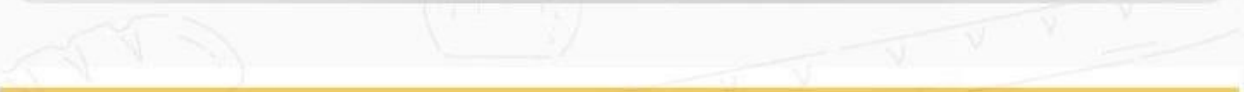



Double-side Non Stick Coated Bread Loaf Pan with Lid





450g dough

baking pan weight: 309g

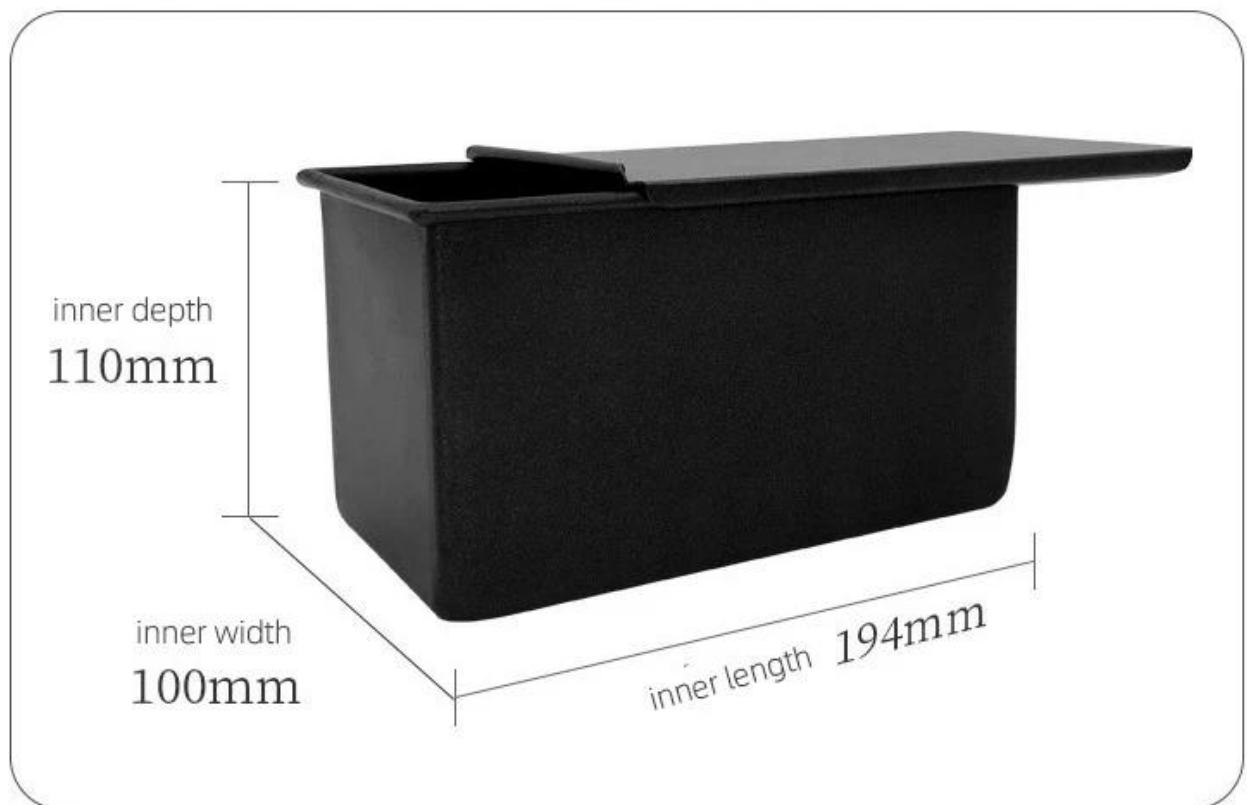



More types of bread & loaf pans for your information

Here are more designs for bread loaf pans.

Our Pullman loaf pans is designed with simple style, beautiful and practical with fast heat conduction, even heating, not easy to appear partial scorch.

Material optional: aluminum, aluminized steel, stainless steel

Perforation options: no perforation, bottom-perforated, all-perforated

Using scene: single loaf pan, strap loaf pan

Surface options: smooth, corrugated, no-coating, Teflon non-stick, silicone non-stick

Size: any size

Lid: with lid or not as your requirement.

customized single loaf pan





Besides [wholesale aluminum loaf pans](#) in single box, ODM&OEM service of sheet pan, baguette pan, multi-mould cupcake pan, strap loaf pan is also one of our biggest strength, welcome for more info.

We have engaged in bakeware manufacturing for over 12 years and has been supplying thousands of bakeware for international customers. Using our baking pan, you can easily make all kinds of delicious food, Chiffon cakes, mousse cake, Pound cake, cheese cake, etc

More Customized Strap Loaf Pans from Tsingbuy



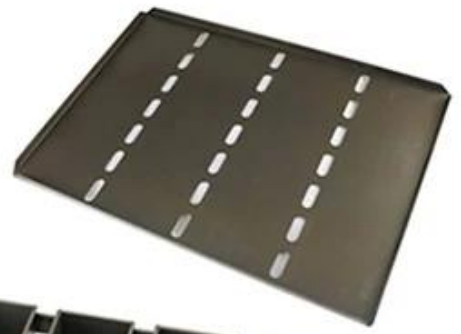

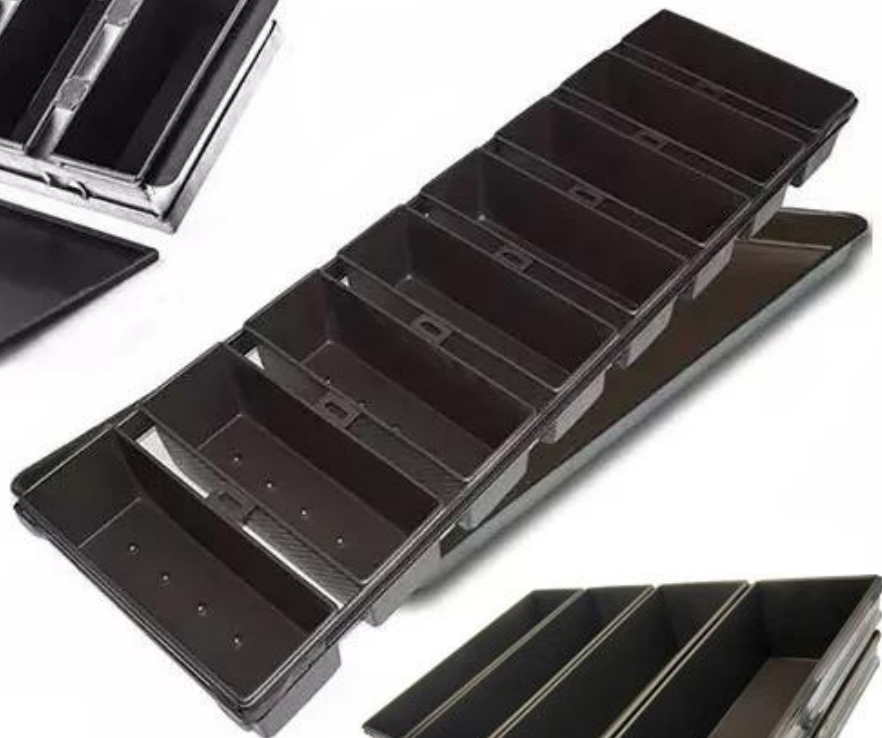

Customized shape
Customized size
Rack matched

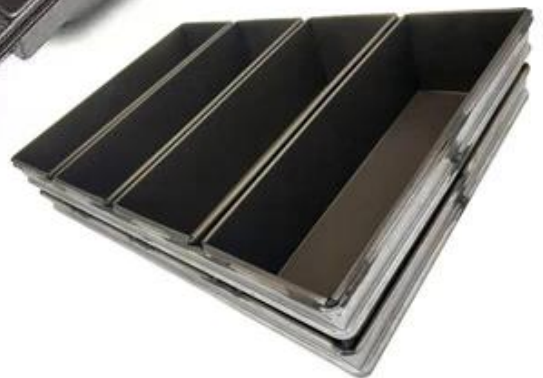

Customized Single Loaf Pan

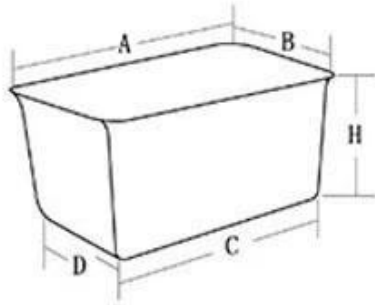

- A. Top length of the item
- B. Top width of the item
- C. Bottom length of the item
- D. Bottom width of the item
- H. Height

Customized Strapped Loaf Pan Sets

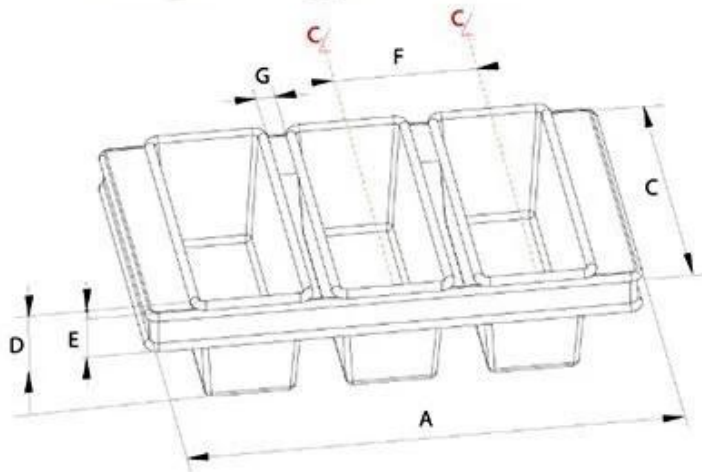

- A. Overall Length
- C. Overall Width
- D. Depth
- E. Frame Height
- F. Center-to-center
- G. Pan Distance



Flat handle



Frame handle

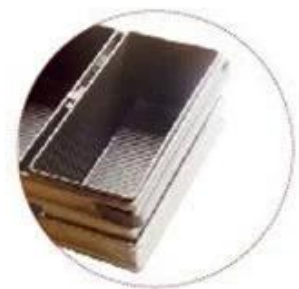

no handle

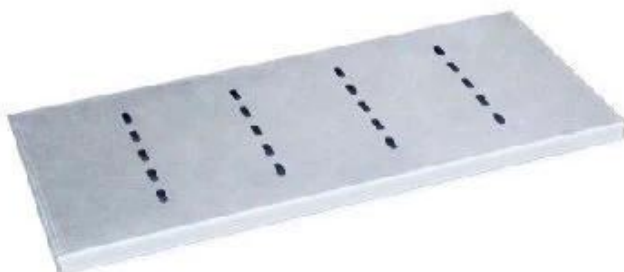

Matching lid (Drop Style)

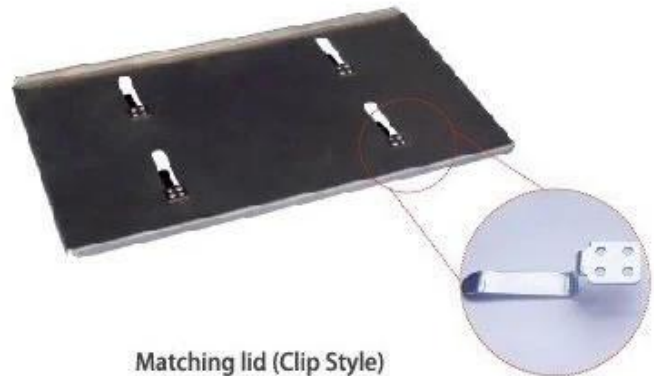

Matching lid (Clip Style)

Factory pictures

Besides loaf bread pans, Tsingbuy [bread tin supplier](#) also produces sheet pan, loaf pan, baguette pan, cupcake baking pan, cake pan etc for bakeries, food factories, restaurants for commercial use. ODM&OEM service is our greatest strength. Welcome to contact us if you are looking for commercial baking pans.



Loaf Pan

Tsingbuy Industry Limited



