

# 304 Stainless Steel Heart Shaped Mousse Ring Cake Ring Molds for Baking

## **Main features of heart shaped stainless steel mousse ring cake ring molds**

High quality 304 stainless steel

Tsingbuy [mousse ring factory](#) applies high-quality stainless steel material, which can directly contact with food, safe to use, with high strength, not easy to deform, not easy to rust, and excellent corrosion-resistant.

Roll edge design

Special curling edge design both upper and lower side, no scraping, easy to take and place

Perforation on stainless steel is optional

Perforated surface is good for uniform heating and fast for heat dissipation. You can choose whether be perforated according to your requirements.

Various shapes and multiple sizes for options

Round, oval, square, rectangle, heart, hexagon and many other shapes are optional, freely creating gourmet art works.

## **Pictures of heart shaped stainless steel mousse ring cake ring molds**





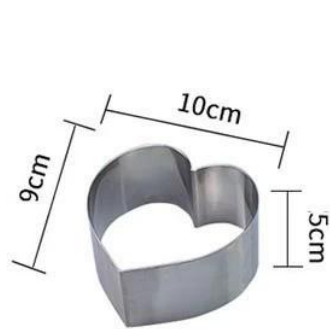

4 inch



5 inch

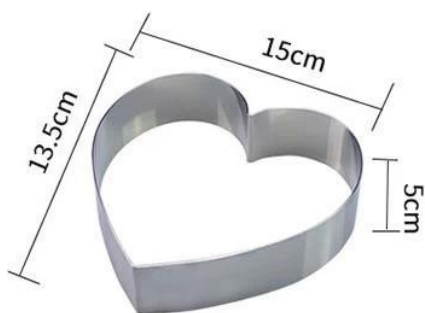

6 inch



7 inch

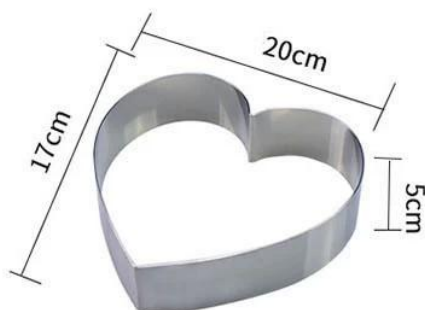

8 inch

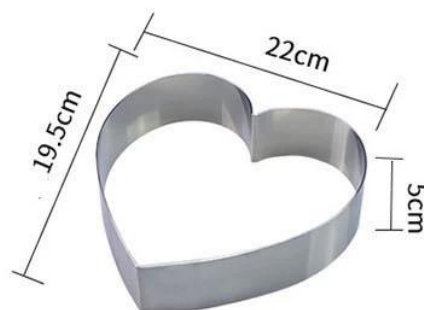

9 inch

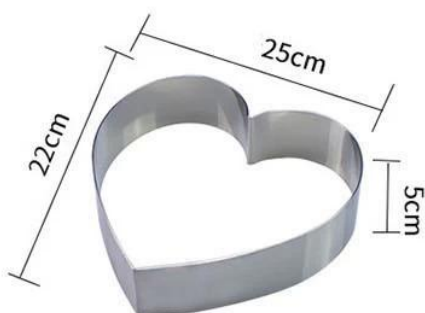

10 inch







### **Other cake baking molds that you might be interested**

Here are more cake baking molds from Tsingbuy [cake molds manufacturer](#). Whether you are looking for a regular baking cake mold, or seeking for custom made cake mold, welcome to come to us.



**Non-stick Coated Cake Pans**



**Anodized Surface**



**Custom Size**



**Custom Design**







**non-stick coated**

**Fixed bottom  
Square  
Rectangular**



**anodized surface**



**Detachable / removable bottom**





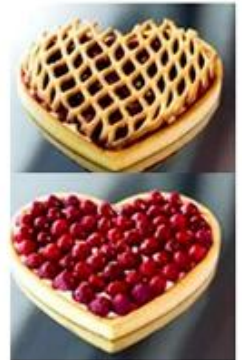

## Factory Show

Besides [wholesale heart cake molds](#), Tsingbuy bakeware manufacturer also provides aluminum cake pans, aluminum trays, aluminum baguette baking pan, bread loaf pan, multi-mould cupcake baking pans etc, as well as ODM&OEM service of bakery supplies. Welcom to contact us at any time.

## Production Machines



Automatic cutting machine



Automatic punching machine



Punching machine



Bending machine



Sand blasting machine

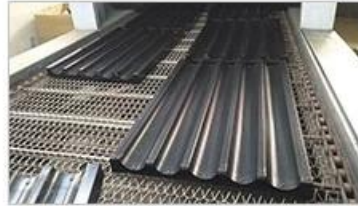

Drying machine

## Our Advantages



Professional machine



Standard production flow



Experienced workers



Clean & tidy warehouse



Quick production fast dispatch

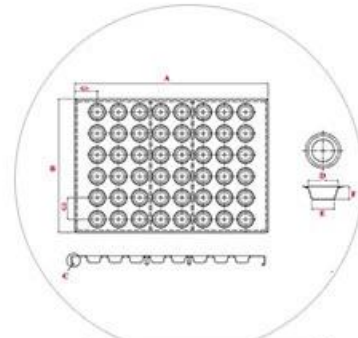

ODM & OEM service

