

# Factory ODM&OEM Bakeware, Aluminum Metal Non Stick Fluted Pullman Bread Loaf Pan Toast Sandwich Bread Baking Tin Mold with Lid

## **Main features of double sided teflon non stick fluted loaf bread baking pan with lid**

1. **Premium Aluminum Material:** Crafted from high-quality aluminum, our loaf bread baking pan is designed to provide even heat distribution, ensuring that your bread bakes to perfection every time.
2. **Double-Sided Teflon Non-Stick Coating with Corrugated Surface:** Say goodbye to sticking and tearing with our double-sided Teflon non-stick coating. The corrugated surface (fluted surface) not only prevents your bread from sticking but also imparts an attractive texture to your loaves, making them a feast for the eyes as well as the taste buds.
3. **Multiple Standard Sizes and Custom Options:** Whether you're a professional baker or a home enthusiast, we've got you covered. Choose from our range of standard sizes, or opt for a custom size to suit your specific requirements. We believe in flexibility to meet your unique needs.
4. **Commercial-Grade Durability:** Built to endure the rigors of a bakery, restaurant, or food factory, our bread loaf baking pan is commercial-grade and can withstand heavy usage. However, it's not just for the pros - it's also the best quality choice for your home kitchen, ensuring your homemade bread turns out as good as any bakery.
5. **Proudly Crafted by Professionals in China:** Tsingbuy is a [commercial pullman loaf pan manufacturer](#) based in China with over 15 years experience and trusted by loyal customers from 180+ countries. Our Loaf Pan is a cornerstone product in our range. When you choose our pan, you're not just choosing a product; you're choosing a partner in baking success. Count on us to help you excel in your local market and elevate your baking game.

## **Product images of double sided teflon non stick fluted loaf bread baking pan with lid**



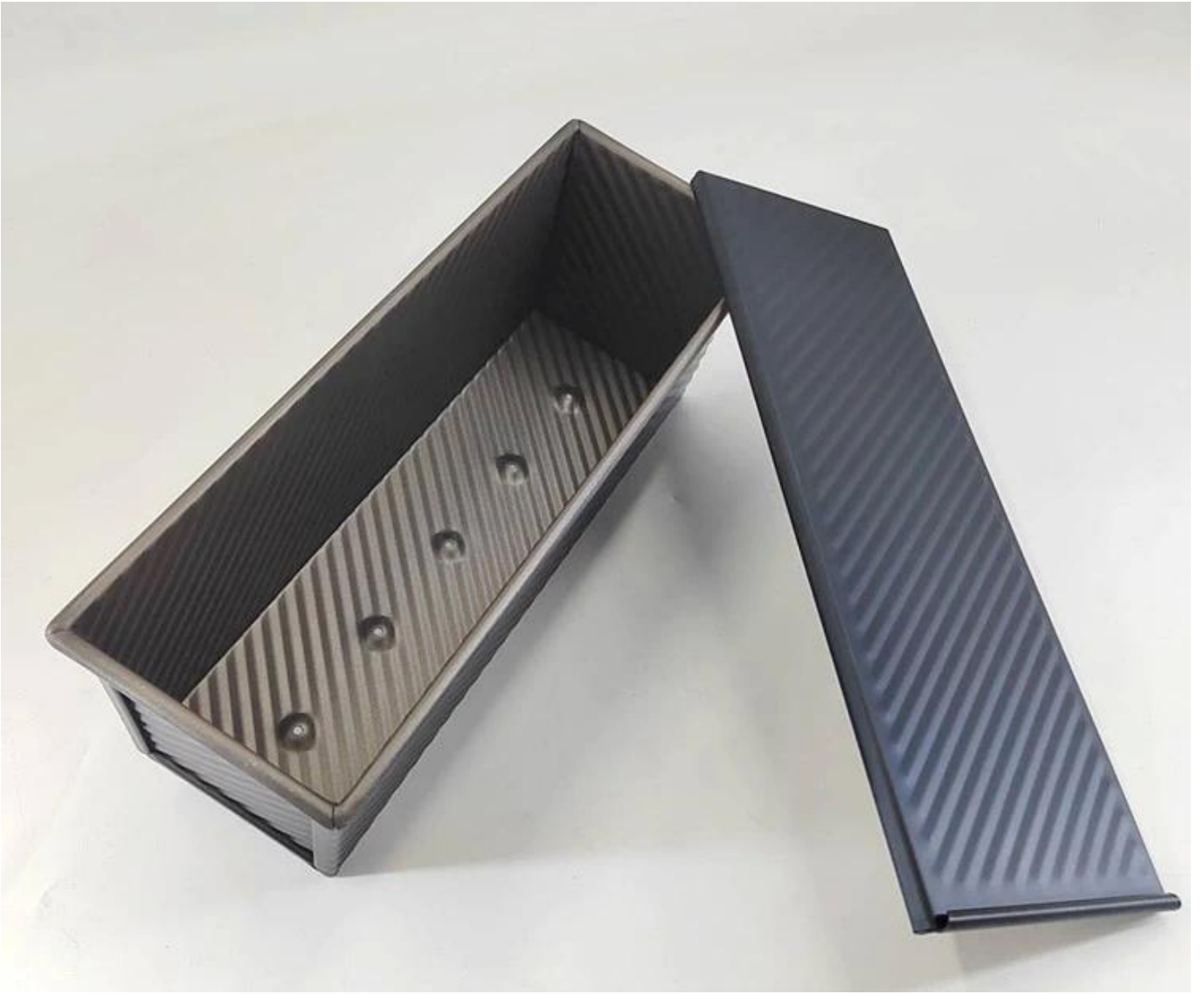







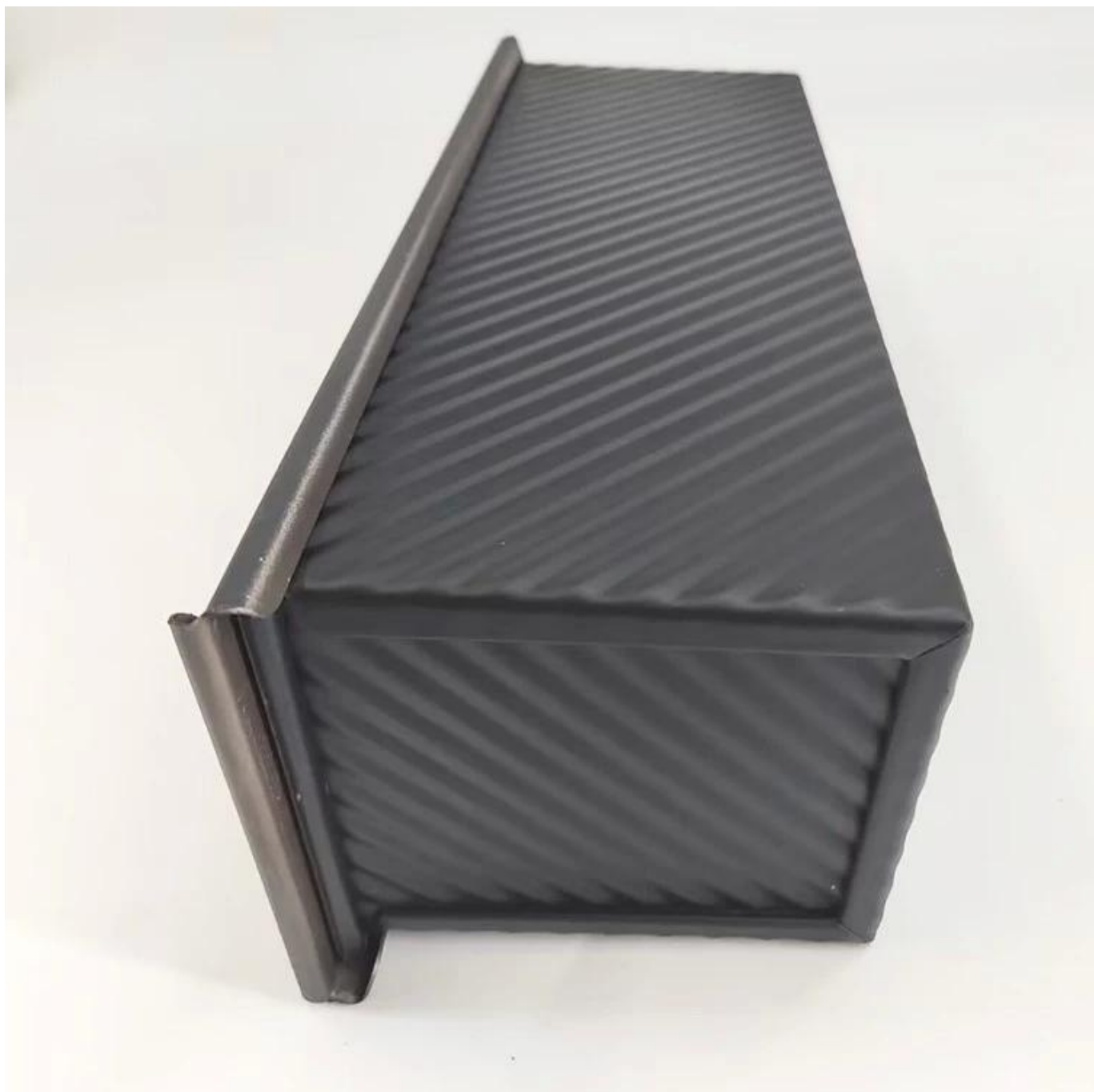





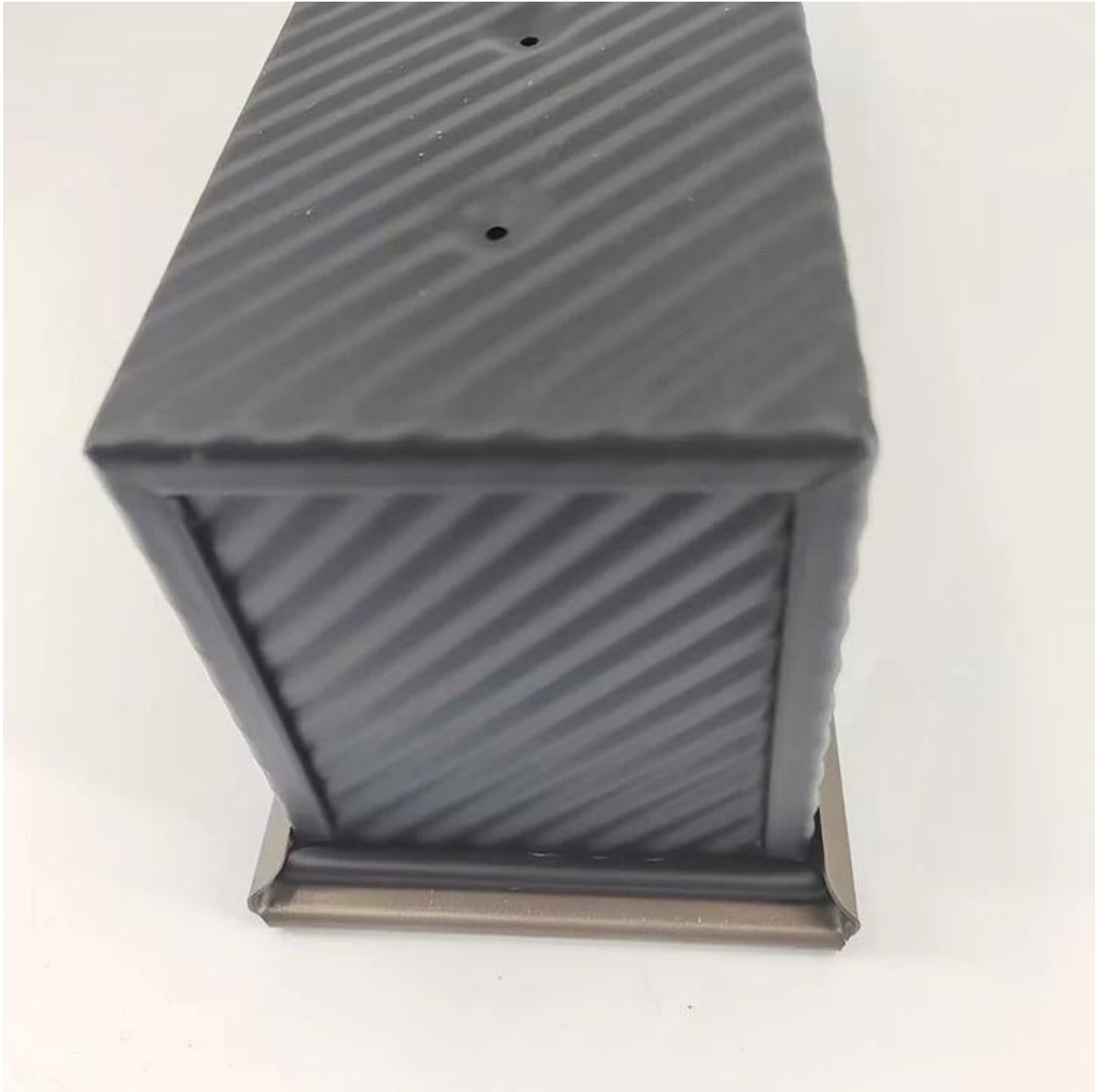

### **More types of bread & loaf pans for your information**

Here are more [wholesale aluminum loaf pans](#) for both bakery and home kitchen use.

Our pullman loaf pans is designed with simple style, beautiful and practical with fast heat conduction, even heating, not easy to appear partial scorch.

Material optional: aluminum, aluminized steel, stainless steel

Perforation options: no perforation, bottom-perforated, all-perforated

Using scene: single loaf pan, strap loaf pan

Surface options: smooth, corrugated, no-coating, Teflon non-stick, silicone non-stick

Size: any size

Lid: with lid or not as your requirement.

# customized single loaf pan





Teflon coating



Silicone coating



Material:

Aluminum alloy

Aluminized steel



Custom manufacturing of strap loaf pan is one of our biggest strength, welcome for more info.

Tsingbuy [non stick loaf pan supplier](#) has been engaged in bakeware manufacturing for over 12 years and has been supplying thousands of bakeware for international customers. Using our baking pan, you can easily make all kinds of delicious food, Chiffon cakes, mousse cake, Pound cake, cheese cake, etc

## More Customized Strap Loaf Pans from Tsingbuy







Customized shape  
Customized size  
Rack matched

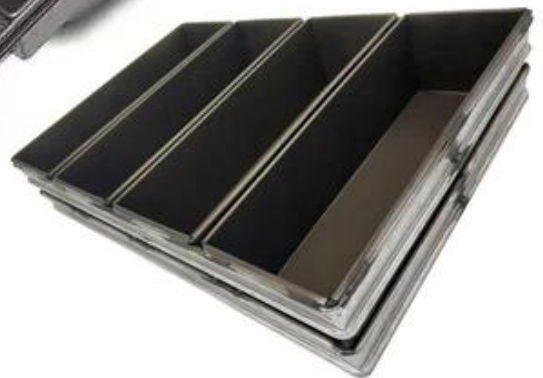

## Customized Single Loaf Pan

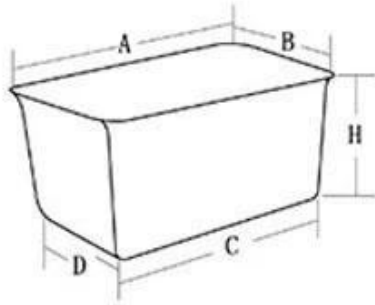

- A. Top length of the item
- B. Top width of the item
- C. Bottom length of the item
- D. Bottom width of the item
- H. Height

## Customized Strapped Loaf Pan Sets

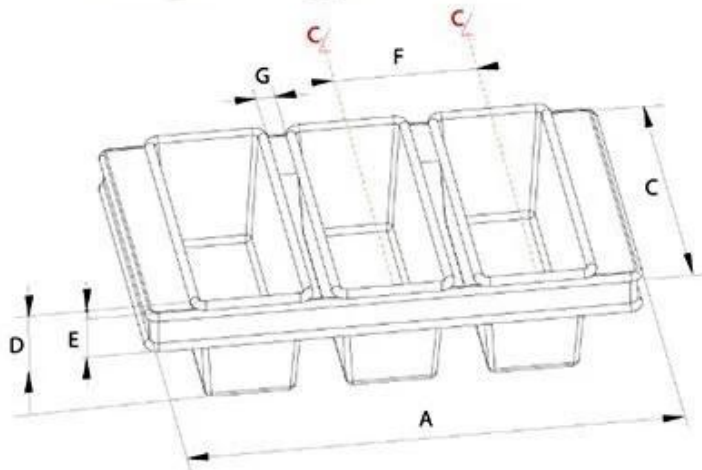

- A. Overall Length
- C. Overall Width
- D. Depth
- E. Frame Height
- F. Center-to-center
- G. Pan Distance



Flat handle



Frame handle

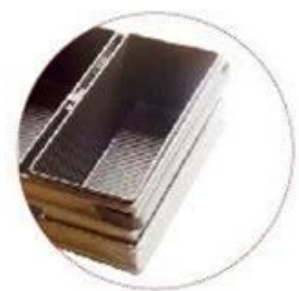

no handle

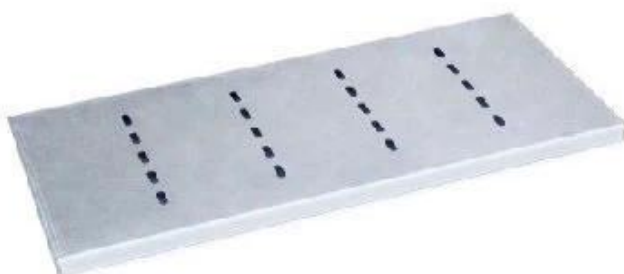

Matching lid (Drop Style)

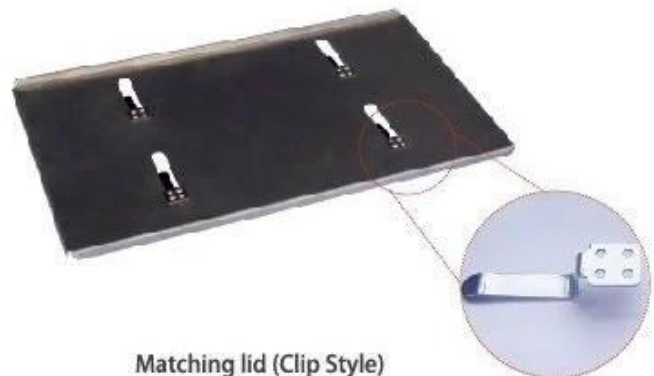

Matching lid (Clip Style)

Tsingbuy loaf & bread pan factory pictures

## Pictures of Workshop













