

Custom Made Industrial Use Aluminized Steel Non Stick 10-Cavities Strap Loaf Pan Toast Sandwich Bread Baking Tin Mold Set

Main features of custom made aluminized steel 10-cavities non stick strap loaf bread baking pan set

1. This commercial bread baking pan is capable of holding (10) loaves, each box with 165x80mm size. This product allows you to produce ten loaves to sell or serve quickly while still maintaining the quality of baking. Whether you need to make your signature dinner loaves or seasonal breads, this bread pan is a good choice to help you finish your baking job easily.
2. The bread loaf pans are manufactured from 0.7/1.0/1.2mm aluminized steel with double folded corners, The edge of each pan is fitted with a 5mm diameter rim wire. The frames are manufactured of 1.2mm aluminized steel for super support and durability. The surface of bread pans are fluted finish and come with steam holes. Not suitable for Gluten-free mixtures.
3. This strap bread loaf pan is manufactured in China [large loaf pans manufacturer](#) - Tsingbuy Industry Limited. It is available in a range of sizes, in various configurations to suit all industrial, commercial or domestic ovens.

Product images of custom made aluminized steel 10-cavities non stick strap loaf bread baking pan set







3 pcs



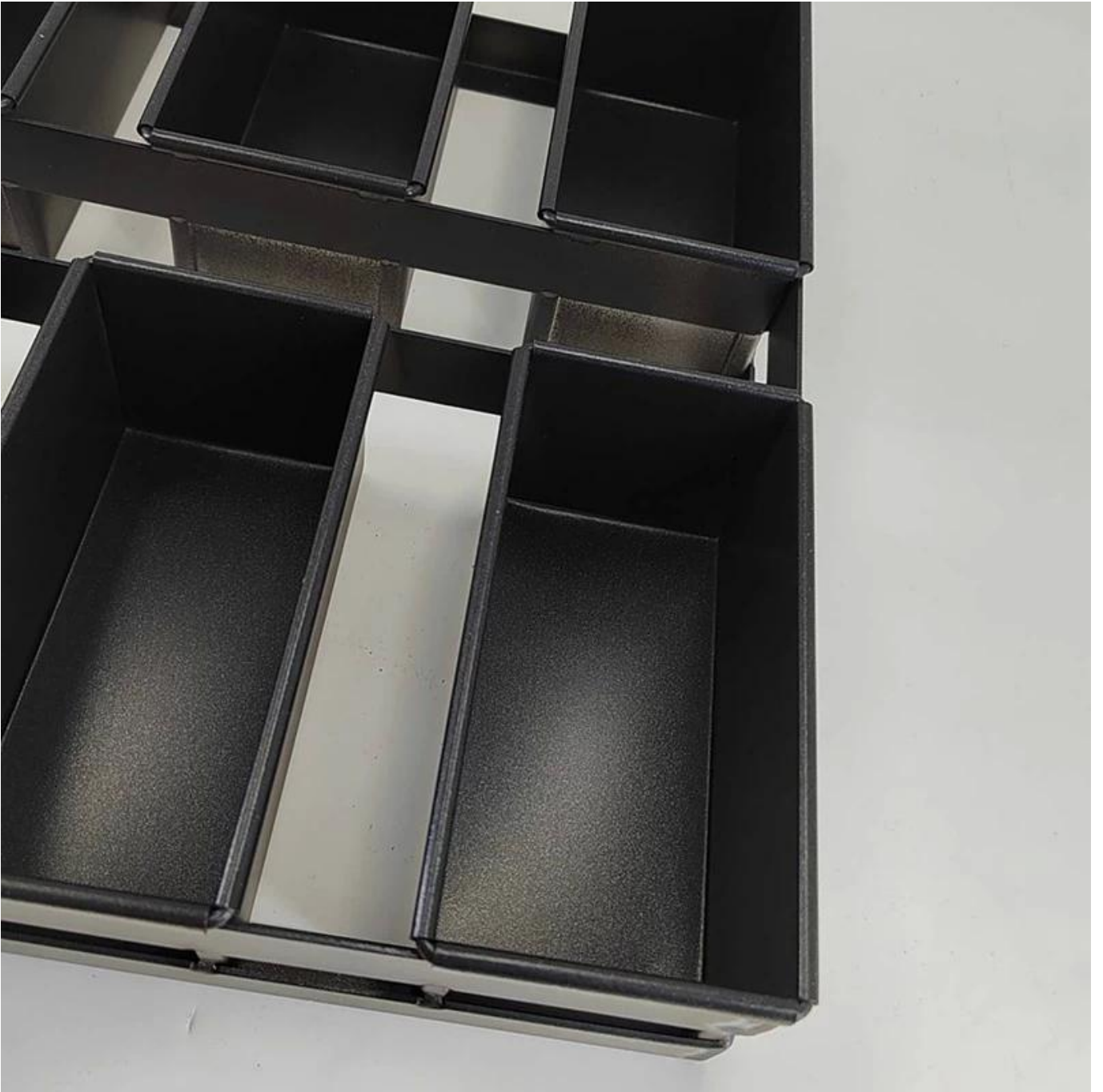



Tsingbuy is professional in making both single loaf pan and strap loaf pans. Here we share some models of strap loaf pan for your reference. Most of the strap loaf pans are custom designed according to requirements.

More Customized Strap Loaf Pans from Tsingbuy



Customized Single Loaf Pan

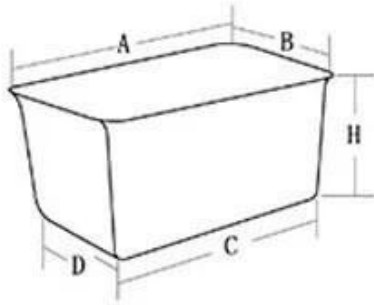

- A. Top length of the item
- B. Top width of the item
- C. Bottom length of the item
- D. Bottom width of the item
- H. Height

Customized Strapped Loaf Pan Sets

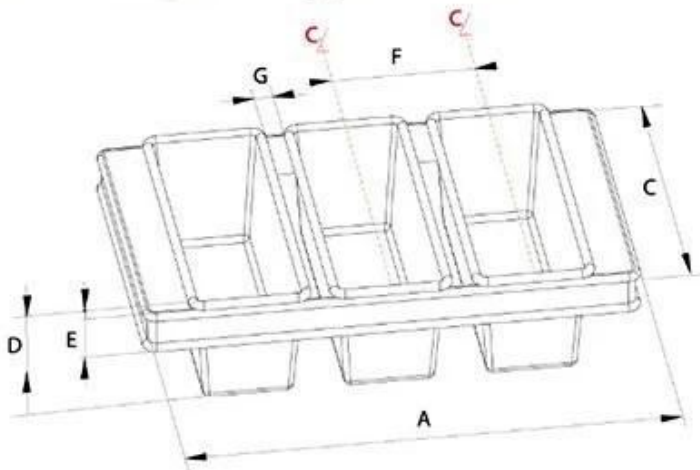

- A. Overall Length
- C. Overall Width
- D. Depth
- E. Frame Height
- F. Center-to-center
- G. Pan Distance



Flat handle



Frame handle



no handle

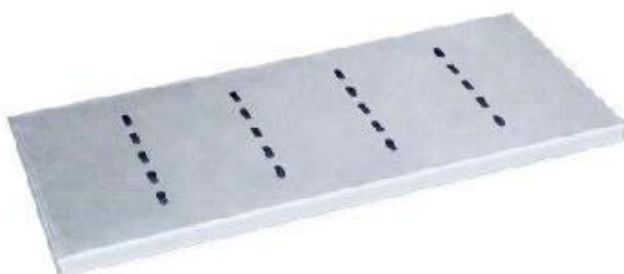

Matching lid (Drop Style)

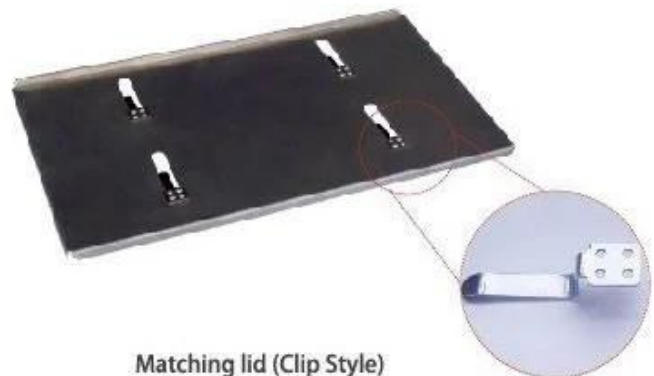

Matching lid (Clip Style)



Customized shape
Customized size
Rack matched

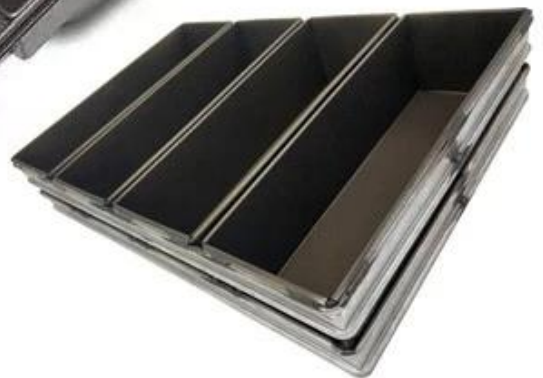

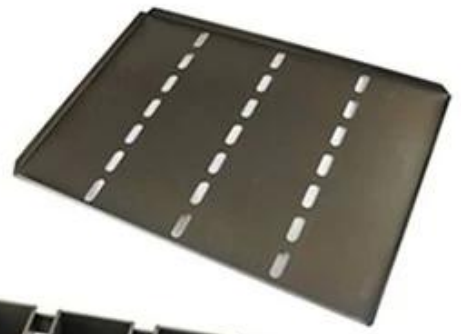

Procedures for custom made loaf baking pans

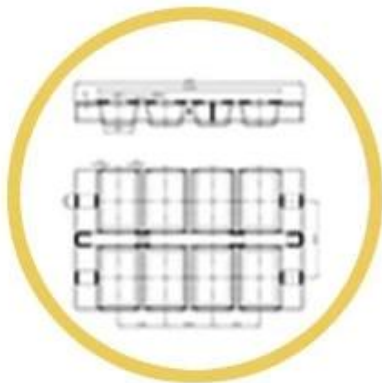

1. DRAWING



2. DESIGN



3. PRODUCT



6. SHIPPING



5. LOADING



4. PACKING



**Custom Made
Strap Loaf Pan
Used with
Bakery Trolley**



More types of single bread loaf baking pan for home kitchen, bakery, restaurant etc

Here are some classic models of single loaf bread baking pan from Tsingbuy [non stick loaf pan supplier](#).

Single Loaf Pan



natural surface



corrugated



full perforation



nonstick



corrugated



golden color



holes at bottom



full perforation



custom size







Besides [bread loaf pan wholesale](#), Tsingbuy bakeware manufacturer also provides custom design and wholesale of other commercial bakeware, such as sheet pans, baguette pans, loaf pans, multi-mould baking pans, bakery trolley, cake pans etc. Welcom to consult us at any time.

