

Wholesale Corrugated Non Stick Aluminum Bread Baking Pan Loaf Toast Bread Baking Tin with Lid

Main features of corrugated non stick aluminum bread baking pan with lid

1. made of 1.0mm thick aluminum alloy, durable for long service life.
2. food-safe non-stick surface is not sticky, easy to demould, easy to clean
3. designed with cover, it is convenient to make American toast with flat sides. The corrugated surface makes it more convenient to demould.
4. The bottom hole is optional for better circulation of hot air and uniform heating.
5. Wire in rim design makes it more durable and not easy to deformation for long service life.
6. Multiple function for making sandwiches, toast, traditional loaf breads etc.
7. ODM & OEM is available in Tsingbuy professional [aluminum bread pan manufacturer](#).
8. Tsingbuy is a professional supplier which has proudly manufactured high quality baking trays, pullman loaf tins and provided custom bakeware for international market for over 12 years.

Product images of corrugated non stick aluminum bread baking pan with lid

320g Non Stick Bread Loaf Pan

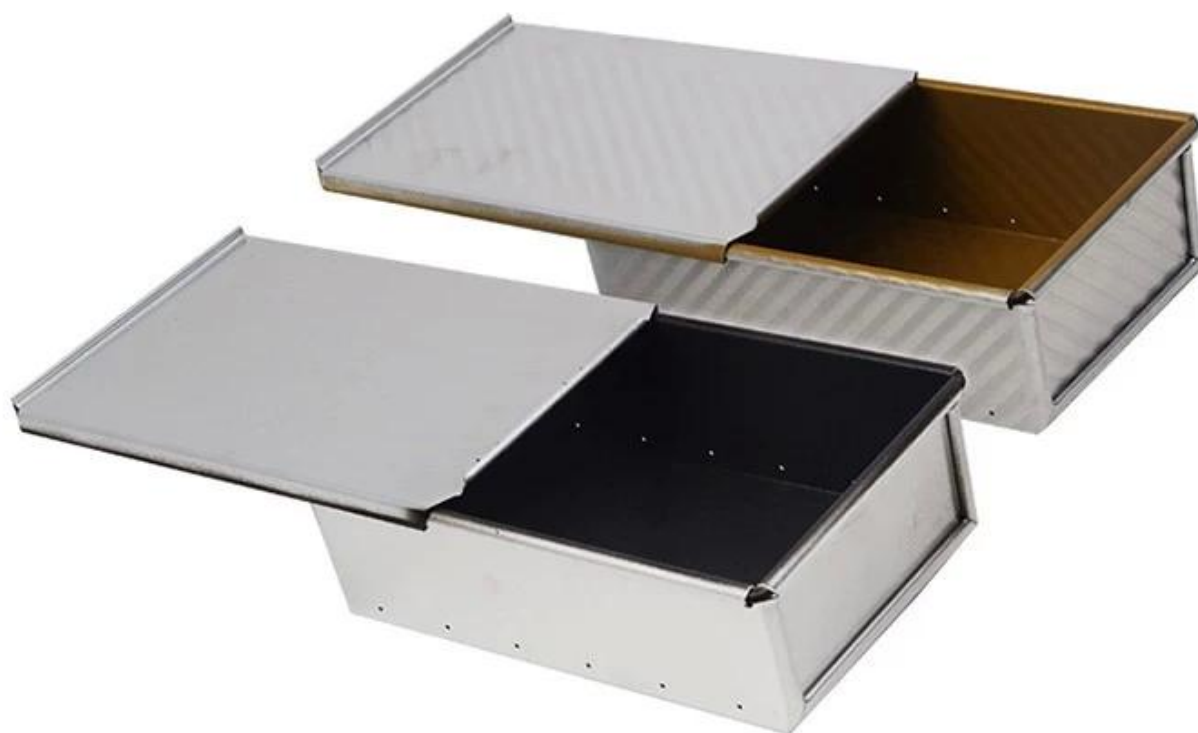

Specifications

up 187x117x60mm
bottom 185x115mm

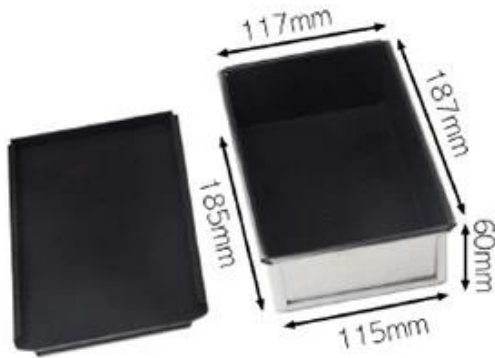

up 187x117x60mm
bottom 185x115mm











More types of bread & loaf pans for your information

Here are more designs for bread loaf pans.

Our Pullman loaf pans is designed with simple style, beautiful and practical with fast heat conduction, even heating, not easy to appear partial scorch.

Material optional: aluminum, aluminized steel, stainless steel

Perforation options: no perforation, bottom-perforated, all-perforated

Using scene: single loaf pan, strap loaf pan

Surface options: smooth, corrugated, no-coating, Teflon non-stick, silicone non-stick

Size: any size

Lid: with lid or not as your requirement.

customized single loaf pan





Besides [non stick bread pan wholesale](#), custom manufacturing of strap loaf pan is also one of our biggest strength, welcome for more info.

We have engaged in bakeware manufacturing for over 12 years and has been supplying thousands of bakeware for international customers. Using our baking pan, you can easily make all kinds of delicious food, Chiffon cakes, mousse cake, Pound cake, cheese cake, etc

More Customized Strap Loaf Pans from Tsingbuy



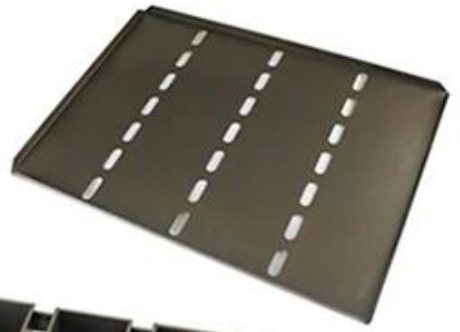

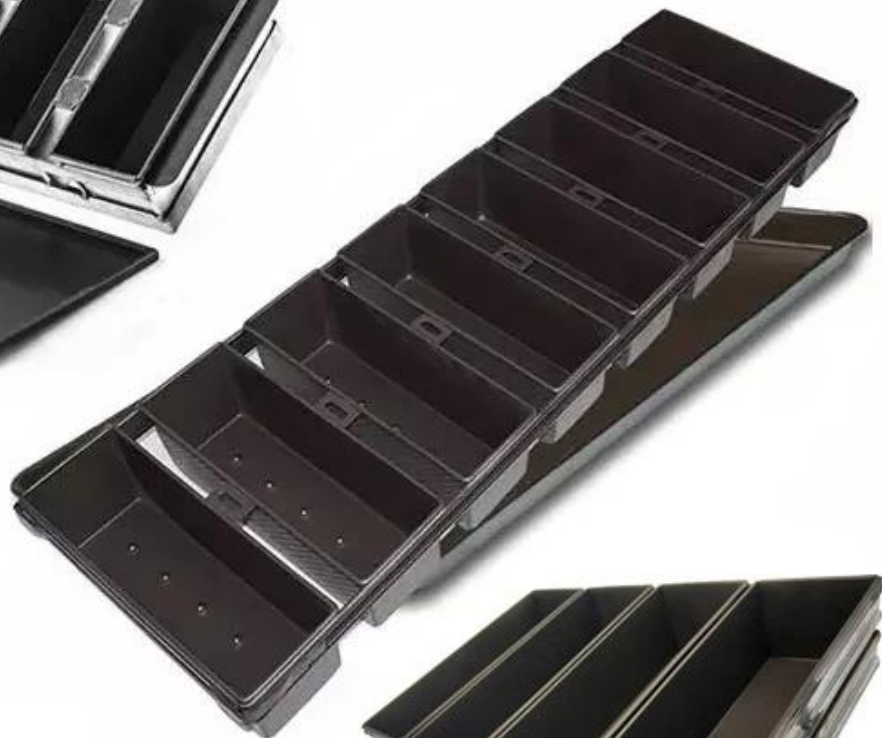

Customized shape
Customized size
Rack matched

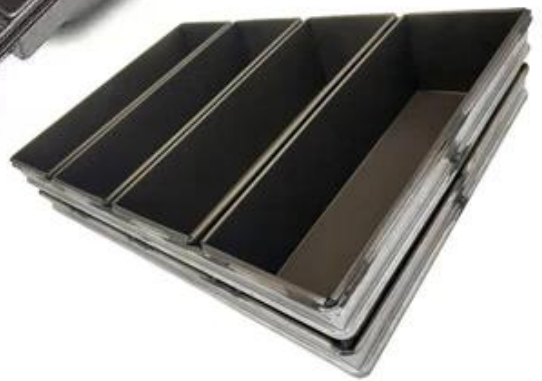

Customized Single Loaf Pan

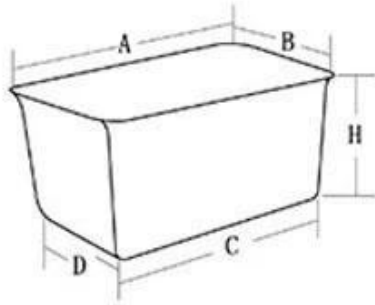

- A. Top length of the item
- B. Top width of the item
- C. Bottom length of the item
- D. Bottom width of the item
- H. Height

Customized Strapped Loaf Pan Sets

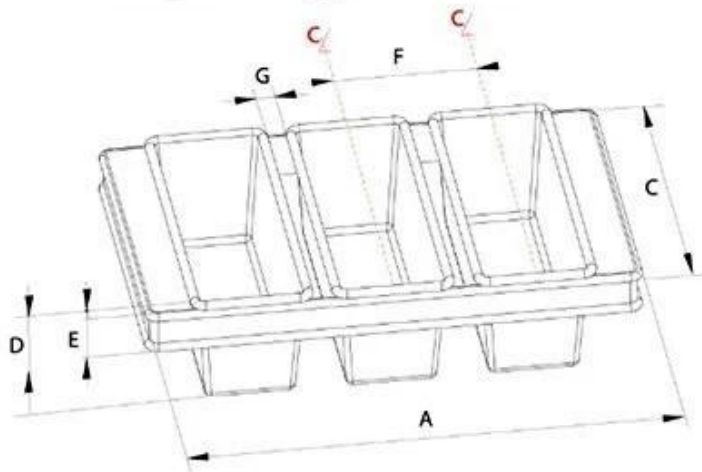

- A. Overall Length
- C. Overall Width
- D. Depth
- E. Frame Height
- F. Center-to-center
- G. Pan Distance



Flat handle



Frame handle



no handle

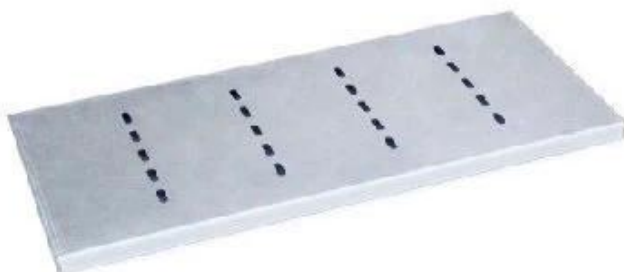

Matching lid (Drop Style)

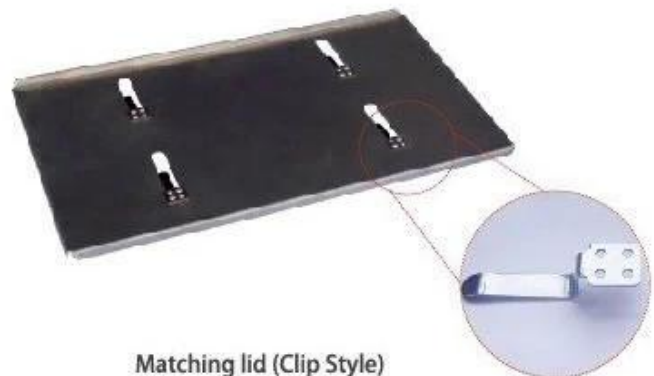

Matching lid (Clip Style)

Factory pictures

Tsingbuy [bread & loaf pans factory](#) also produces sheet pan, loaf pan, baguette pan, cupcake baking pan, cake pan etc for bakeries, food factories, restaurants for commercial use. ODM&OEM service is our greatest strength. Welcome to contact us if you are looking for commercial baking pans.



Loaf Pan

Tsingbuy Industry Limited



