

# Custom Made Large Size Cavities Non Stick Strap Loaf Pan Toast Bread Mold Sandwich Baking Tin Commercial Baking Pan Set

## **Main features of large size cavities strap loaf pan toast bread baking pan set**

1. High-Quality Construction: Our loaf pan is made from durable aluminized steel with a top-notch non-stick surface. It's built to last in busy commercial kitchens and is easy to clean.
2. Efficient Design: With three cavities and cleverly placed holes at the bottom, this pan ensures even baking and helps you make more loaves at once, boosting your productivity.
3. Custom Options: We offer different strap loaf pans to suit your needs. Whether you need more cavities, different shapes, or custom sizes, we can accommodate your requirements.
4. Machinery Friendly: Our pan fits seamlessly into machinery production lines, making it perfect for large-scale baking operations in bakeries, food factories etc.
5. Affordable Quality: Tsingbuy [strap loaf pan manufacturer](#) has over 15 years of experience in commercial bakeware, and we provide top-quality products at competitive prices. Join our satisfied customers and elevate your baking game today!

## **Product images of non stick large size cavities strap loaf pan toast bread baking pan set**













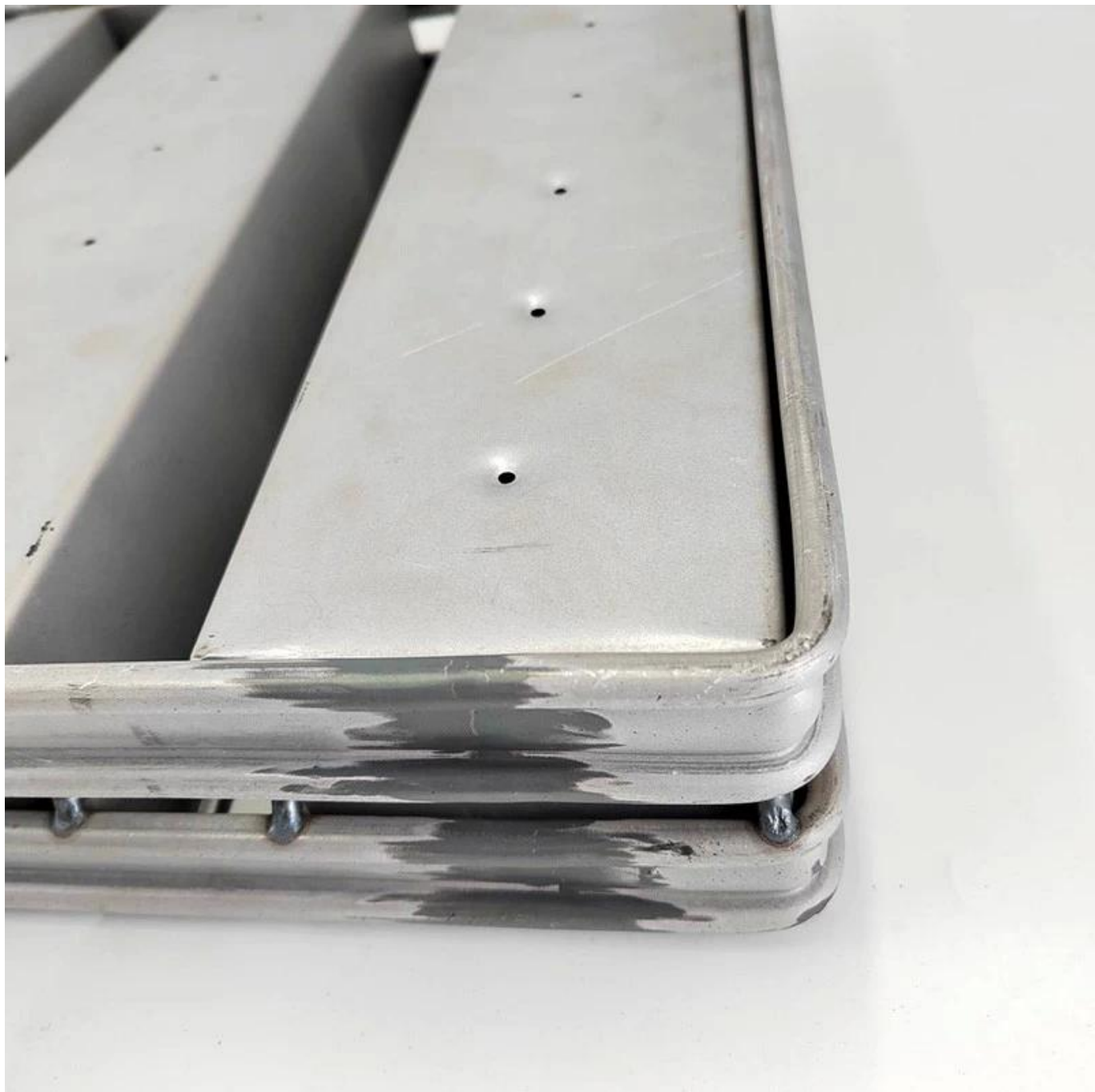





Tsingbuy is professional in making both single loaf pan and strap loaf pans. Here we share some models of strap loaf pan for your reference. Most of the strap loaf pans are custom designed according to requirements.

## More Customized Strap Loaf Pans from Tsingbuy



## Customized Single Loaf Pan

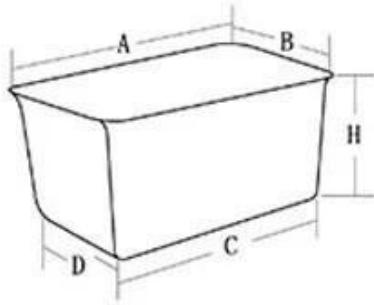

- A.Top length of the item
- B.Top width of the item
- C.Bottom length of the item
- D.Bottom width of the item
- H.Height

## Customized Strapped Loaf Pan Sets

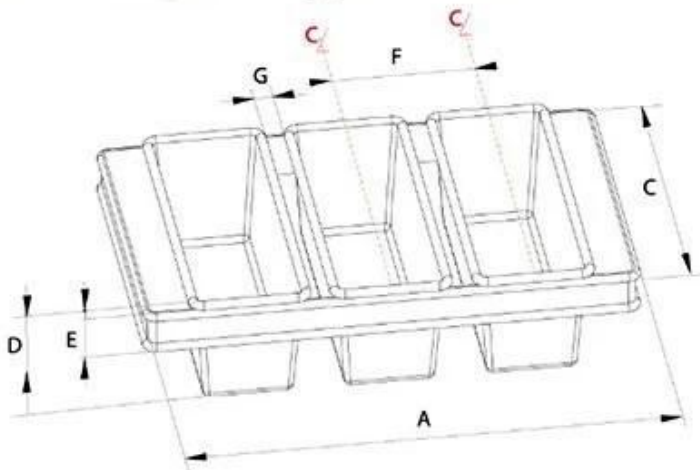

- A.Overall Length
- C.Overall Width
- D.Depth
- E.Frame Height
- F.Center-to-center
- G.Pan Distance



Flat handle



Frame handle



no handle



Matching lid (Drop Style)

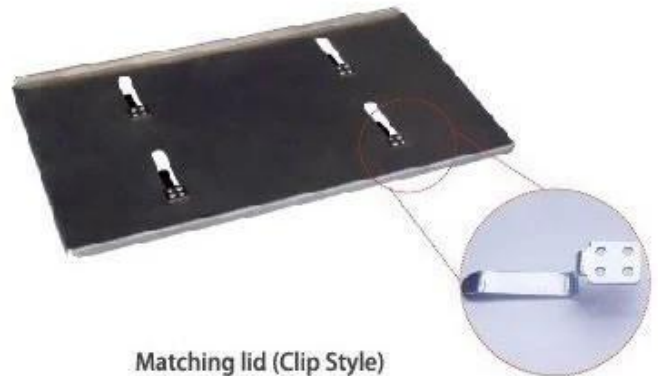

Matching lid (Clip Style)

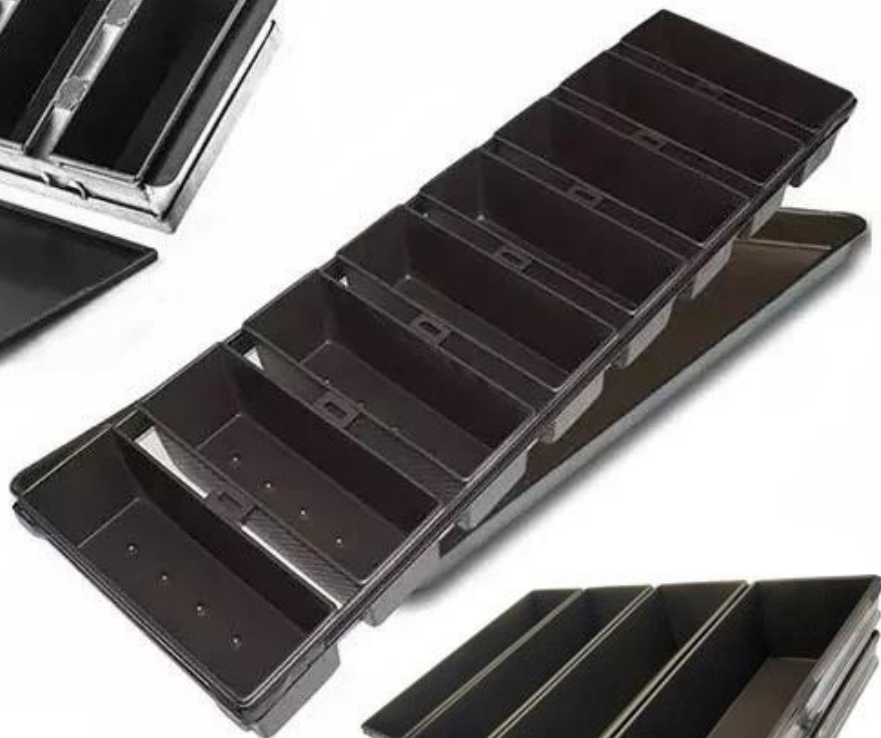

Customized shape  
Customized size  
Rack matched

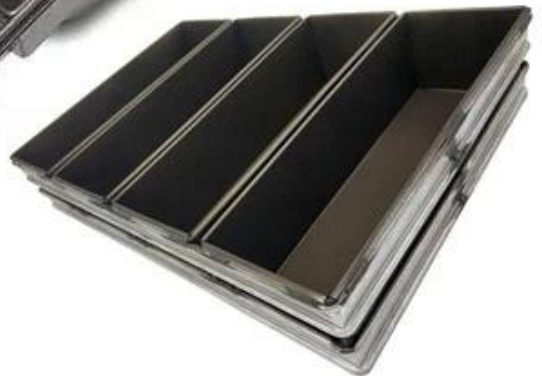

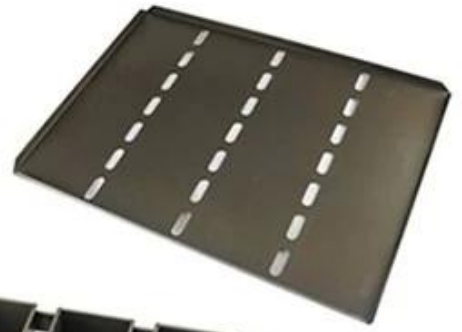

# Procedures for custom made loaf baking pans

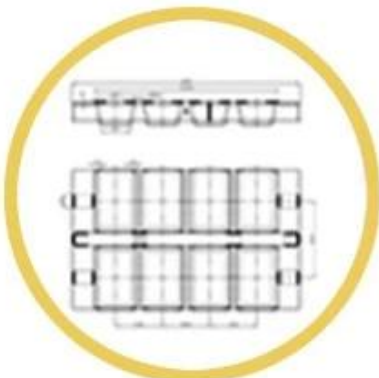

1. DRAWING



2. DESIGN



3. PRODUCT



6. SHIPPING



5. LOADING



4. PACKING



**Custom Made  
Strap Loaf Pan  
Used with  
Bakery Trolley**

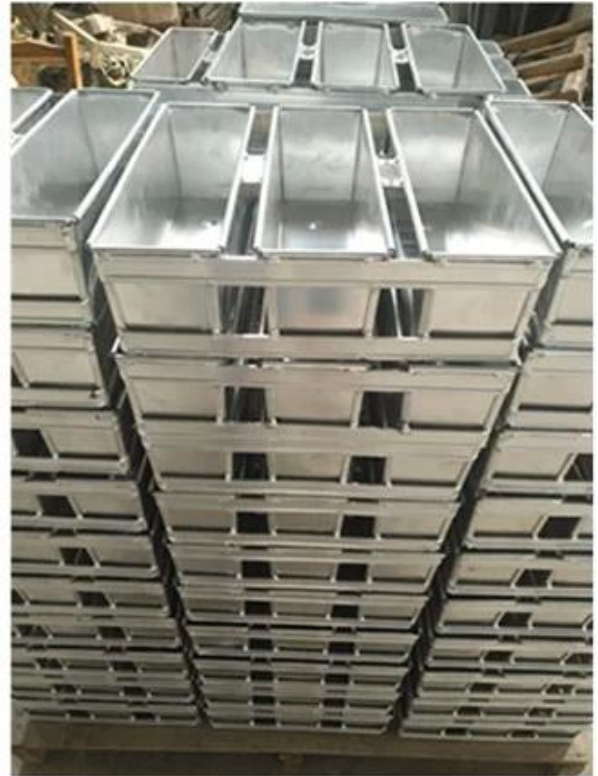

**More types of single bread loaf baking pan for home kitchen, bakery, restaurant etc**

Here are some classic models of single loaf bread baking pan from Tsingbuy [non stick loaf pan supplier](#).

# Single Loaf Pan



natural surface



corrugated



full perforation



nonstick



corrugated



golden color



holes at bottom



full perforation



custom size









Besides [bread loaf pan wholesale](#), Tsingbuy bakeware manufacturer also provides custom design and wholesale of other commercial bakeware, such as sheet pans, baguette pans, loaf pans, multi-mould baking pans, bakery trolley, cake pans etc. Welcom to consult us at any time.

