

304 Stal nierdzewna teel Pierścionek z musuem w kształcie serca Formy do pieczenia w kształcie pierścienia

Główne cechy w kształcie serca stal nierdzewna foremki do ciast z pierścionkiem z musu

Wysokiej jakości stal nierdzewna 304

Wysokiej jakości materiał ze stali nierdzewnej, który może bezpośrednio kontaktować się z żywnością, bezpieczny w użyciu, o wysokiej wytrzymałości, niełatwy do odkształcenia, niełatwy do rdzewienia i doskonale odporny na korozję.

Konstrukcja krawędzi rolki

Specjalna konstrukcja krawędzi curlingu zarówno górnej, jak i dolnej, bez skrobienia, łatwa do zabrania i umieszczenia

Perforacja na stali nierdzewnej jest opcjonalna

Perforowana powierzchnia jest dobra do równomiernego ogrzewania i szybkiego rozpraszania ciepła. Możesz wybrać, czy ma być perforowany zgodnie z własnymi wymaganiami.

Różne kształty i wiele rozmiarów dla opcji

Okrągłe, owalne, kwadratowe, prostokątne, serduszko, sześciokątne i wiele innych kształtów są opcjonalne, tworząc dowolnie wykwinne dzieła sztuki.

Zdjęcia serc w kształcie s stal nierdzewna foremki do ciast z pierścionkiem z musu





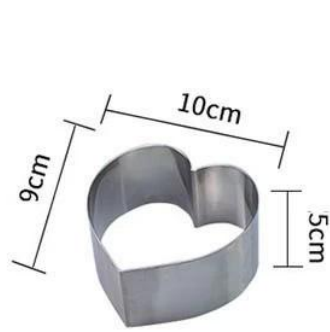

4 inch

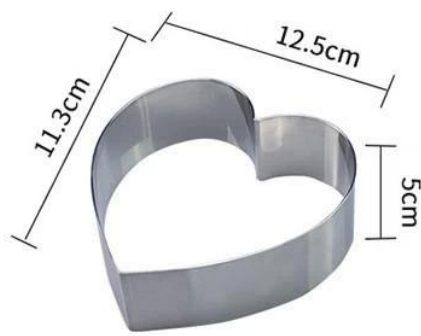

5 inch

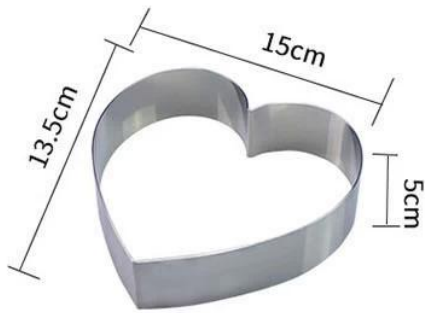

6 inch

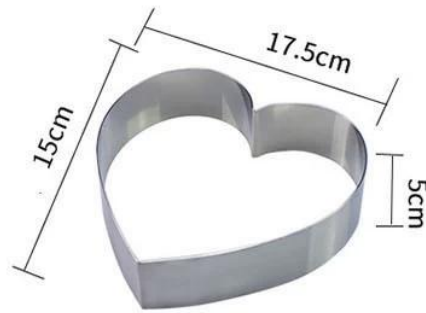

7 inch

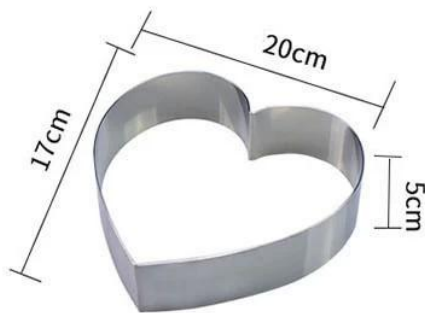

8 inch

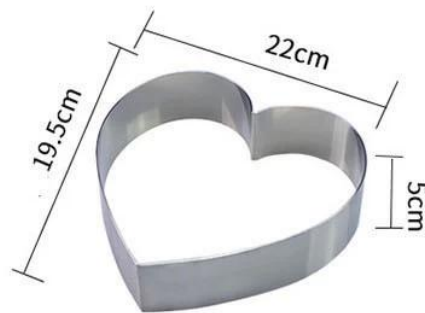

9 inch

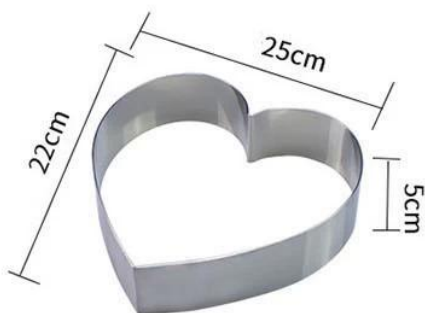

10 inch







Inne formy do pieczenia ciast, które mogą Cię zainteresować

Oto więcej form do pieczenia ciast od Tsingbuy [producent form do ciast](#) . Niezależnie od tego, czy szukasz zwykłej formy do pieczenia ciasta, czy szukasz formy do ciasta na zamówienie, zapraszamy do nas.



Non-stick Coated Cake Pans



Anodized Surface



Custom Size



Custom Design





non-stick coated

**Fixed bottom
Square
Rectangular**



anodized surface



Detachable / removable bottom







Pokaz fabryczny

Oprócz [wyprzedaż formy do ciasta na serce](#), Producent wyrobów piekarniczych Tsingbuy zapewnia również aluminiowe formy do ciast, aluminiowe tacki, aluminiową formę do pieczenia bagietek, bochenek chleba, wieloformowe formy do pieczenia ciastek itp., A także usługi ODM i OEM zaopatrzenia piekarni. Zapraszamy do kontaktu z nami w każdej chwili.

Production Machines



Automatic cutting machine



Automatic punching machine



Punching machine



Bending machine



Sand blasting machine



Drying machine

Our Advantages



Professional machine



Standard production flow



Experienced workers



Clean & tidy warehouse



Quick production fast dispatch

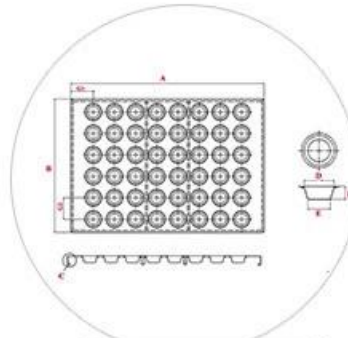

ODM & OEM service