

## Tinapay tinapay pan toast baking magkaroon ng amag aluminyo pan na may takip

### **Pangunahing mga tampok ng aluminum corrugated bread loaf pan may lid**

1. M.ade ng 1.0mm thick. aluminyo haluang metal, Matibay para sa mahabang buhay ng serbisyo.
2. Pagkain-lichtas at corrugated, corrugated ibabaw hindi sticky, madaling demould, madaling linisin
3. Ang ilalim na butas ay opsyonal para sa mas mahusay Circulation of hot air and uniform heating..
4. Ang wire sa disenyo ng rim ay ginagawang mas matibay at hindi madaling pagpapapangit para sa mahabang buhay ng Srvice.
5. Maramihang pag-andar para sa paggawa ng mga sandwich, toast, tradisyonal na tinapay na tinapay atbp.
6. Available ang ODM & OEM Tsingbuy. propesyonal **Pullman Loaf Pan Manufacturer**..
7. Tsingbuy. [Bread Loaf Pan Manufacturer](#).ay nagbibigay ng pasadyang bakeware para sa internasyonal na merkado para sa higit sa 12 taon.

### **Mga larawan ng produkto ng. corrugated aluminum bread baking pan na may cover.**

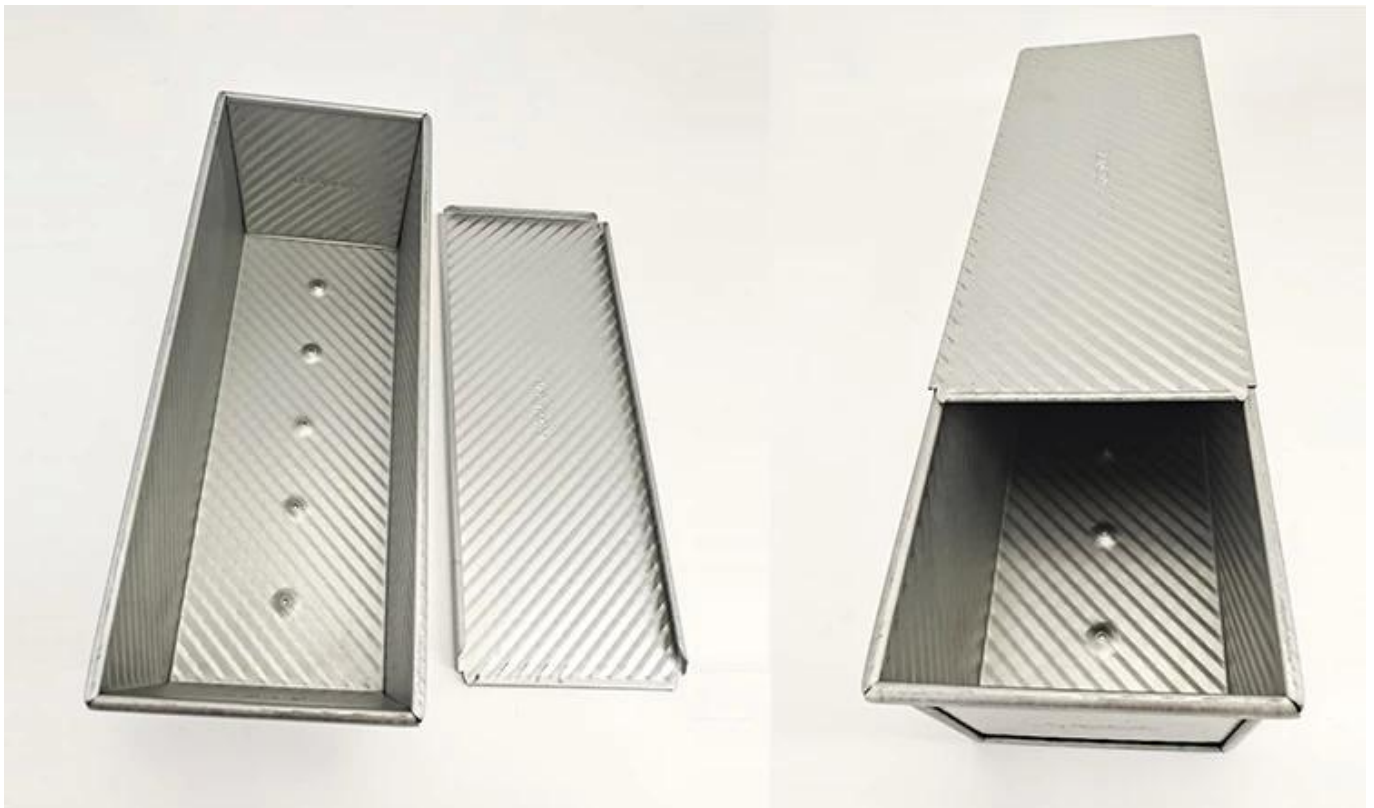





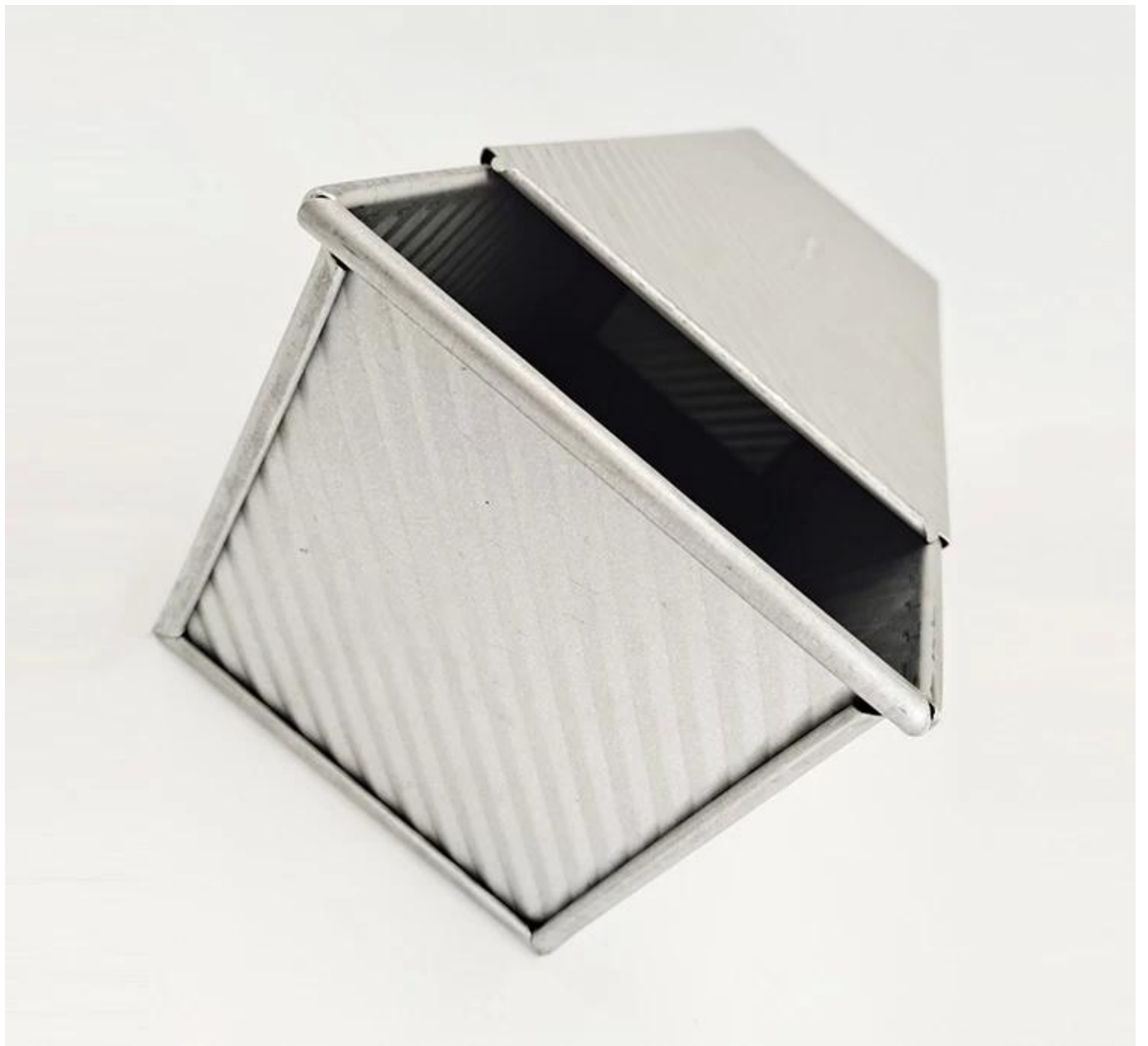

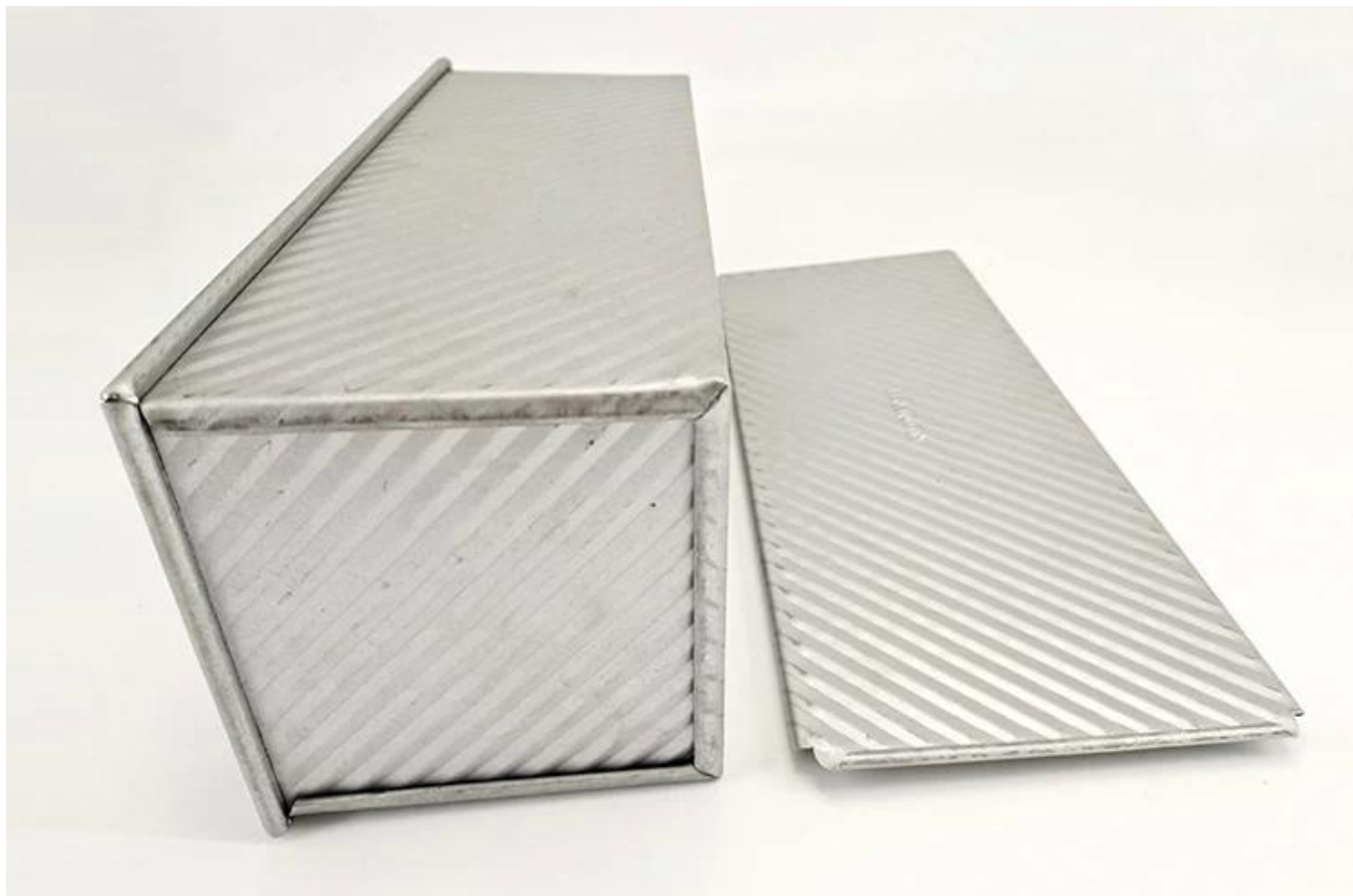

## **Higit pang mga uri ng Aluminum Pans & Bread Loaf Pans para sa iyong impormasyon**

Narito ang higit pang mga uri para sa iyong impormasyon mula sa Tsingbuy [Aluminum Pans Factory](#).

Ang aming pullman loaf pans ay dinisenyo sa S.Imple style, maganda at praktikal sa Mabilis na pagpapadaloy ng init, kahit pagpainit, hindi madaling lumitaw Bahagyang marahas.

Opsyonal na materyal: Aluminum, aluminized na bakal, hindi kinakalawang na asero

Mga opsyon sa pagbubutas: Walang pagbubutas, bottom-perforated, all-perforated

Paggamit ng eksena: single loaf pan, strap loaf pan

Mga pagpipilian sa ibabaw: makinis, corrugated, no-coating, Teflon non-stick, silicone non-stick.

Sukat: Anumang laki

LID: may takip o hindi bilang iyong pangangailangan.

# customized single loaf pan





Teflon coating

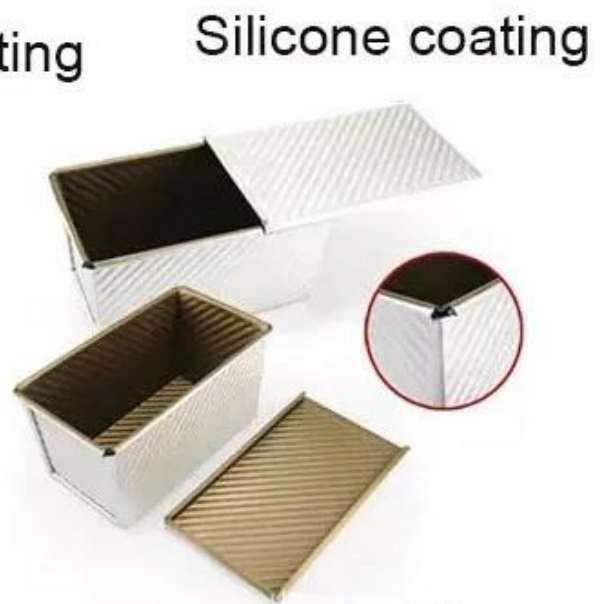

Silicone coating



Material:

Aluminum alloy

Aluminized steel



Pasadyang Ang pagmamanupaktura ng strap loaf pan ay isa sa aming pinakamalaking lakas, maligayang pagdating para sa higit pang impormasyon.

Nakikipag-ugnayan kami sa paggawa ng bakeware para sa higit sa 12 taon at nagbigay ng libu-libong bakesa para sa mga internasyonal na customer. Gamit ang aming pagluluto Pan., madali mong gawin ang lahat ng uri ng masarap na pagkain, Chiffon cakeS., mousse cake, Pound. cake, cake ng keso, atbp

## More Customized Strap Loaf Pans from Tsingbuy





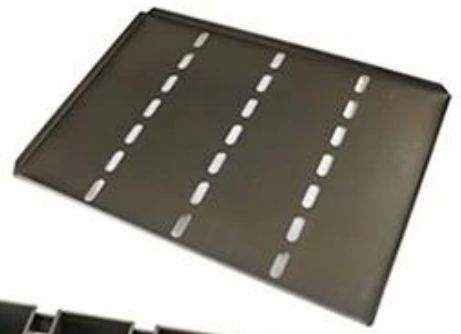



Customized shape  
Customized size  
Rack matched

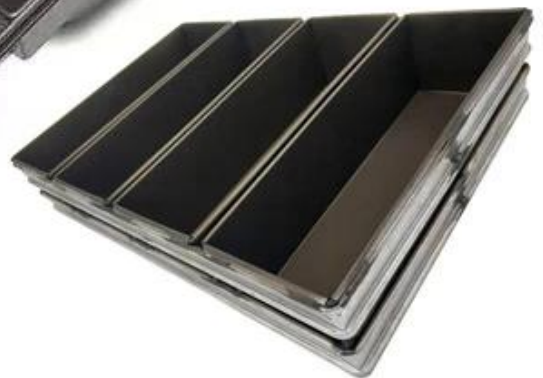

## Customized Single Loaf Pan

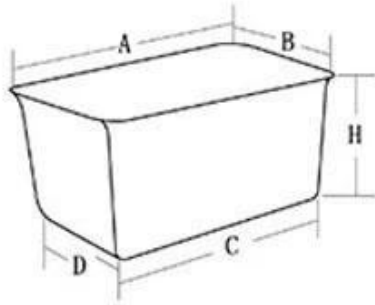

- A.Top length of the item
- B.Top width of the item
- C.Bottom length of the item
- D.Bottom width of the item
- H.Height

## Customized Strapped Loaf Pan Sets

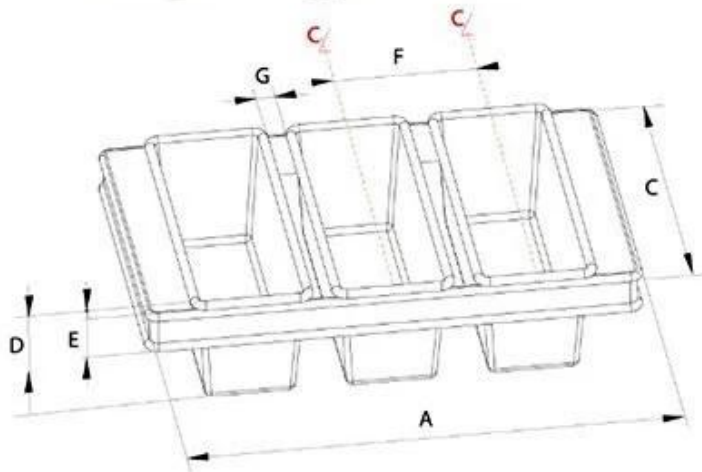

- A.Overall Length
- C.Overall Width
- D.Depth
- E.Frame Height
- F.Center-to-center
- G.Pan Distance



Flat handle



Frame handle

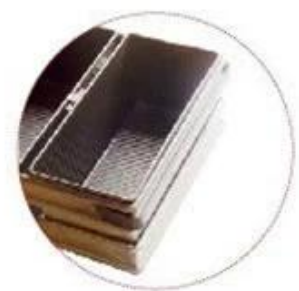

no handle

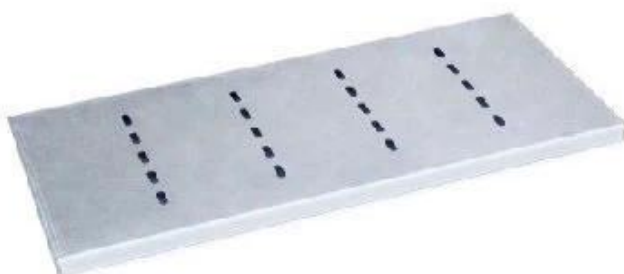

Matching lid (Drop Style)

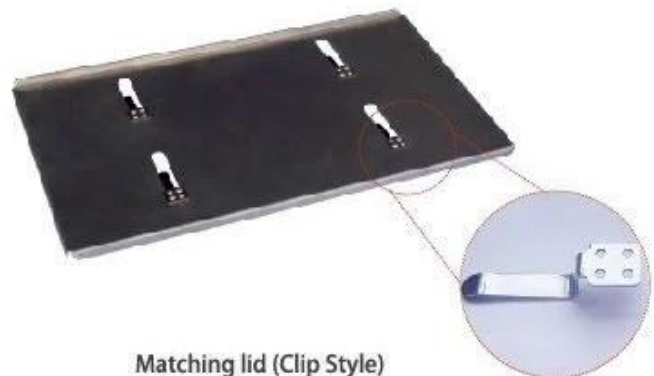

Matching lid (Clip Style)

## Mga larawan ng pabrika



## Loaf Pan

Tsingbuy Industry Limited



Maligayang pagdating sa pagbisita sa amin Tsingbuy komersyal at pang-industriya [Strap loaf pan na](#)

may supplier ng talukap ng mata.