

Wholesale Aluminum Square Non Stick Mini Small Bread Loaf Pans

Pangunahing tampok ng aluminum square non stick mini small bread loaf pans

1. gawa sa 1.0mm makapal na aluminyo haluang metal, matibay para sa mahabang buhay ng serbisyo.
2. Food-safe non-stick surface ay hindi malagkit, madaling i-demould, madaling linisin
3. dinisenyo may cover, maginhawang gumawa ng American toast na may patag na gilid. Ang corrugated surface ay ginagawang mas maginhawang i-demould.
4. Ang ilalim na butas ay opsyonal para sa mas mahusay na sirkulasyon ng mainit na hangin at pareparehong pag-init.
5. Wire sa rim disenyo ay ginagawang mas matibay at hindi madaling pagpapapangit para sa mahabang service buhay.
6. Multiple function para sa paggawa ng mga sandwich, toast, tradisyonal na tinapay na tinapay atbp.
7. Available ang ODM at OEM sa Tsingbuy professional [supplier ng maliit na kawali](#).
8. Ang Tsingbuy ay isang propesyonal na supplier na buong kapurihan na gumawa ng mataas na kalidad na mga baking tray, pullman loaf lata at nagbigay ng custom na bakeware para sa internasyonal na merkado sa loob ng mahigit 12 taon.

Mga larawan ng produkto ng aluminum square non stick mini small bread loaf pans

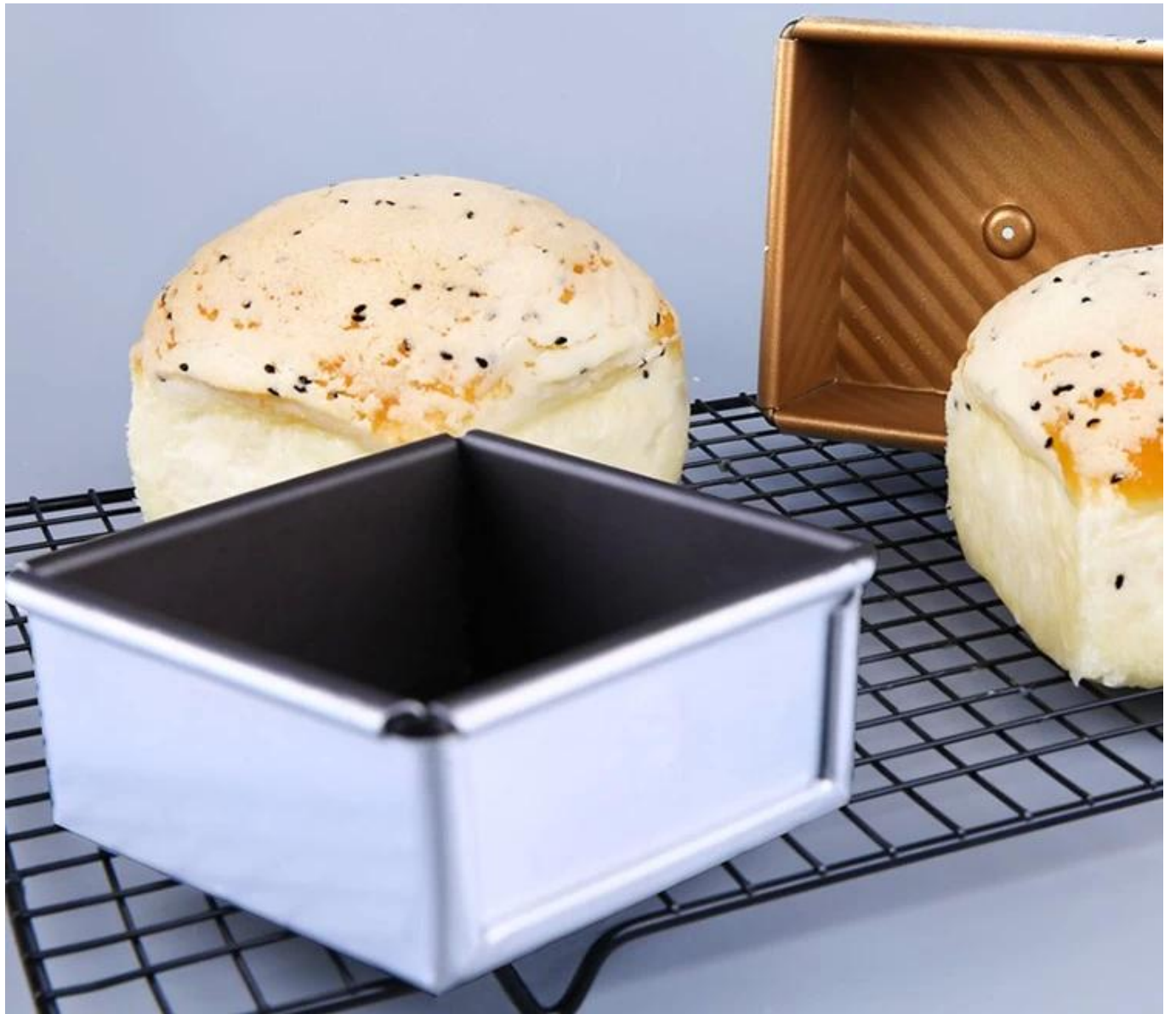

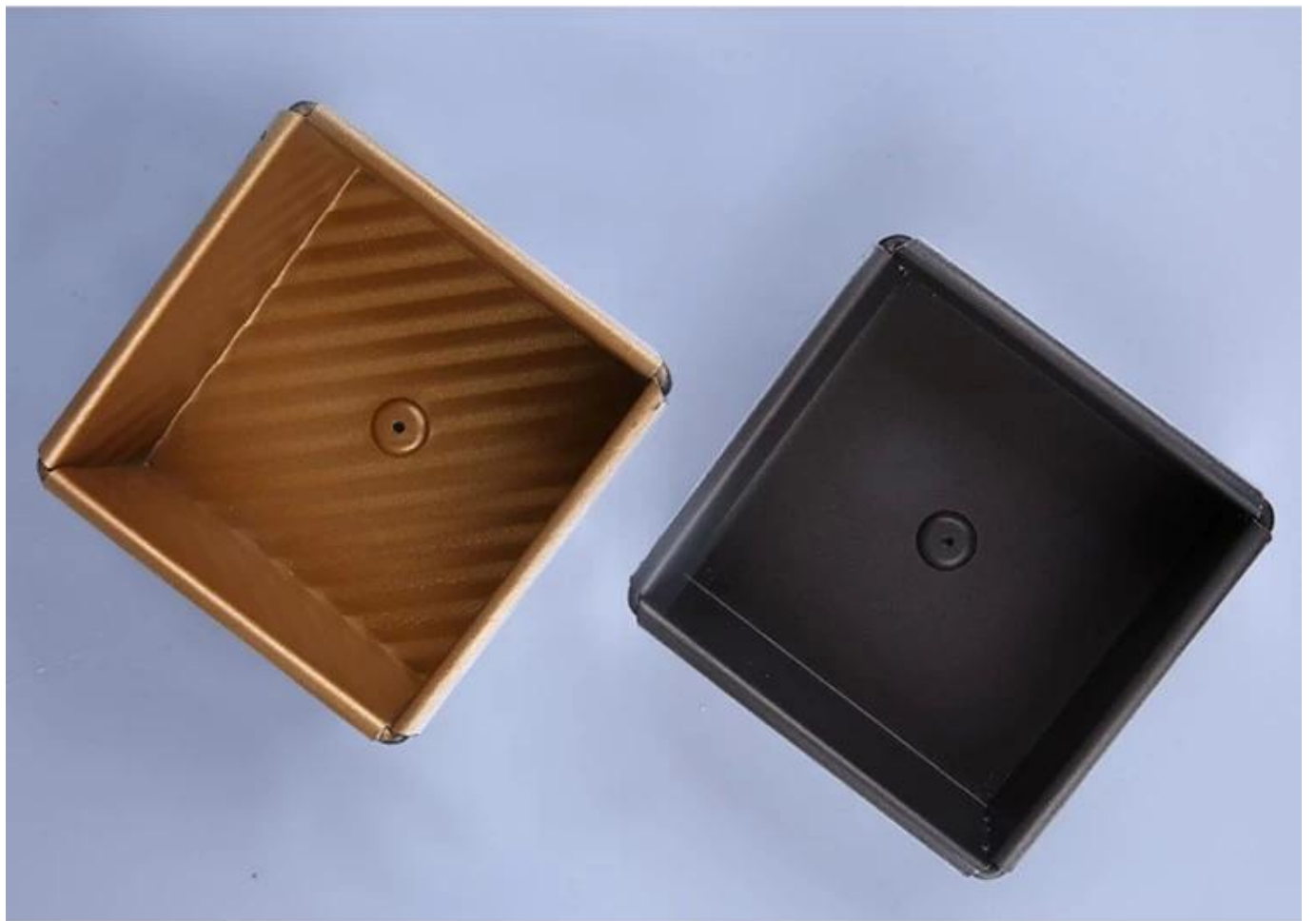



Aluminum
Bread Baking Pan

1.0mm thick

Size

Top size

100x100x49mm

Bottom size

98x96mm













Higit pang mga uri ng tinapay at mga kawali para sa iyong impormasyon

Narito ang higit pang mga disenyo para sa mga kawali ng tinapay.

Ang aming Pullman loaf pans ay idinisenyo sa simpleng istilo, maganda at praktikal na may mabilis na pagpapadaloy ng init, kahit na pag-init, hindi madaling lumitaw na bahagyang pagkapaso.

Opsyonal na materyal: aluminyo, aluminized na bakal, hindi kinakalawang na asero

Mga opsyon sa pagbubutas: walang butas, butas sa ilalim, butas-butis

Gamit ang eksena: single loaf pan, strap loaf pan

Mga opsyon sa ibabaw: makinis, corrugated, walang patong, Teflon non-stick, silicone non-stick

Sukat: anumang laki

Takip: may takip o hindi bilang iyong kinakailangan.

customized single loaf pan





Bukod sa [non stick bread pan pakyawan](#), ang custom na pagmamanupaktura ng strap loaf pan ay isa rin sa aming pinakamalaking lakas, maligayang pagdating para sa higit pang impormasyon.

Kami ay nakikibahagi sa pagmamanupaktura ng bakeware sa loob ng mahigit 12 taon at nagsusuplay ng libu-libong bakeware para sa mga internasyonal na customer. Gamit ang aming baking pan, madali kang makakagawa ng lahat ng uri ng masasarap na pagkain, Chiffon cake, mousse cake, Pound cake, cheese cake, atbp

More Customized Strap Loaf Pans from Tsingbuy



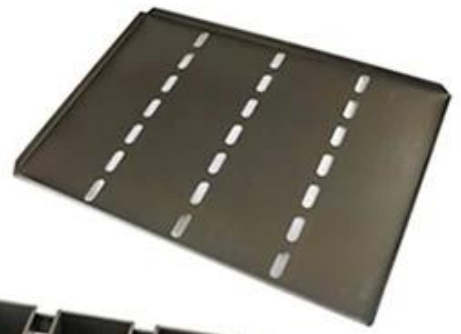



Customized shape
Customized size
Rack matched

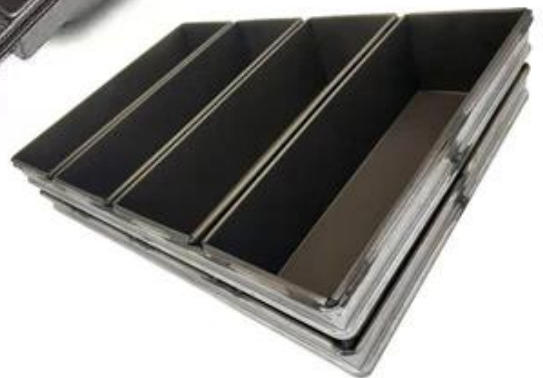

Customized Single Loaf Pan

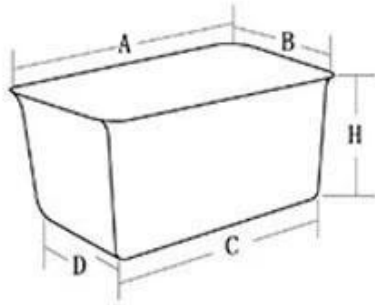

- A.Top length of the item
- B.Top width of the item
- C.Bottom length of the item
- D.Bottom width of the item
- H.Height

Customized Strapped Loaf Pan Sets

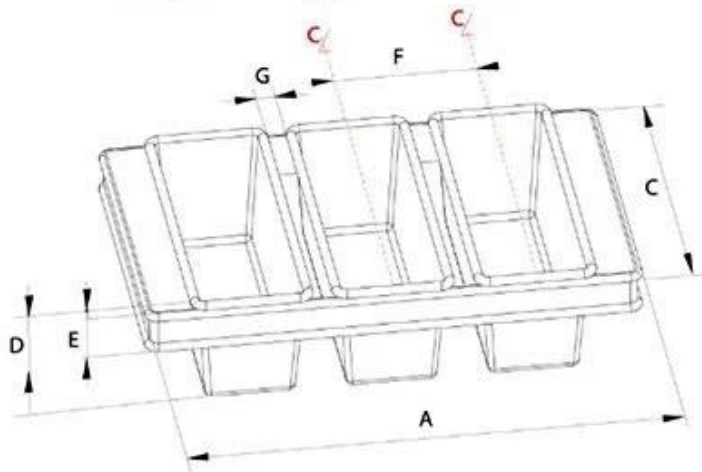

- A.Overall Length
- C.Overall Width
- D.Depth
- E.Frame Height
- F.Center-to-center
- G.Pan Distance



Flat handle



Frame handle



no handle



Matching lid (Drop Style)

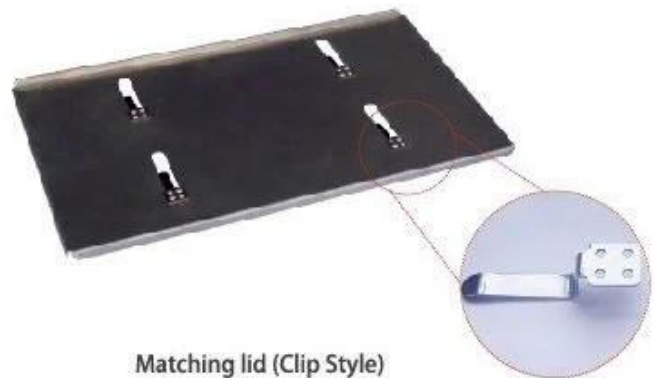

Matching lid (Clip Style)

Mga larawan ng pabrika

Tsingbuy [pabrika ng square bread pan](#) gumagawa din ng sheet pan, loaf pan, baguette pan, cupcake baking pan, cake pan atbp para sa mga panaderya, pabrika ng pagkain, restaurant para sa komersyal na paggamit. Ang serbisyo ng ODM&OEM ay ang aming pinakamalaking lakas. Maligayang pagdating upang makipag-ugnay sa amin kung naghahanap ka ng mga komersyal na baking pan.



Loaf Pan

Tsingbuy Industry Limited



