

# **Isang pirasong Materyal na Molded Aluminum Non Stick Pullman Bread Loaf Tin Toast Bread Baking Pan na may Takip para sa Kusina sa Bahay at Paggamit ng Panaderya sa Restaurant**

## **Pangunahing tampok ng one-piece molded aluminum non stick pullman bread loaf tin toast bread baking pan na may lid**

1. **Matibay na Materyal na Aluminum:** Ginawa gamit ang mataas na kalidad na aluminyo, tinitiyak ng loaf bread pan na ito ang mahusay na pagdadala at pamamahagi ng init, na nagreresulta sa pantay na pagkaluto ng mga produkto. Sa kapal na 1.0mm, ginagarantiyahan nito ang tibay at mahabang buhay, na ginagawa itong maaasahang karagdagan sa iyong arsenal sa kusina.
2. **Pinag-isipang Konstruksyon:** Dinisenyo nang may kaginhawaan sa isip, ang aming loaf bread pan ay nagtatampok ng one-piece sheet material molding. Inaalís nito ang panganib ng anumang mga tahi o kasukasuan na maaaring magdulot ng pagtagas o hindi pantay na pagluluto. Bukod pa rito, ang pan ay nilagyan ng mga butas sa ibaba, na nagpapahintulot sa labis na kahalumigmigan na makatakas at nagpo-promote ng pinakamainam na daloy ng hangin. Ang kasamang takip ay nagbibigay ng airtight seal, na nagpapanatili ng pagiging bago at nagpapahusay ng lasa.
3. **Double-sided Non-Stick Coating:** Magpaalam sa pakikibaka sa pag-alis ng iyong mga lutong likha mula sa kawali! Ipinagmamalaki ng aming loaf bread pan ang isang double-sided non-stick coating, na pumipigil sa iyong tinapay o cake na dumikit sa ibabaw. Ang feature na ito ay ginagawang walang kahirap-hirap na ilabas ang iyong mga masasarap na likha, na nagbibigay sa iyo ng perpektong hugis na mga tinapay sa bawat oras at pinapasimple ang proseso ng paglilinis.
4. **Versatile Capacity and Functions:** Sa isang mapagbigay na 450g capacity, ang loaf bread pan na ito ay tumutugon sa iyong iba't ibang pangangailangan sa baking. Nagluluto ka man ng mga tradisyunal na tinapay, mabangong cake, o kahit na nag-eeksperimento sa iba pang mga recipe, nakuha ng pan na ito ang iyong saklaw. Nagbibigay-daan sa iyo ang multi-functionality nito na tuklasin ang malawak na hanay ng mga culinary delight, na ginagawa itong isang kailangang-kailangan na tool sa iyong kusina.
5. **Propesyonal na Serbisyo ng ODM&OEM:** Tsingbuy [pabrikang pullman loaf lata](#) ay nag-aalok ng mga propesyonal na serbisyo ng ODM at OEM na may higit sa 15 taong karanasan. Nangangahulugan ito na hindi mo lamang masisiyahan ang mahusay na kalidad ng aming kawali ng tinapay, ngunit nagbibigay din kami ng pagkakataon para sa mga panadero sa kusina sa bahay at mga wholesaler ng bakeware na itaas ang kanilang negosyo. I-customize ang pan na ito gamit ang iyong branding o disenyo, at samantalain ang aming kadalubhasaan upang lumikha ng isang natatanging produkto na sumasalamin sa iyong pananaw.

**Mga larawan ng produkto ng one-piece molded aluminum non stick pullman bread loaf tin toast bread baking pan na may lid**

## One Piece Integrated Molding Bread Loaf Pan with Lid



# Integrated Molding Aluminum Non Stick Bread Loaf Pan with Lid



## Holes at Bottom for Ventilation



ABLE AND EASY TO DEM

## Enjoy Your DIY with Family



Curled Edges for Four Sides  
Easy to Sliding-on-off cover

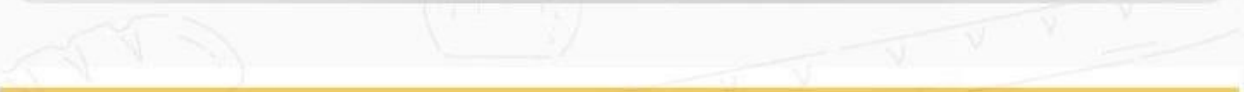



# Double-side Non Stick Coated Bread Loaf Pan with Lid







450g dough

baking pan weight: 309g

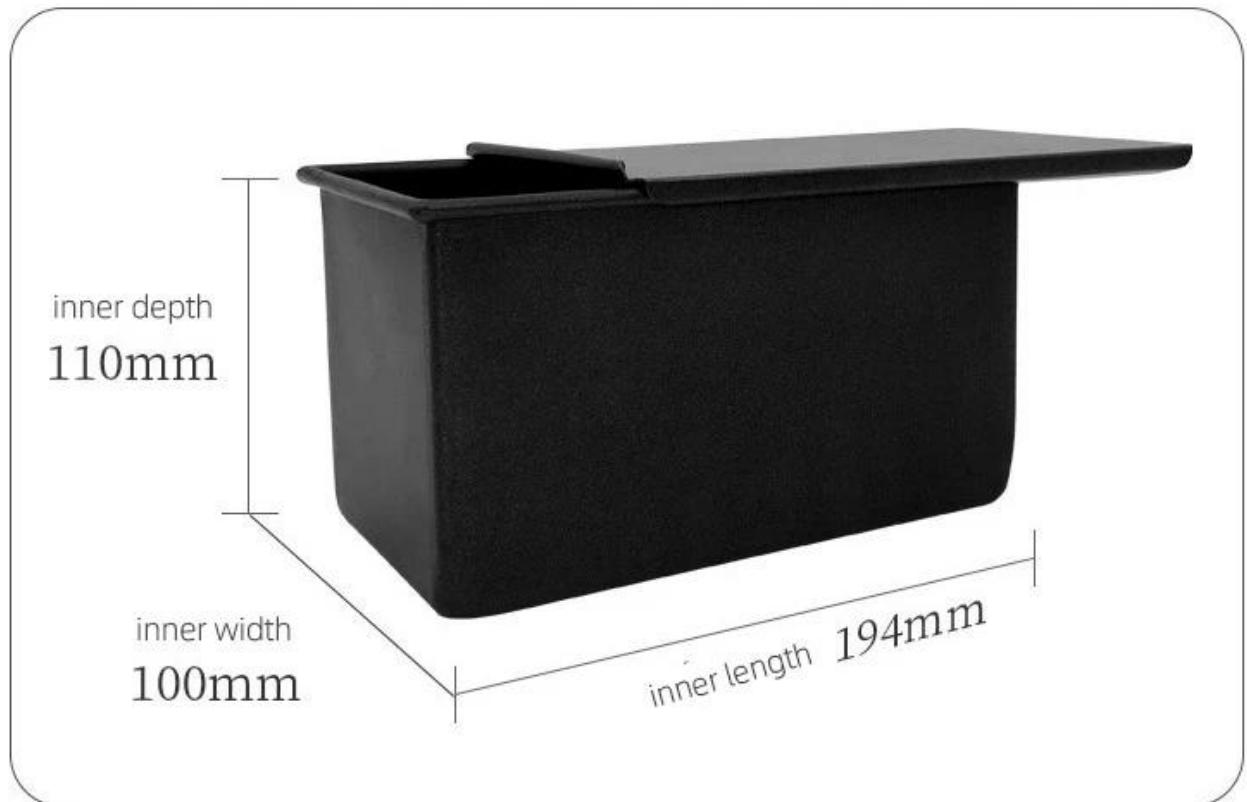

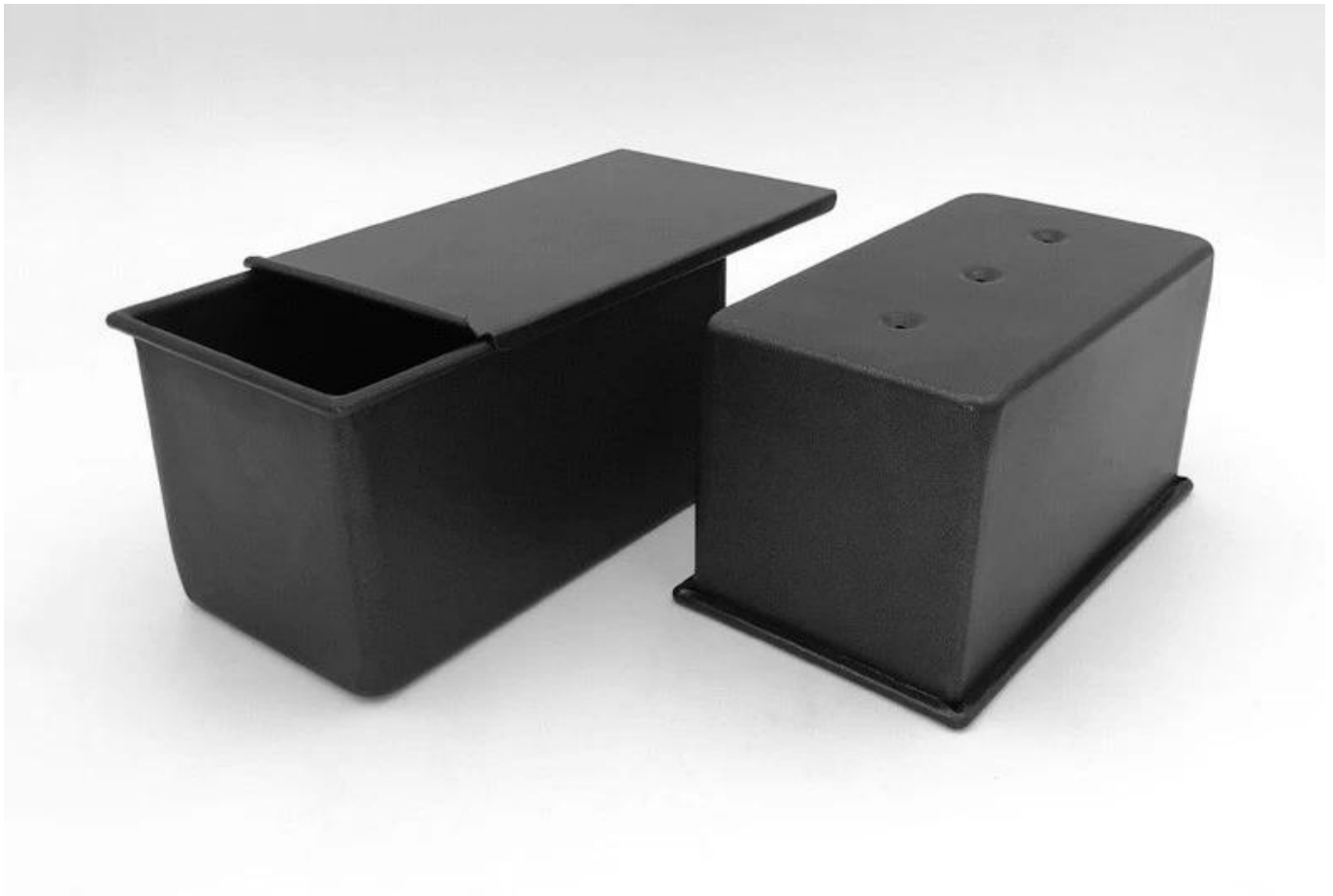

## **Higit pang mga uri ng tinapay at tinapay na kawali para sa iyong impormasyon**

Narito ang higit pang mga disenyo para sa mga kawali ng tinapay.

Ang aming Pullman loaf pans ay idinisenyo sa simpleng istilo, maganda at praktikal na may mabilis na pagpapadaloy ng init, kahit na pag-init, hindi madaling lumitaw na bahagyang pagkapaso.

Opsyonal na materyal: aluminyo, aluminized na bakal, hindi kinakalawang na asero

Mga opsyon sa pagbubutas: walang butas, butas sa ilalim, butas-butis

Gamit ang eksena: single loaf pan, strap loaf pan

Mga opsyon sa ibabaw: makinis, corrugated, walang patong, Teflon non-stick, silicone non-stick

Sukat: anumang laki

Takip: may takip o hindi bilang iyong kinakailangan.

# customized single loaf pan





Material:

Aluminum alloy

Aluminized steel

Bukod sa [pakyawan na aluminyo na mga kawali](#) sa isang kahon, ang ODM at OEM na serbisyo ng sheet pan, baguette pan, multi-mould cupcake pan, strap loaf pan ay isa rin sa aming pinakamalaking lakas, maligayang pagdating para sa karagdagang impormasyon.

Kami ay nakikibahagi sa pagmamanupaktura ng bakeware sa loob ng mahigit 12 taon at nagsusuplay ng libu-libong bakeware para sa mga internasyonal na customer. Gamit ang aming baking pan, madali kang makakagawa ng lahat ng uri ng masasarap na pagkain, Chiffon cake, mousse cake, Pound cake, cheese cake, atbp

## More Customized Strap Loaf Pans from Tsingbuy



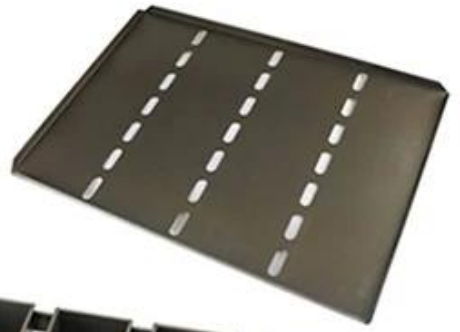

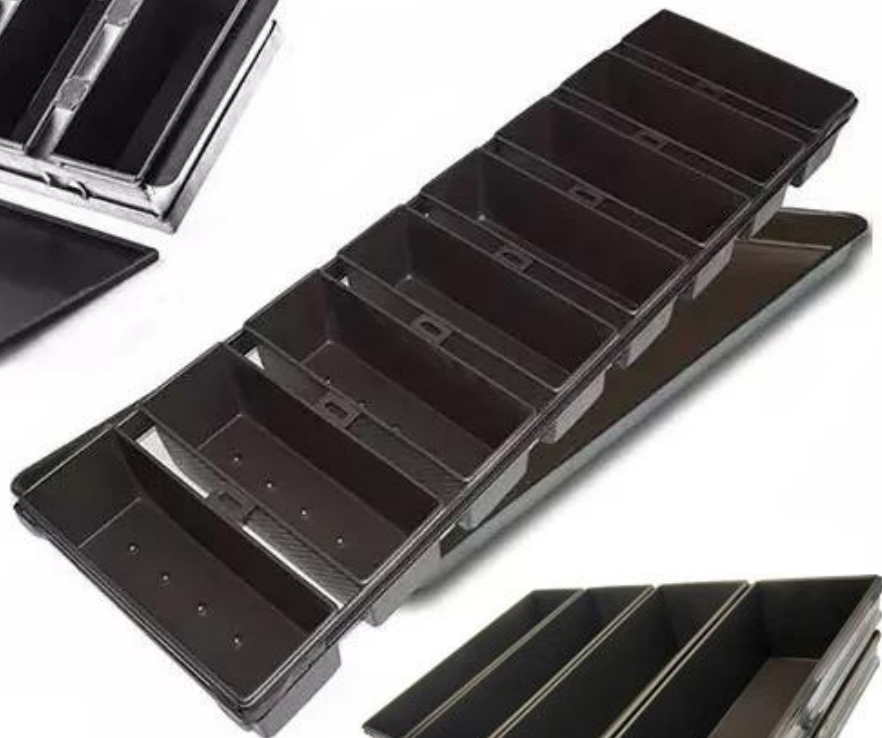

Customized shape  
Customized size  
Rack matched

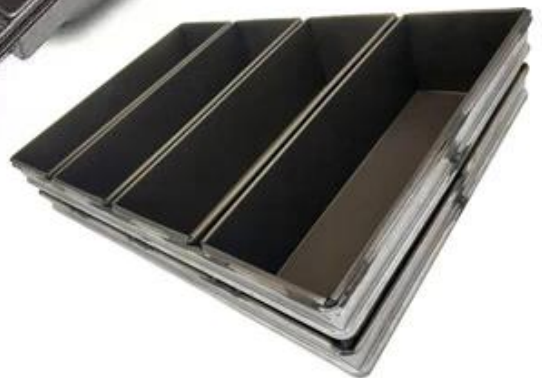

## Customized Single Loaf Pan

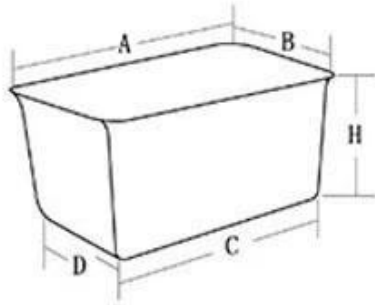

- A. Top length of the item
- B. Top width of the item
- C. Bottom length of the item
- D. Bottom width of the item
- H. Height

## Customized Strapped Loaf Pan Sets

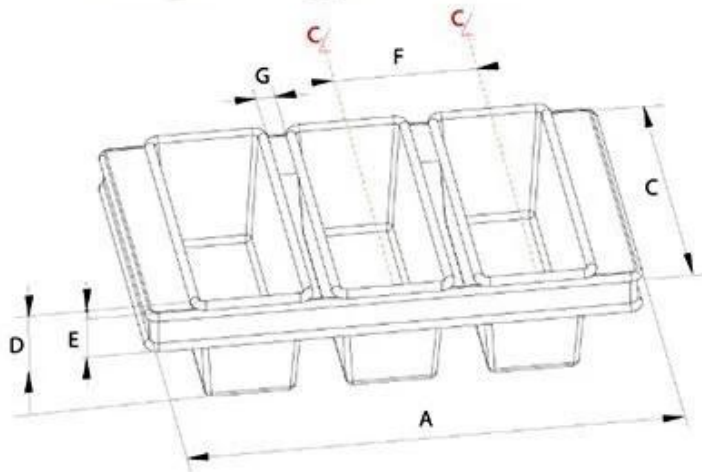

- A. Overall Length
- C. Overall Width
- D. Depth
- E. Frame Height
- F. Center-to-center
- G. Pan Distance



Flat handle



Frame handle



no handle

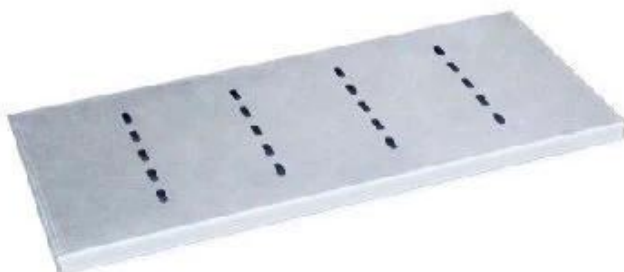

Matching lid (Drop Style)

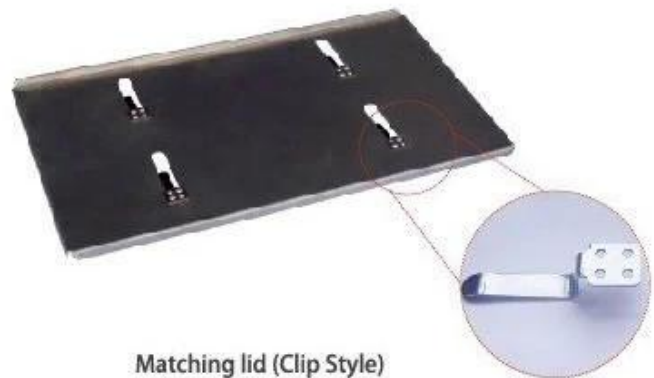

Matching lid (Clip Style)



## Mga larawan ng pabrika

Bukod sa loaf bread pans, Tsingbuy [supplier ng lata ng tinapay](#) gumagawa din ng sheet pan, loaf pan, baguette pan, cupcake baking pan, cake pan atbp para sa mga panaderya, pabrika ng pagkain, restaurant para sa komersyal na paggamit. Ang serbisyo ng ODM&OEM ay ang aming pinakamalaking lakas. Maligayang pagdating upang makipag-ugnay sa amin kung naghahanap ka ng mga komersyal na baking pan.



### Loaf Pan

Tsingbuy Industry Limited



