

Perforated Anodized Aluminum Baking Sheet Pans, French Italian Russian Napoleon Cake Mille Feuille Puff Pastry Baking Tray, Crispy Baking Tray

Paglalarawan ng produkto ng Napoleon Dessert Millefeuille Puff Pastry Baking Tray

Ipinapakilala ang aming Napoleon dessert na Millefeuille puff pastry baking tray, ang pinakamagaling na kasama ng mga mahilig sa pastry at mga propesyonal na panadero. Ginawa nang may katumpakan at tibay sa isip, ang baking tray na ito ay idinisenyo upang itaas ang iyong karanasan sa pagluluto sa bagong taas.

Binuo mula sa mataas na kalidad na 1.5mm na makapal na aluminyo, ang baking tray na ito ay matibay at makatiis sa hirap ng madalas na mga baking session. Ipinagmamalaki din nito ang pambihirang kondaktibiti ng init, na tinitiyak na pantay ang pagluluto sa bawat oras. Ang anodized surface nito ay nagbibigay ng non-stick coating, na ginagawa para sa walang hirap na paglabas at walang problema sa paglilinis.

Sa apat na laki na mapagpipilian, mayroon kang kakayahang umangkop upang lumikha ng mga pastry ng iba't ibang dimensyon, na tumutugon sa iyong mga partikular na pangangailangan at kagustuhan. Nagluluto ka man para sa isang maliit na pagtitipon o isang malaking kaganapan, ang tray na ito ay nasasakop mo.

Isa sa mga natatanging tampok ng aming baking tray ay ang makabagong disenyo nito, na nagtatampok ng dalawang butas-butang na mga sheet na dumudulas nang walang kahirap-hirap. Ang kakaibang disenyong ito ay hindi lamang nagpapadali sa daloy ng hangin, na nagpo-promote ng pantay na pamamahagi ng init at pare-parehong pagbe-bake, ngunit pinipigilan din ang labis na pagpapalawak ng puff pastry, na tinitiyak na ang iyong mga pastry ay napanatili nang perpekto ang kanilang hugis at istraktura upang lumikha ng mukhang propesyonal na millefeuille at iba pang mga layered na pastry.

Ang versatility ay susi sa aming Napoleon dessert Millefeuille puff pastry baking tray. Bagama't mainam ito para sa paggawa ng mga katangi-tanging dessert ng French Napoleon, perpekto din ito para sa paggawa ng napakaraming iba pang delicacy, kabilang ang millefeuille, puff pastry, at crispy treat. Maaari rin itong gamitin bilang cookie baking sheet, na ginagawa itong praktikal na karagdagan sa iyong koleksyon ng bakeware sa kusina. Hayaang tumakbo ang iyong pagkamalikhain habang ginalugad mo ang walang katapusang mga posibilidad na iniaalok ng maraming nalalamang tray na ito.

Isa ka mang batikang pastry chef o baguhang panadero, itong Napoleon dessert Millefeuille puff pastry baking tray mula sa Tsingbuy [butas-butang tray tagagawa sa China](#) ay siguradong magpapalaki sa iyong baking game at magpapasaya sa iyong panlasa na may perpektong pastry sa bawat oras.

Mga Larawan ng Produkto ng Napoleon Dessert Millefeuille Puff Pastry Baking Tray



Multiple Functions

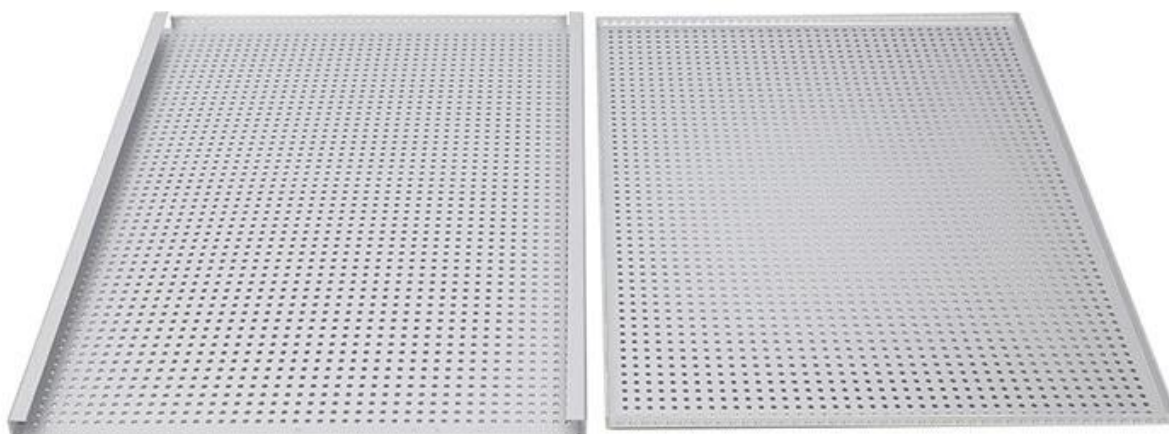

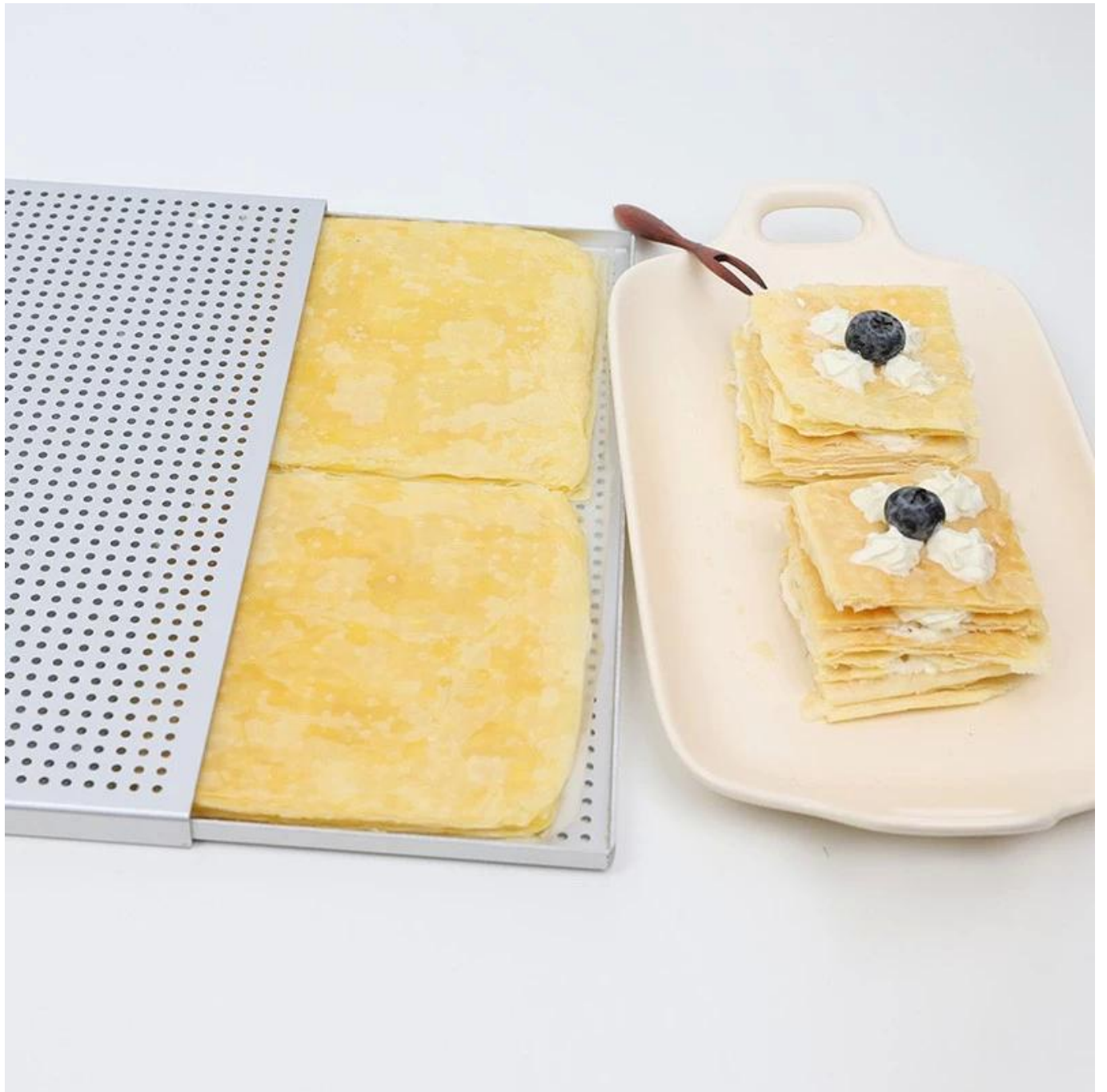





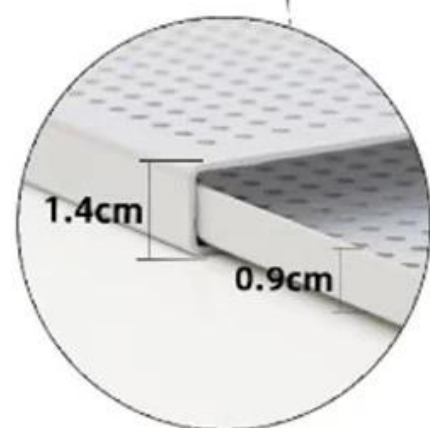

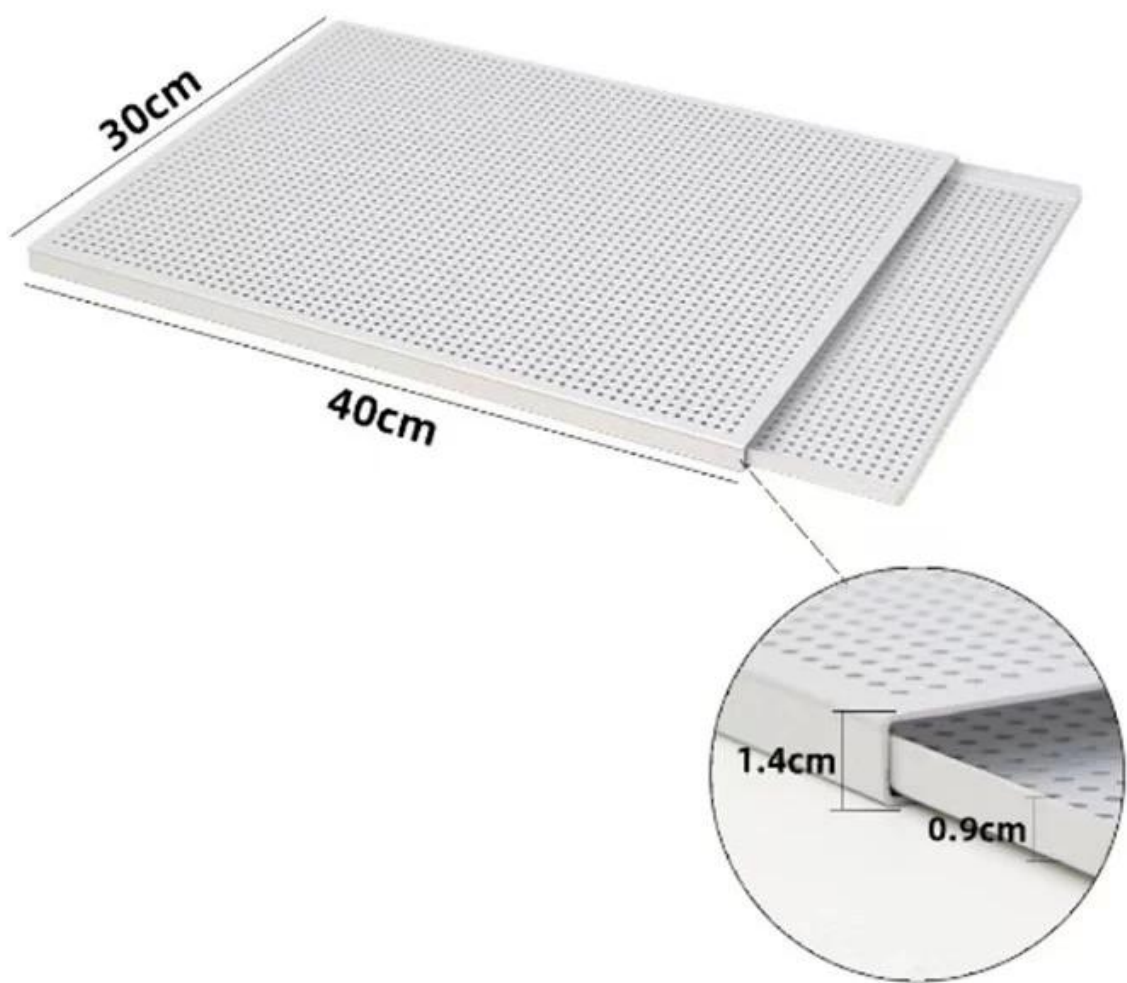





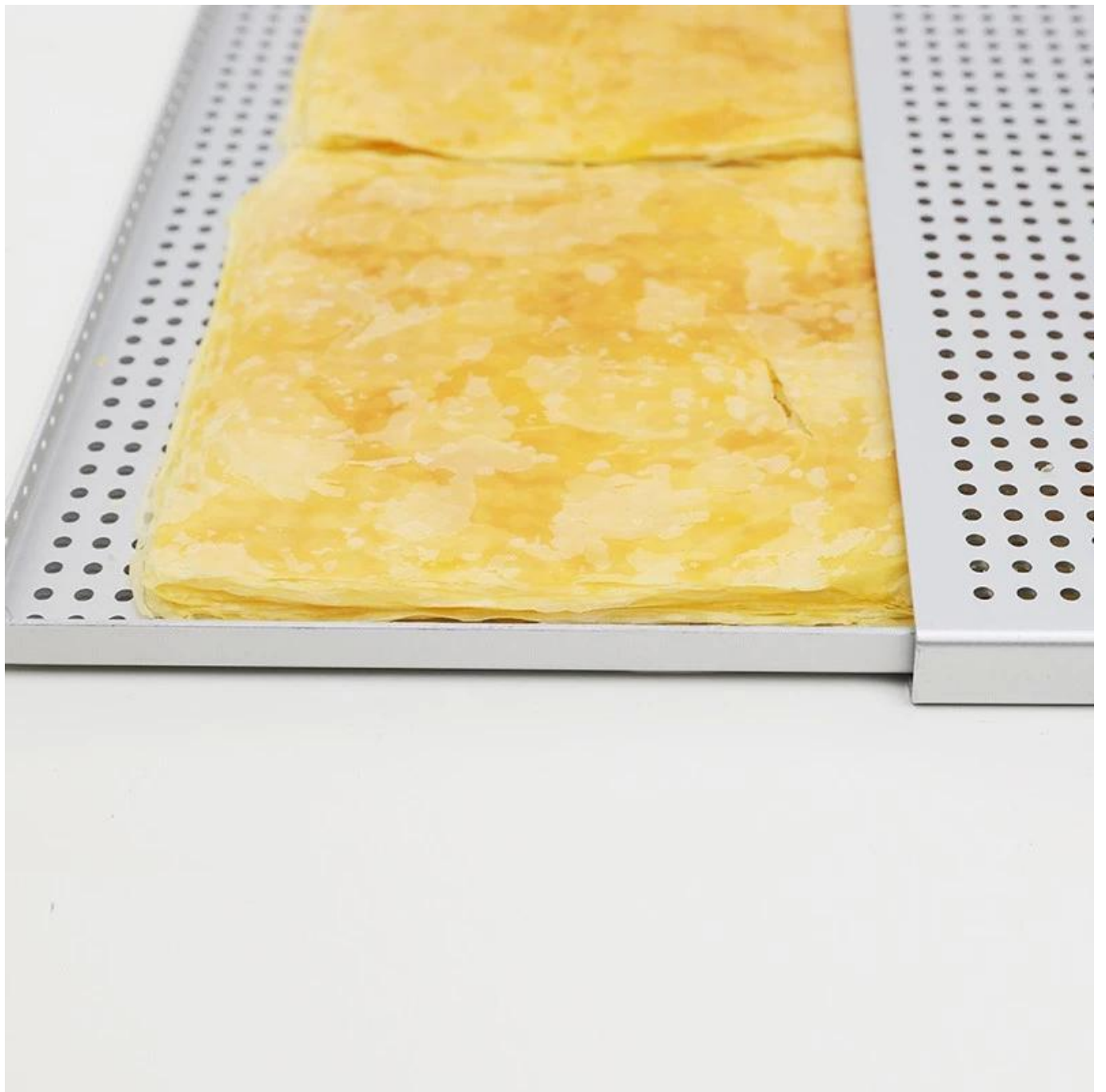

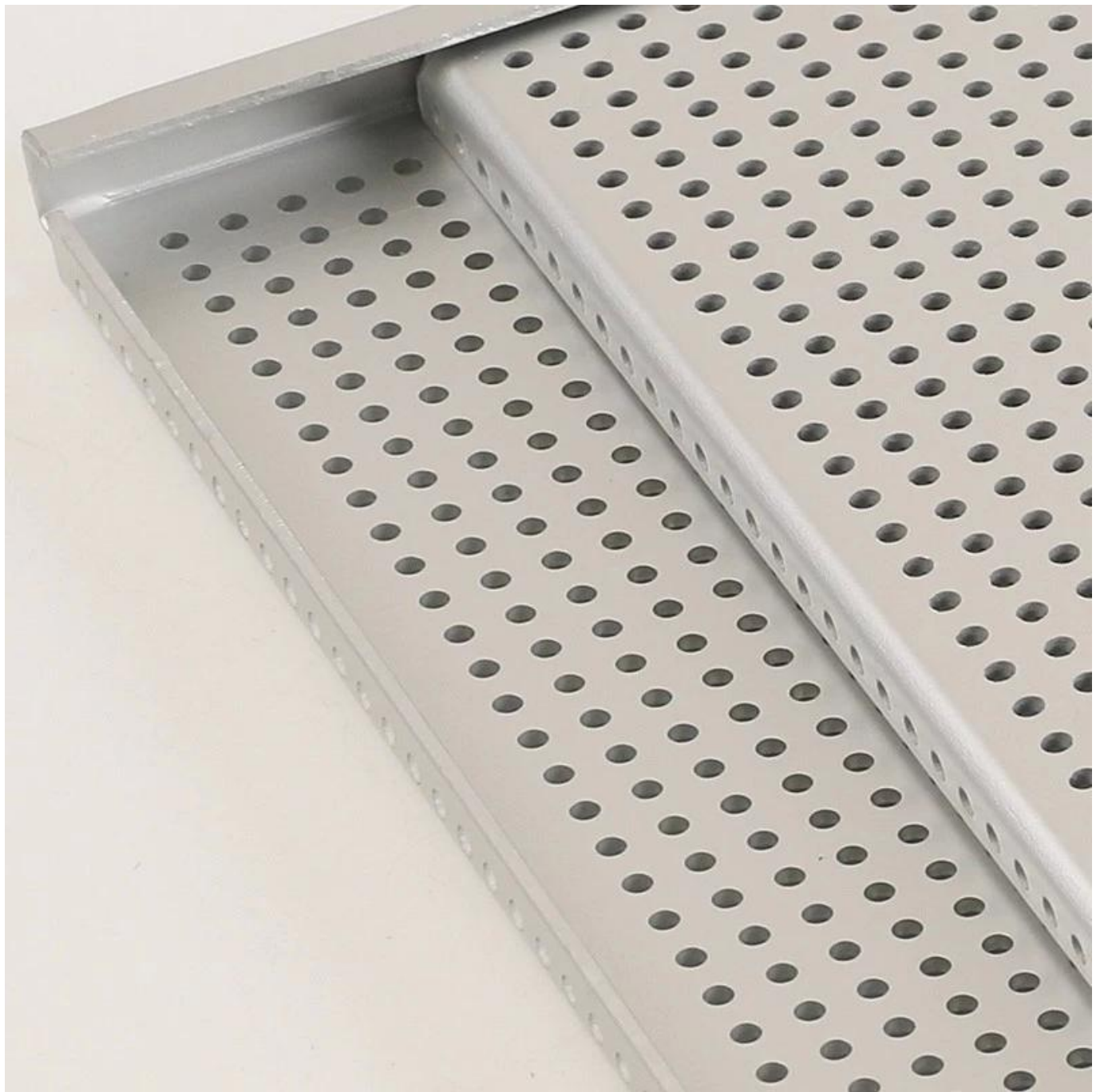

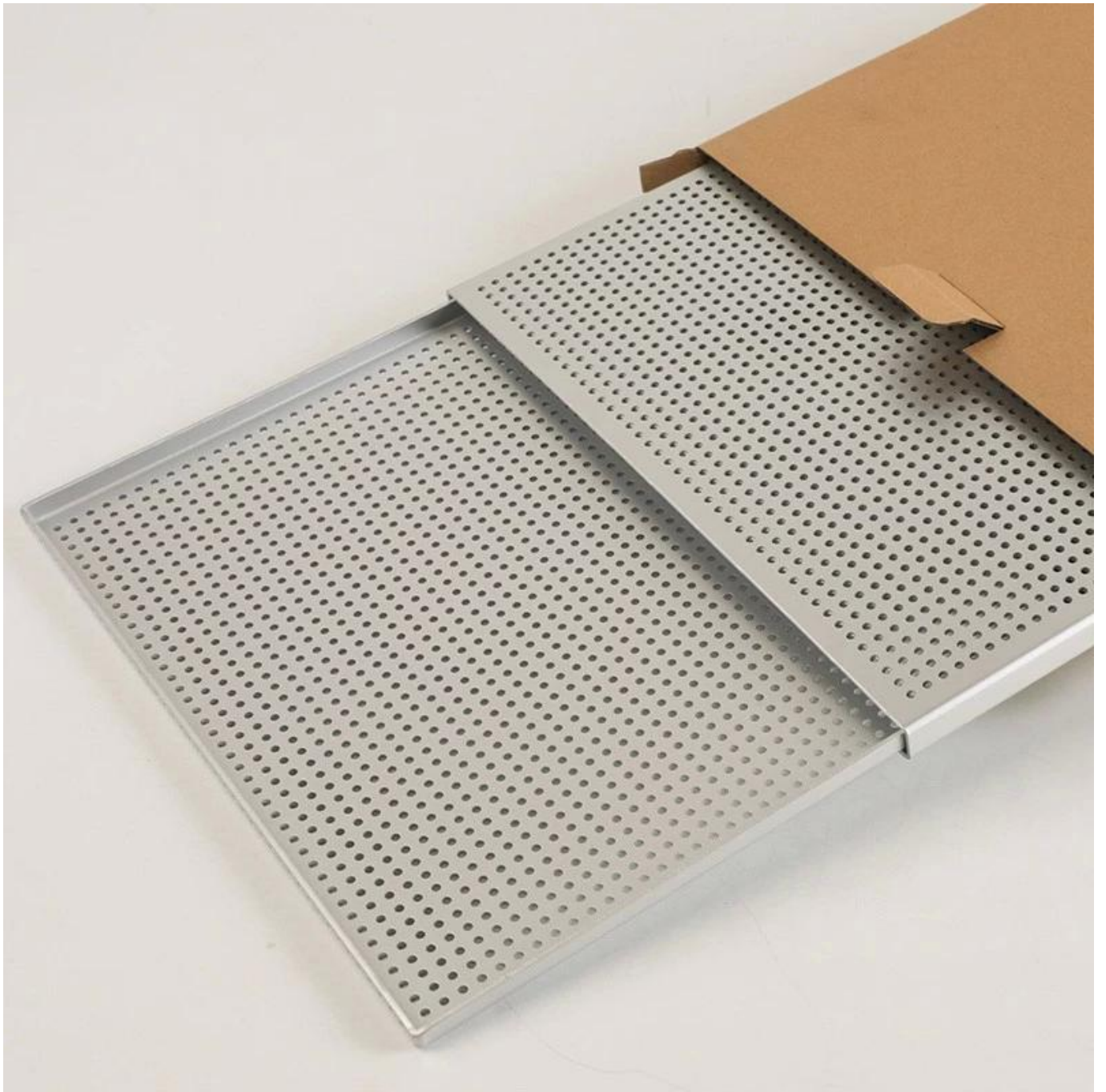



Tsingbuy Commercial Baking Tray Factory

Tsingbuy [China aluminum baking pans manufacturer](#) gumagawa ng mga pan sambahayan at komersyal na sheet para sa pakyawan at pag-export na may maraming karanasan. Nakakatulong ito kahit na magpainit mula sa sulok hanggang sa sulok at maghurno ng mga batch sa mas kaunting oras. Ang mas maliit na baking sheet na ito ay perpekto para sa mga appetizer at angkop para sa karamihan ng mga oven ng toaster. Ang mga sukat ng oven tray ay 17x13 pulgada.

Maaari mong i-customize ang mga sheet pans na may maraming mga opsyon sa materyal, laki, uri, surface finish at iba pa. Sabihin sa amin ang iyong mga kinakailangang detalye at makakagawa kami ng sheet pan na tumutugon sa iyong mga pangangailangan.

Higit pang mga sheet pan mula sa Tsingbuy para sa iyong sanggunian bilang sumusunod.

Integrated Machine Stamped Sheet Pans



wire rim



corrugated



perforated



nonstick



perforated



with bars



no wire rim



nonstick



right angel



nonstick



gold color



stainless steel

Handmade Sheet Pans



400*720mm



U-shaped



Square



nonstick

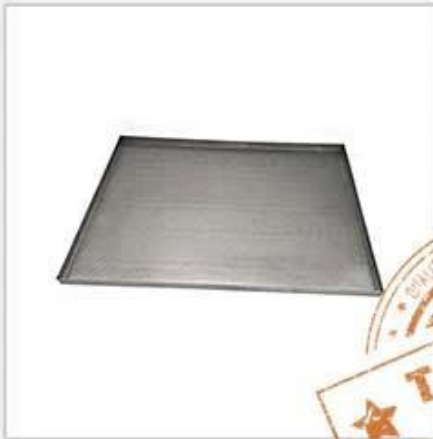

600*800mm



inclined edge

More Custom Baking Trays



sheet pan with lid

flat baking sheet

perforated tray with lid





Our Sheet Pan Workshop ODM & OEM Service

Well equipped with CNC machines, punching, cutting, moulding machines, our annual production ability has been over 150million US-dollars



Bukod sa [pakyawan Aluminum baking sheet sa China](#), Nagbibigay ang Tsingbuy ng custom na disenyo at paggawa ng mas maraming bakery bakeware para sa komersyal na paggamit, tulad ng French bread baguette pan, strap loaf pan, multi-mould cupcake baking pan, bakery trolley atbp. Maligayang pagdating upang makipag-ugnayan sa amin anumang oras kung ikaw ay nasa merkado para sa mga baking pan.

MAIN PRODUCT

● Industry cup tray



● Baguette tray



● Sheet pan



● Bakery Trolley



● Bread pan set

