

# Factory ODM&OEM Bakeware, Aluminum Metal Non Stick Fluted Pullman Bread Loaf pan Toast Sandwich Bread Baking Tin Mould na may Takip

## **Pangunahing tampok ng double sided teflon non stick fluted loaf bread baking pan na may takip**

1. **Premium na Materyal na Aluminum:** Ginawa mula sa mataas na kalidad na aluminyo, ang aming loaf bread baking pan ay idinisenyo upang magbigay ng pantay na pamamahagi ng init, na tinitiyak na ang iyong tinapay ay nagluluto sa bawat oras.

2. **Double-Sided Teflon Non-Stick Coating na may Corrugated Surface:** Magpaalam sa pagdikit at pagpunit gamit ang aming double-sided Teflon non-stick coating. Ang corrugated surface (fluted surface) ay hindi lamang pumipigil sa iyong tinapay na dumikit ngunit nagbibigay din ng isang kaakit-akit na texture sa iyong mga tinapay, na ginagawa itong isang piging para sa mga mata pati na rin ang lasa.

3. **Maramihang Mga Karaniwang Laki at Custom na Opsyon:** Propesyonal na panadero ka man o mahilig sa bahay, sinasagot ka namin. Pumili mula sa aming hanay ng mga karaniwang laki, o mag-opt para sa isang custom na laki upang umangkop sa iyong mga partikular na pangangailangan. Naniniwala kami sa kakayahang umangkop upang matugunan ang iyong mga natatanging pangangailangan.

4. **Commercial-Grade Durability:** Binuo upang matiis ang kahirapan ng isang panaderya, restaurant, o pabrika ng pagkain, ang aming bread loaf baking pan ay commercial-grade at kayang tiisin ang mabigat na paggamit. Gayunpaman, ito ay hindi lamang para sa mga pro – ito rin ang pinakamahusay na kalidad na pagpipilian para sa iyong kusina sa bahay, na tinitiyak na ang iyong lutong bahay na tinapay ay magiging kasing ganda ng anumang panaderya.

5. **Ipinagmamalaki na Ginawa ng mga Propesyonal sa China:** Si Tsingbuy ay isang [komersyal na pullman loaf pan manufacturer](#) nakabase sa China na may higit sa 15 taong karanasan at pinagkakatiwalaan ng mga tapat na customer mula sa 180 na bansa. Ang aming Loaf Pan ay isang cornerstone na produkto sa aming hanay. Kapag pinili mo ang aming kawali, hindi ka lang pumipili ng produkto; pumipili ka ng kasosyo sa tagumpay sa pagluluto. Umasa sa amin na tulungan kang maging mahusay sa iyong lokal na merkado at itaas ang iyong baking game.

## **Mga larawan ng produkto ng double sided teflon non stick fluted loaf bread baking pan na may takip**



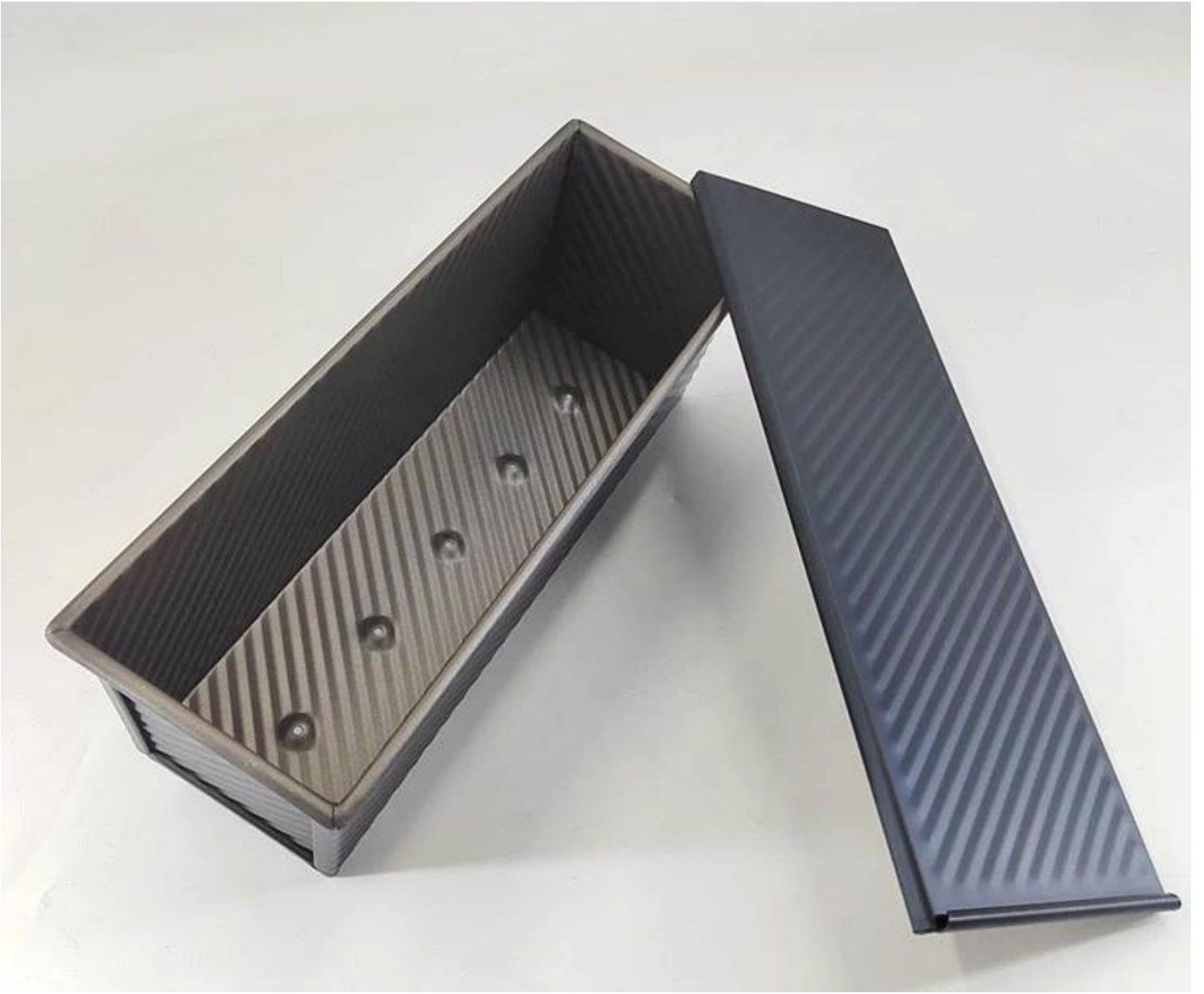







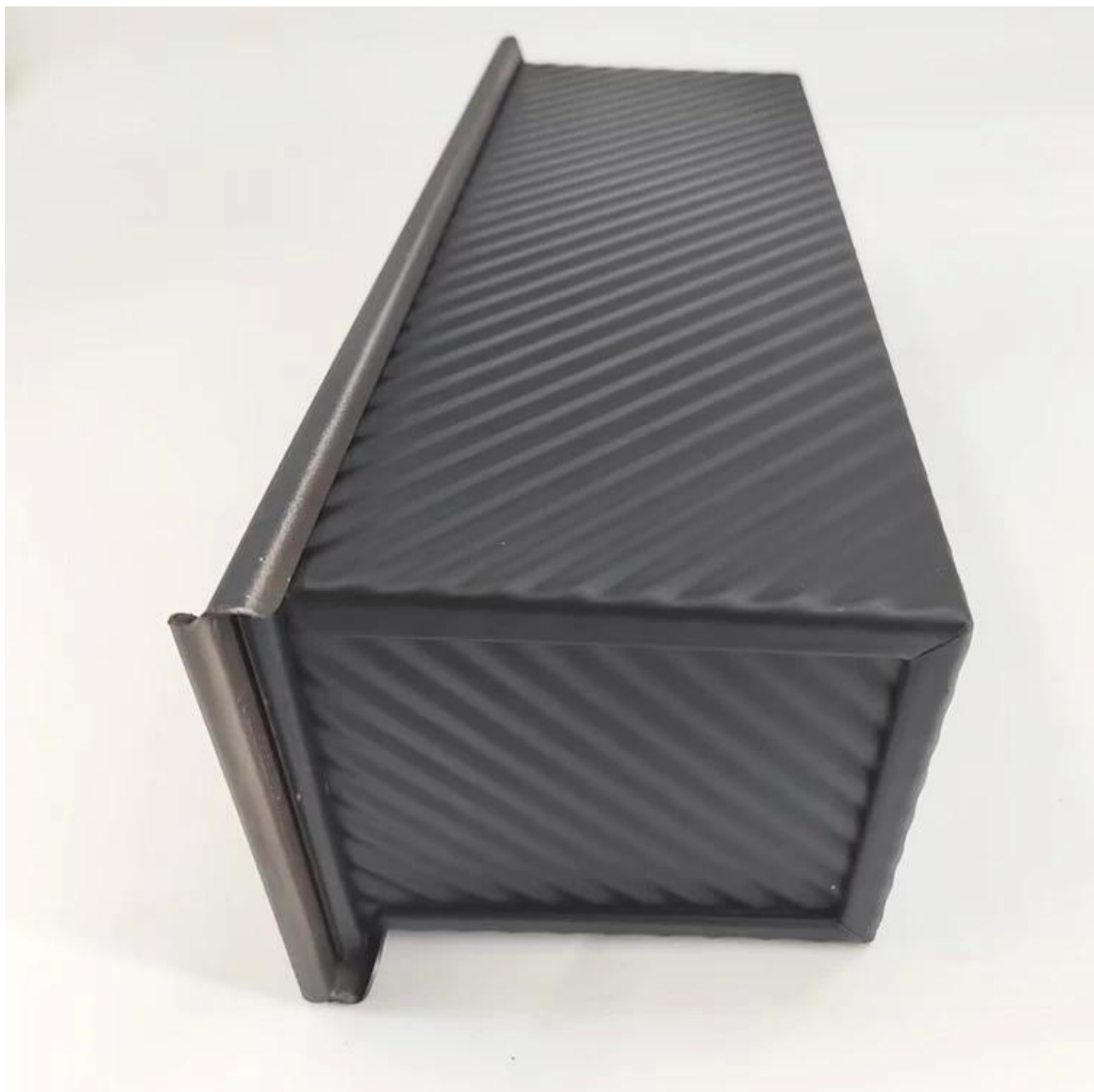





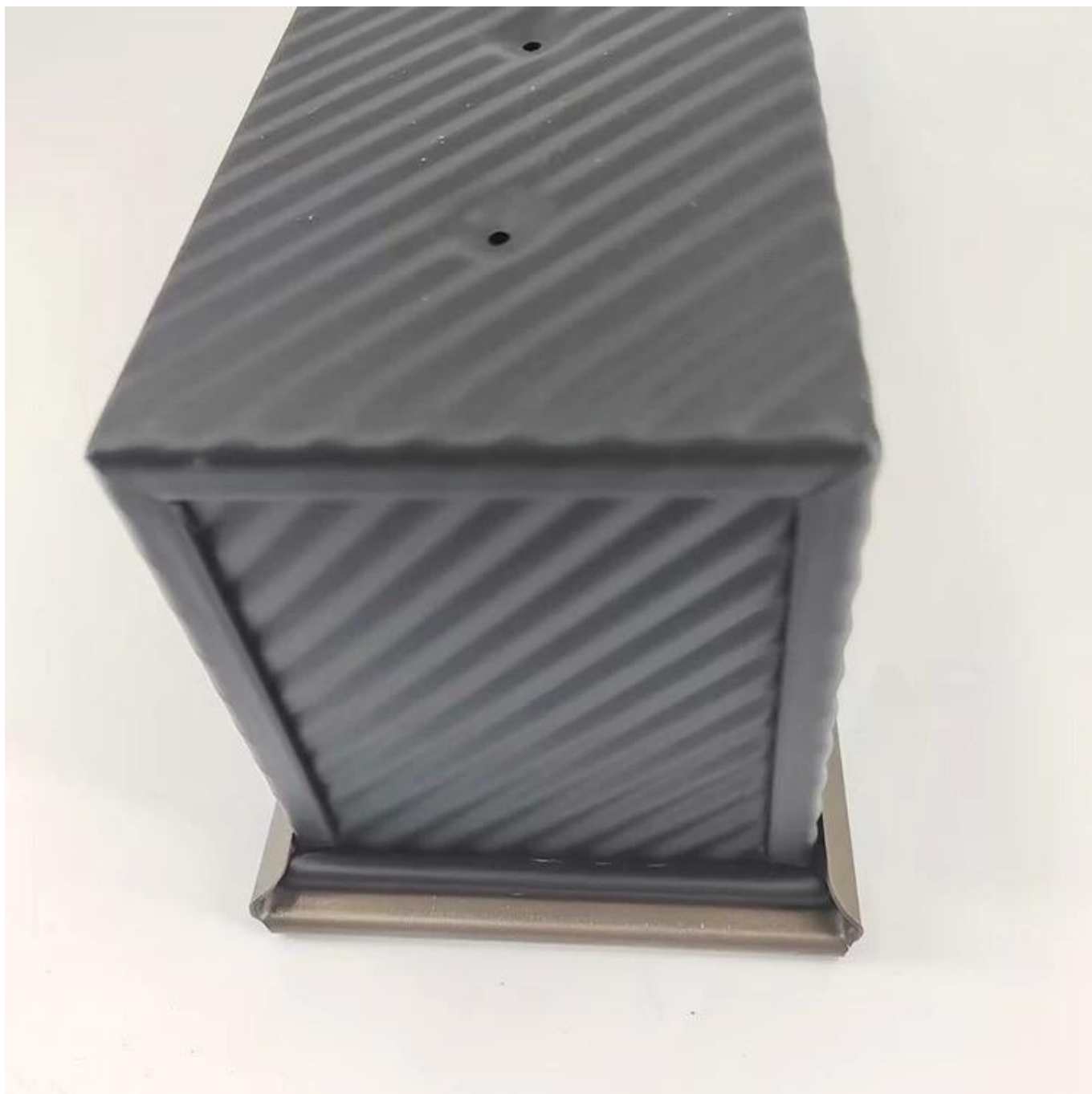

## Higit pang uri ng tinapay at kawali para sa iyong impormasyon

Narito ang higit pa [pakyawan na aluminyo na mga kawali](#) para sa parehong panaderya at gamit sa kusina sa bahay.

Ang aming pullman loaf pans ay idinisenyo sa simpleng istilo, maganda at practica kasama ko mabilis na pagpapadaloy ng init, kahit na pag-init, hindi madaling lumitaw bahagyang pagkapaso.

Opsyonal na materyal: aluminyo, aluminized na bakal, hindi kinakalawang na asero

Mga opsyon sa pagbubutas: walang butas, butas sa ilalim, butas-butis

Gamit ang eksena: single loaf pan, strap loaf pan

Mga opsyon sa ibabaw: makinis, corrugated, walang patong, Teflon non-stick, silicone non-stick

Sukat: anumang laki

Takip: may takip o hindi bilang iyong kinakailangan.

# customized single loaf pan





Material:

Aluminum alloy

Aluminized steel

Custom Ang paggawa ng strap loaf pan ay isa sa aming pinakamalaking lakas, maligayang pagdating para sa karagdagang impormasyon.

Tsingbuy [supplier ng non stick loaf pan](#) ay nakikibahagi sa paggawa ng bakeware sa loob ng mahigit 12 taon at nagsusuplay ng libu-libong bakeware para sa mga internasyonal na customer. Gamit ang aming baking pan , madali kang makakagawa ng lahat ng uri ng masasarap na pagkain, Chiffon mga cake, mousse cake, Pound cake, cheese cake, atbp

## More Customized Strap Loaf Pans from Tsingbuy



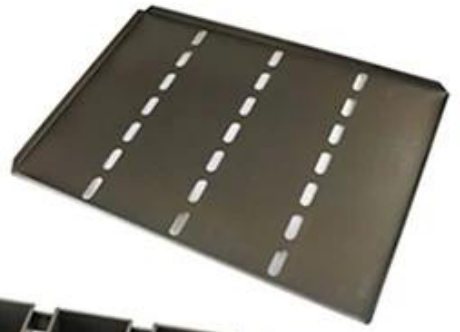



Customized shape  
Customized size  
Rack matched

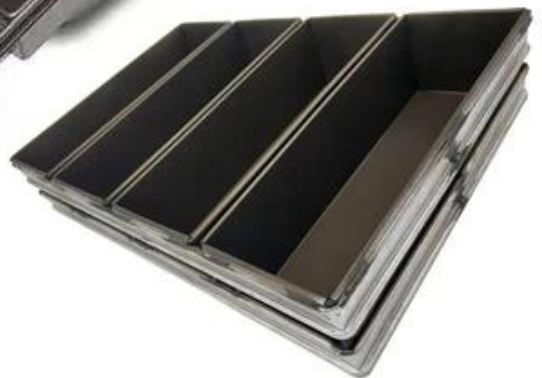

## Customized Single Loaf Pan

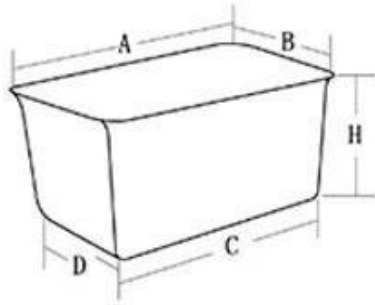

- A.Top length of the item
- B.Top width of the item
- C.Bottom length of the item
- D.Bottom width of the item
- H.Height

## Customized Strapped Loaf Pan Sets

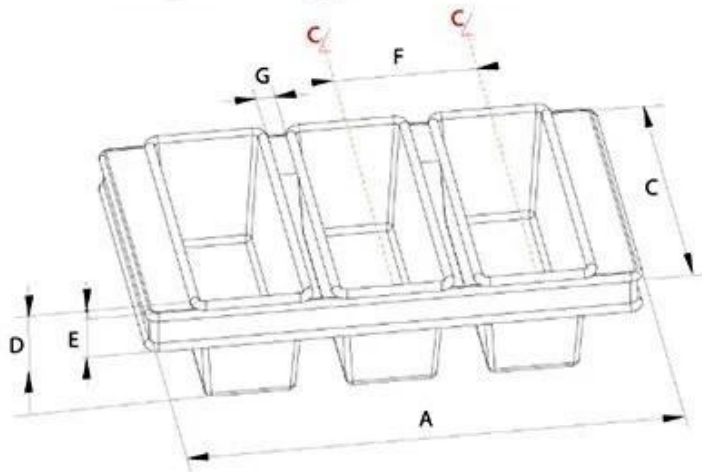

- A.Overall Length
- C.Overall Width
- D.Depth
- E.Frame Height
- F.Center-to-center
- G.Pan Distance



Flat handle



Frame handle



no handle



Matching lid (Drop Style)

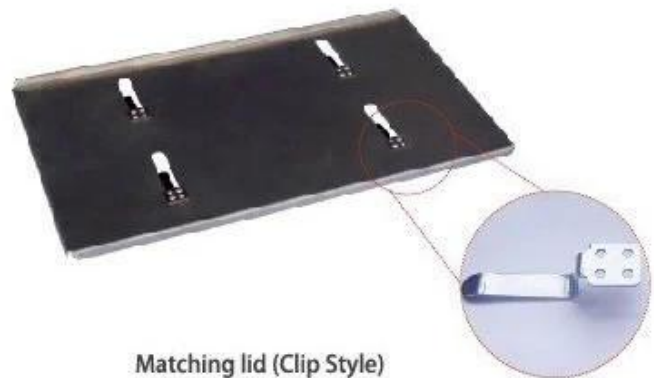

Matching lid (Clip Style)

## Tsingbuy loaf & bread pan factory pictures

## Pictures of Workshop











