

Custom Made Industrial Use Aluminized bakal Non Stick 10-Cavities Strap Loaf Pan Toast Sandwich Bread Baking Tin Mould Set

Pangunahing tampok ng custom made aluminized steel 10-cavities non stick strap loaf bread baking pan set

1. Ang komersyal na bread baking pan na ito ay may kakayahang maghawak ng (10) mga tinapay, bawat kahon ay may sukat na 165x80mm. Ang produktong ito ay nagpapahintulot sa iyo na makagawa ng sampung tinapay upang maibenta o maihain nang mabilis habang pinapanatili pa rin ang kalidad ng pagluluto. Kung kailangan mong gawin ang iyong mga signature na dinner loaves o seasonal na tinapay, ang bread pan na ito ay isang magandang pagpipilian upang tulungan kang matapos ang iyong baking job nang madali.
2. Ang mga bread loaf pan ay ginawa mula sa 0.7/1.0/1.2mm aluminized steel na may dobleng nakatiklop na sulok, Ang gilid ng e ach pan ay nilagyan ng 5mm diameter rim wire. Ang mga frame ay ginawa ng 1.2mm aluminized steel para sa sobrang suporta at tibay. Ang ibabaw ng mga kawali ng tinapay ay fluted finish at may mga steam hole. Hindi angkop para sa gluten-free mixtures.
3. Itong strap na tinapay Ang loaf pan ay ginawa sa Tsina [tagagawa ng malalaking tinapay](#) - Tsingbuy Industry Limited. Ito ay magagamit sa isang hanay ng mga laki, sa iba't ibang mga configuration upang umangkop sa lahat ng pang-industriya, komersyal o domestic oven.

Mga larawan ng produkto ng custom made aluminized steel 10-cavities non stick strap loaf bread baking pan set







3 pcs



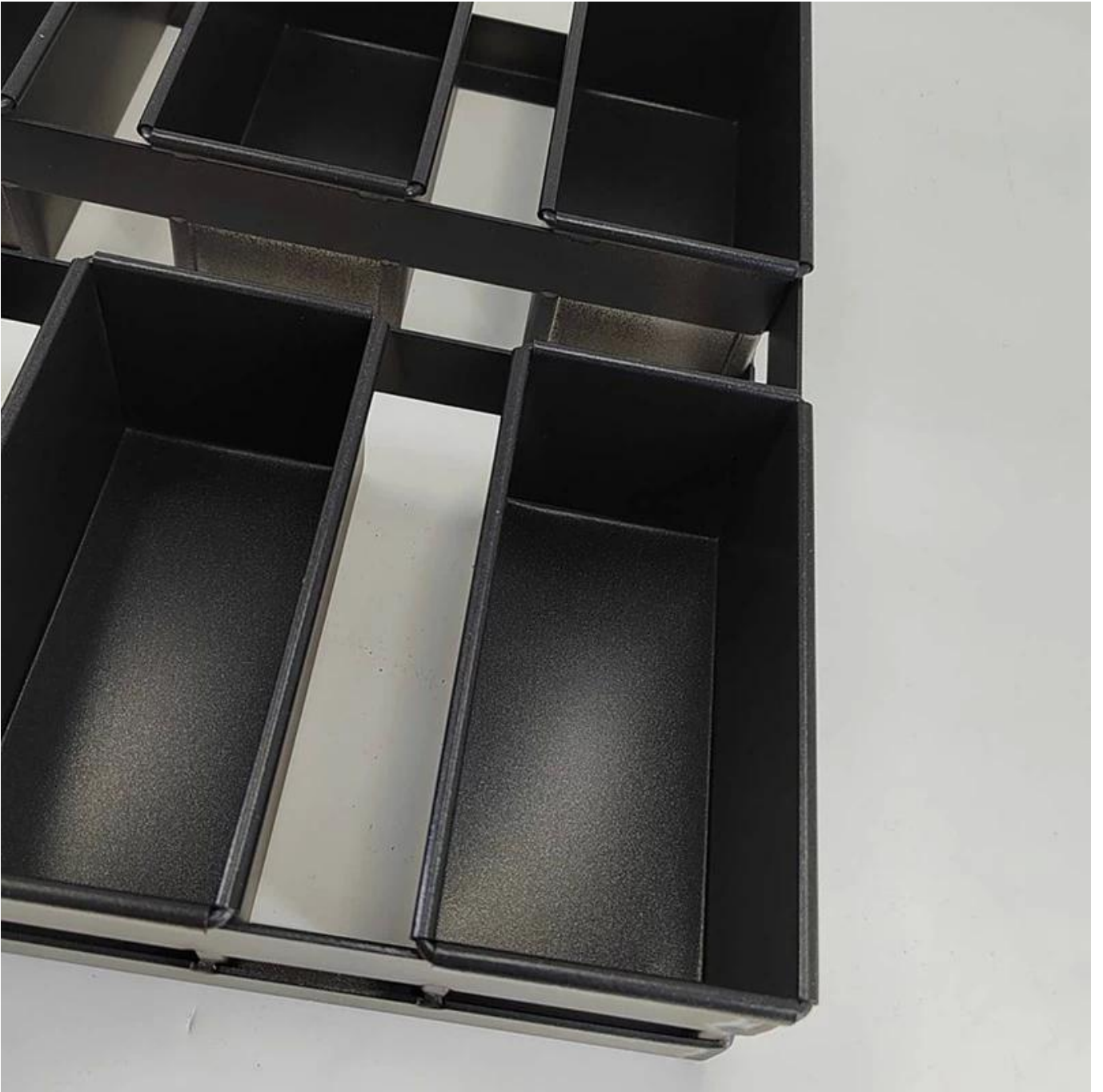



Tsingbuy is propesyonal sa paggawa pareho walang asawa tinapay pan at strap tinapay mga kawali. Dito tayo ibahagi ilang modelo ng strap loaf pan para sa iyong sanggunian. Karamihan sa mga strap loaf pan ay pasadyang idinisenyo ayon sa mga kinakailangan.

More Customized Strap Loaf Pans from Tsingbuy



Customized Single Loaf Pan

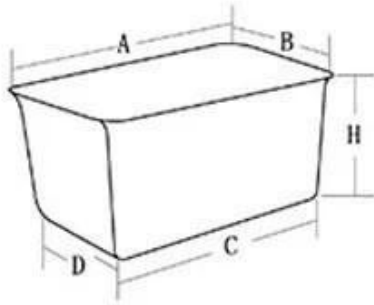

- A. Top length of the item
- B. Top width of the item
- C. Bottom length of the item
- D. Bottom width of the item
- H. Height

Customized Strapped Loaf Pan Sets

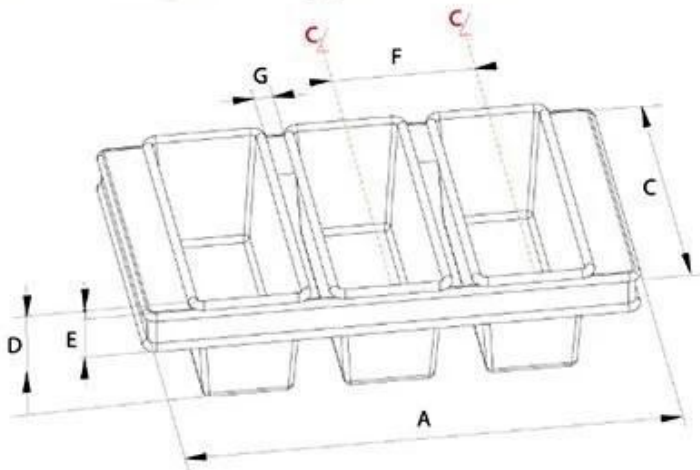

- A. Overall Length
- C. Overall Width
- D. Depth
- E. Frame Height
- F. Center-to-center
- G. Pan Distance



Flat handle



Frame handle



no handle

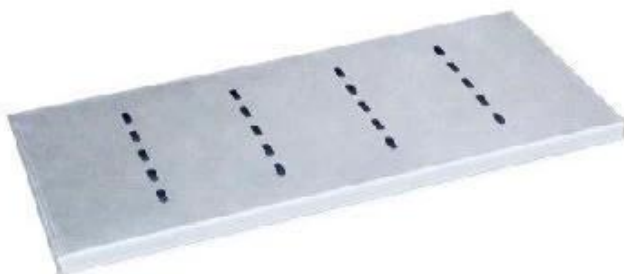

Matching lid (Drop Style)

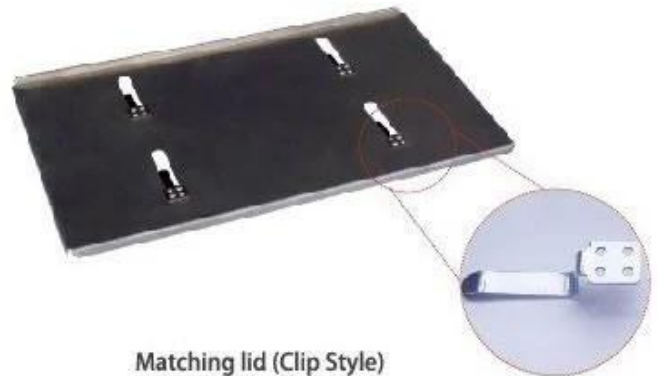

Matching lid (Clip Style)



Customized shape
Customized size
Rack matched

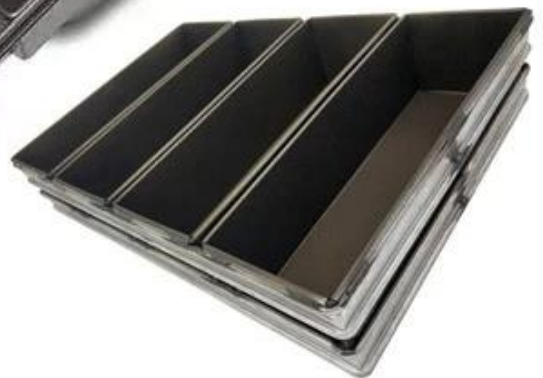

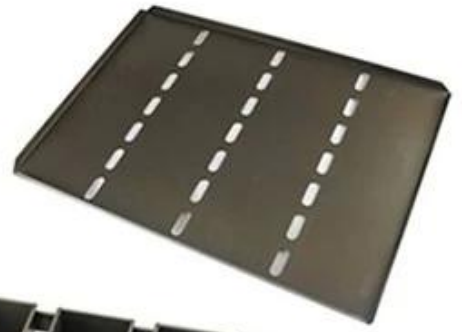

Procedures for custom made loaf baking pans

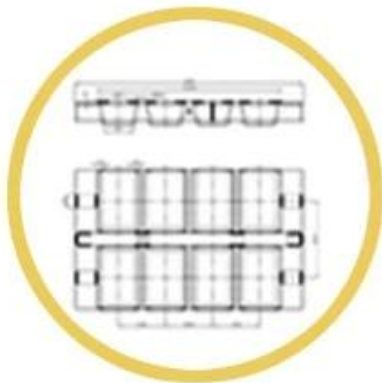

1. DRAWING



2. DESIGN



3. PRODUCT



6. SHIPPING



5. LOADING



4. PACKING



Custom Made Strap Loaf Pan Used with Bakery Trolley



Higit pang mga uri ng single bread loaf baking pan para sa kusina sa bahay, panaderya, restaurant atbp

Narito ang ilang classic modelo ng isang tinapay bread baking pan mula sa Tsingbuy [supplier ng non stick loaf pan](#).

Single Loaf Pan



natural surface



corrugated



full perforation



nonstick



corrugated



golden color



holes at bottom



full perforation



custom size



Mga factory na larawan mula sa Tsingbuy strap loaf pan producer





Bukod sa [bread loaf pan pakyawan](#), Ang tagagawa ng bakeware ng Tsingbuy ay nagbibigay din ng custom na disenyo at pakyawan ng iba pang komersyal na bakeware, tulad bilang sheet pans, baguette pans, loaf pans, multi-mould baking pans, bakery s trolley. upang kunsulta amin sa anumang oras.

