

## 450g Aluminium Alloy Non Stick Corrugated Nonstick Loaf tinapay Baking pan with Sliding-on-off Covers

### Mga pangunahing tampok ng

#### 450g corrugated nonstick loaf bread pan toast sandwich bread baking mould

1. gawa sa 1.0mm ang kapal aluminyo haluang metal , .
2. Food-safe at corrugated non-stick na ibabaw ay hindi malagkit, madaling i-demoul, madaling linisin
3. dinisenyo may takip, ito ay maginhawa upang gumawa ng American toast na may flat .
4. Ang ilalim na butas ay opsyonal para sa mas mahusay.
5. Ang wire sa rim na disenyo ay ginagawang mas matibay at hindi madaling ma-deform para sa mahabang buhay ng srvice.
6. Maramihang function para sa paggawa ng mga sandwich, toast, tradisyonal na tinapay na tinapay atbp.
7. Available ang ODM at OEM sa Tsingbuy propesyonal [bread pan](#).
8. Ang Tsingbuy ay isang propesyonal na supplier na buong kapurihan na gumawa ng mataas na kalidad na mga baking tray, pullman loaf tin at nagbigay ng Custom na bakeware para sa internasyonal na merkado sa loob ng mahigit 12 taon.

### Mga larawan ng produkto ng

#### 450g aluminium bread pan pullman loaf pan with cover

## 450G Aluminum Pullpan Loaf Pan Black/Golden Corrugated Nonstick



# Product Specification

---

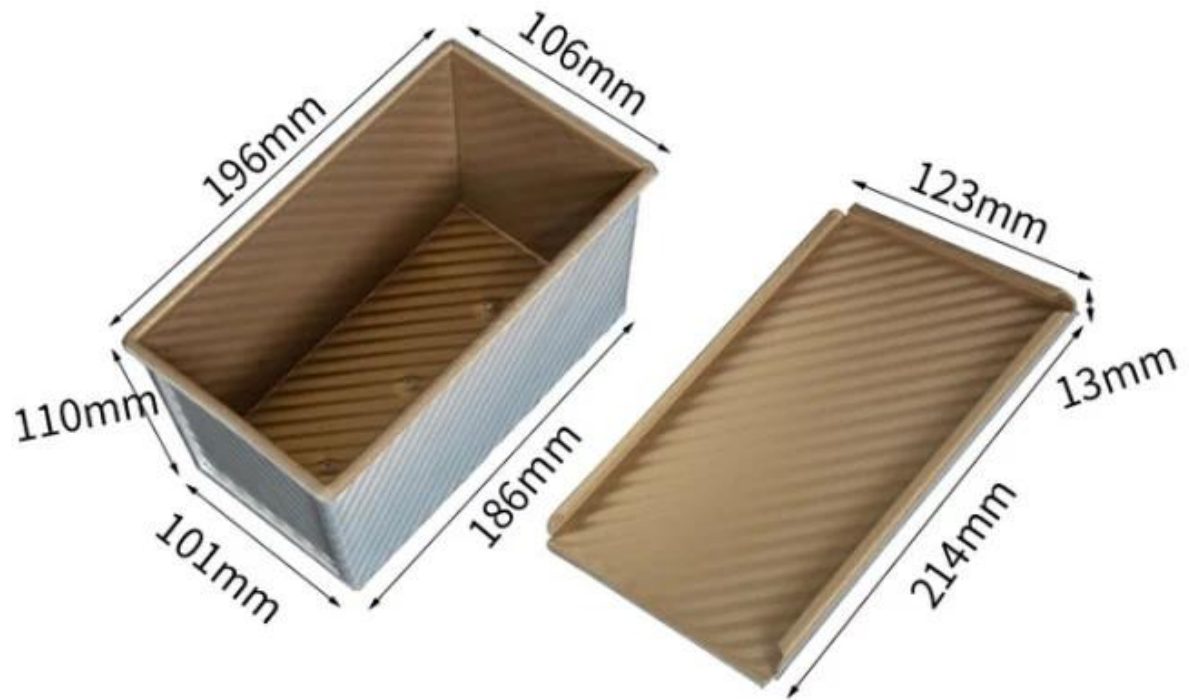

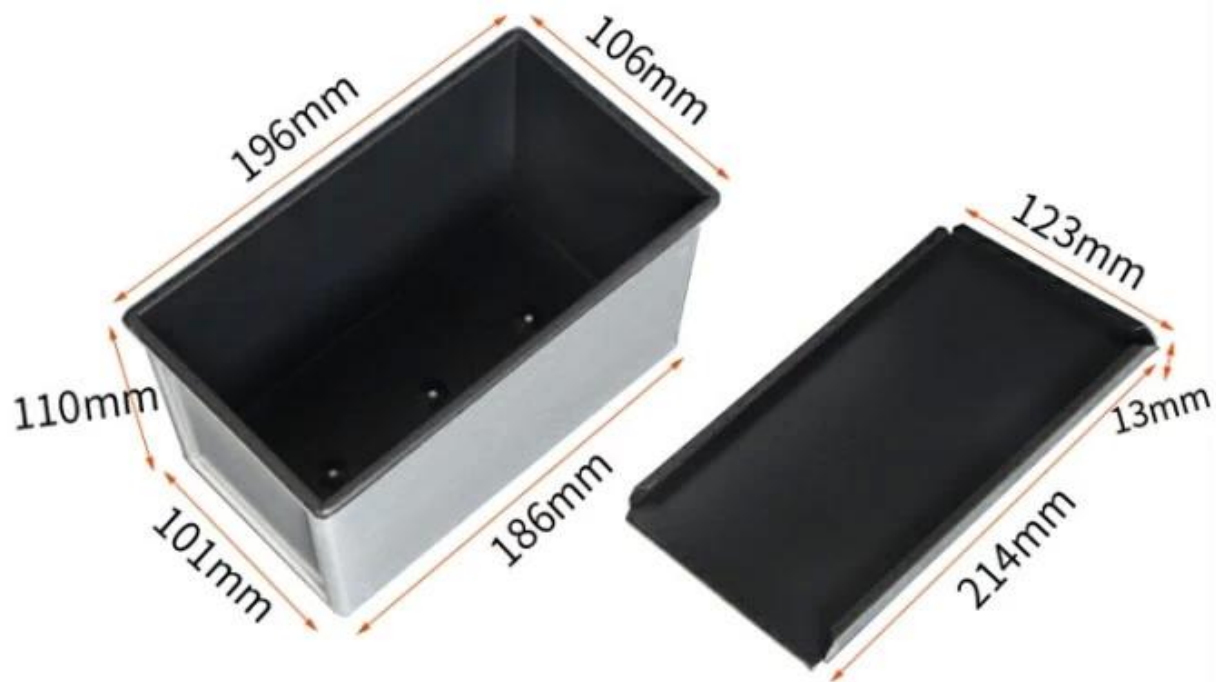

450g Black Nonstick  
corrugated surface





Good Heat Conductivity, baking evenly



Holes at the bottom for better baking effect



## Loaf Pans in Application









Rolled edge with reinforced wire

## Higit pang mga uri ng tinapay at tinapay na kawali para sa iyong impormasyon

Narito ang higit pang mga disenyo para sa [loaf pan pakyawan](#).

Ang aming Pullman loaf pans ay dinisenyo na may simple style, maganda at practica kasama ko mabilis na pagpapadaloy ng init, kahit na pag-init, hindi madaling lumitaw bahagyang masunog.

Opsyonal na materyal: aluminyo, aluminized na bakal, hindi kinakalawang na asero

Mga opsyon sa pagbubutas: walang butas, butas sa ilalim, butas-butatas

Gamit ang eksena: single loaf pan, strap loaf pan

Mga opsyon sa ibabaw: makinis, corrugated, walang patong, Teflon non-stick, silicone non-stick

Sukat: anumang laki

Takip: may takip o hindi bilang iyong kinakailangan.

### customized single loaf pan





Custom Ang paggawa ng strap loaf pan ay isa sa aming pinakamalaking lakas, maligayang pagdating para sa karagdagang impormasyon.  
 Kami ay nakikibahagi sa pagmamanupaktura ng bakeware sa loob ng mahigit 12 taon at nagsusuplay ng libu-libong bakeware para sa mga internasyonal na customer. Gamit ang aming baking pan , madali kang makakagawa ng lahat ng uri ng masasarap na pagkain, Chiffon mga cake, mousse cake, Pound cake, cheese cake, atbp

## More Customized Strap Loaf Pans from Tsingbuy



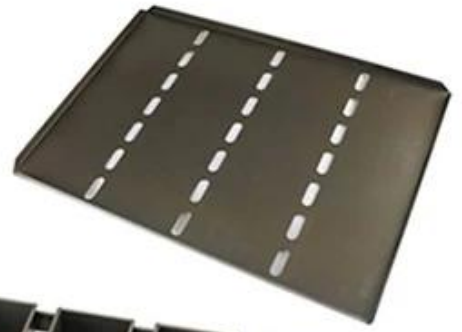



Customized shape  
Customized size  
Rack matched

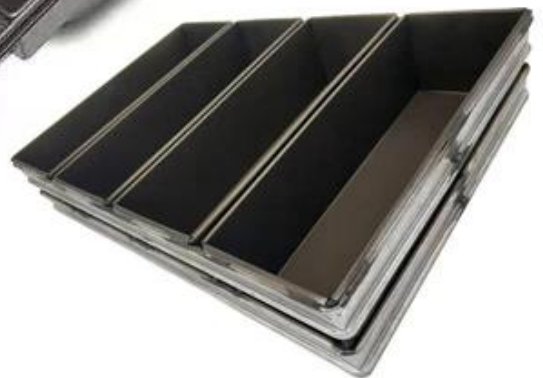

## Customized Single Loaf Pan

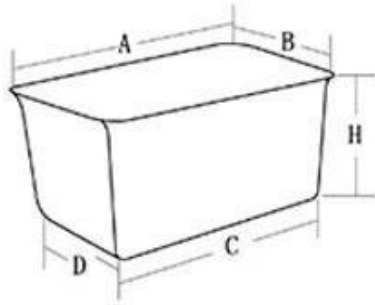

- A.Top length of the item
- B.Top width of the item
- C.Bottom length of the item
- D.Bottom width of the item
- H.Height

## Customized Strapped Loaf Pan Sets

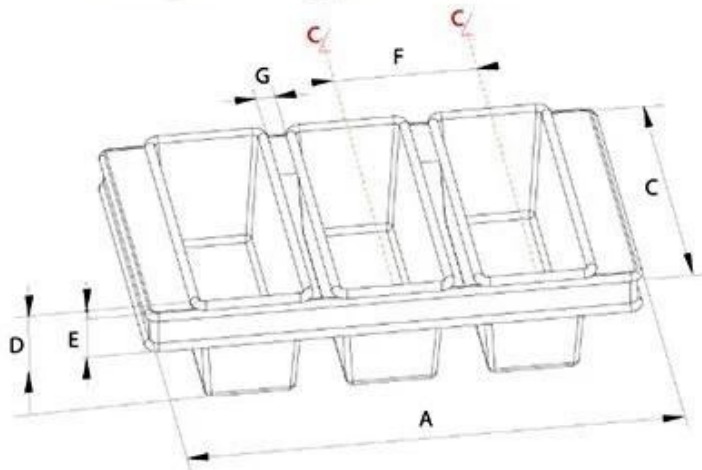

- A.Overall Length
- C.Overall Width
- D.Depth
- E.Frame Height
- F.Center-to-center
- G.Pan Distance



Flat handle



Frame handle



no handle



Matching lid (Drop Style)

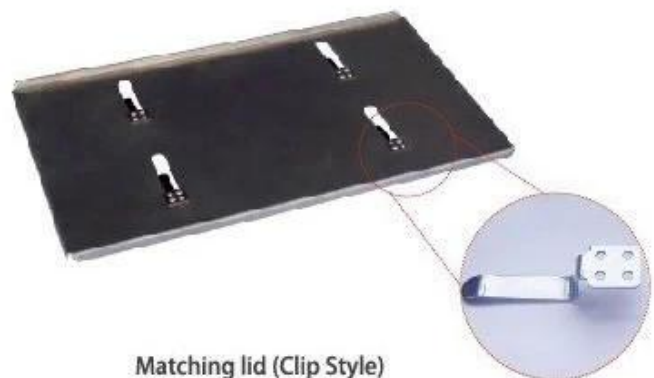

Matching lid (Clip Style)

[Bread & loaf pans](#) mga larawan ng pabrika



## Loaf Pan

Tsingbuy Industry Limited

