

Custom Made Large Size Cavities Non Stick Strap Loaf Pan Toast Bread Mould Sandwich Baking Tin Commercial Baking Pan Set

Pangunahing tampok ng malalaking sukat na cavities strap loaf pan toast bread baking pan set

1. De-kalidad na Konstruksyon: Ang aming loaf pan ay gawa sa matibay na aluminized steel na may top-notch non-stick surface. It's built to last in busy commercial kitchens at madaling linisin.
2. Mahusay na Disenyo: May tatlong cavity at matalinong inilagay na mga butas sa ibaba, tinitiyak ng pan na ito ang pagbe-bake at tinutulungan kang gumawa ng mas maraming tinapay nang sabay-sabay, na nagpapalakas sa iyong produktibidad.
3. Mga Pasadyang Opsyon: Nag-aalok kami ng iba't ibang strap loaf pan upang umangkop sa iyong mga pangangailangan. Kung kailangan mo ng higit pang mga cavity, iba't ibang hugis, o custom na laki, maaari naming tanggapin ang iyong mga kinakailangan.
4. Mahusay sa Makinarya: Ang aming pan ay walang putol na umaangkop sa mga linya ng produksyon ng makinarya, na ginagawa itong perpekto para sa malakihang pagpapatakbo ng pagluluto sa mga panaderya, pabrika ng pagkain atbp.
5. Abot-kayang Kalidad: Tsingbuy [tagagawa ng strap loaf pan](#) ay may higit sa 15 taong karanasan sa komersyal na bakeware, at nagbibigay kami ng mga de-kalidad na produkto sa mapagkumpitensyang presyo. Sumali sa aming mga nasisiyahang customer at itaas ang iyong baking game ngayon!

Mga larawan ng produkto ng non stick large size cavities strap loaf pan toast bread baking pan set













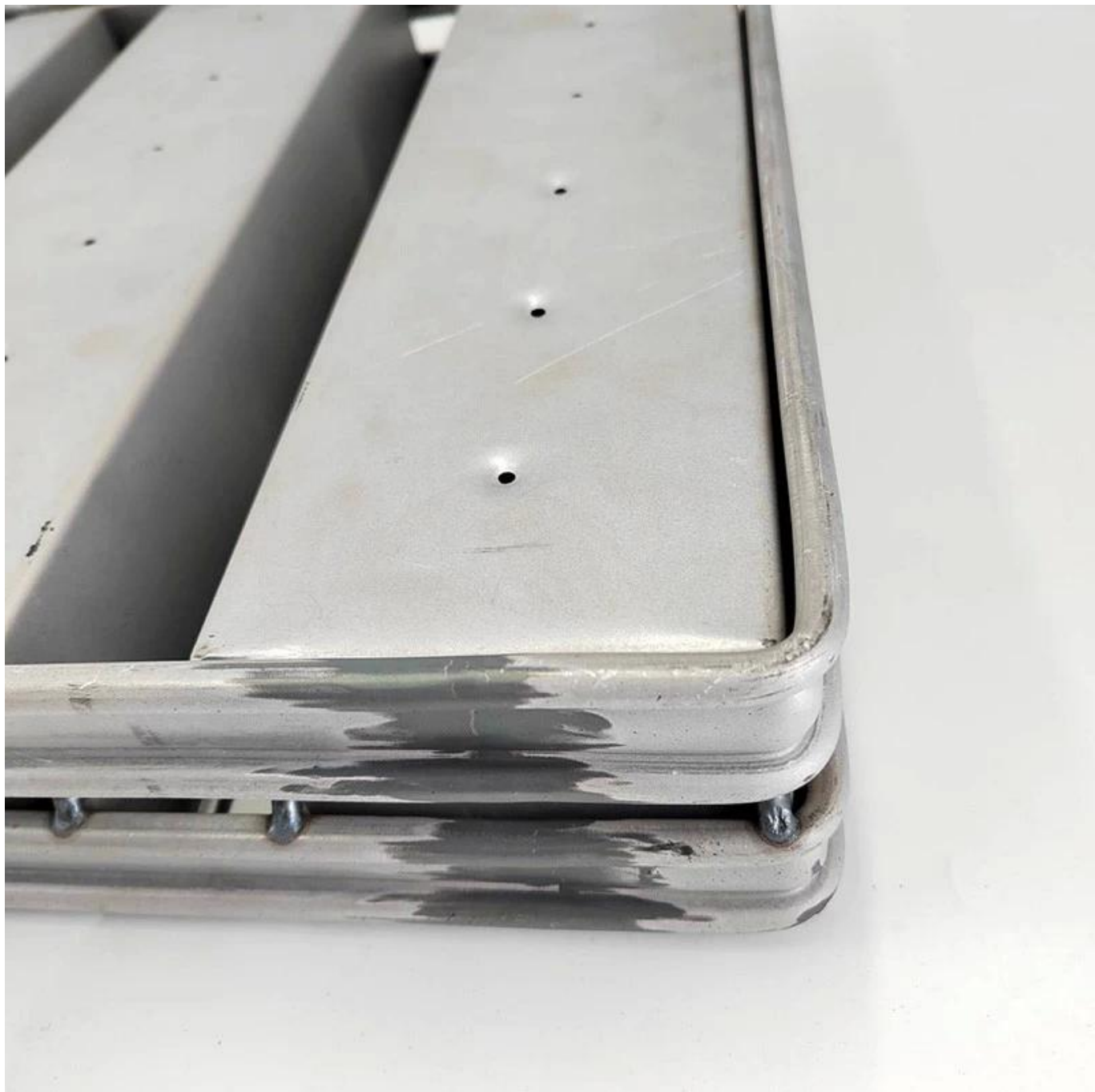



Tsingbuy is propesyonal sa paggawa pareho walang asawa tinapay pan at strap tinapay mga kawali. Dito tayo magbahagi ng ilang modelo ng strap loaf pan para sa iyong sanggunian. Karamihan sa mga strap loaf pan ay pasadyang idinisenyo ayon sa mga kinakailangan.

More Customized Strap Loaf Pans from Tsingbuy



Customized Single Loaf Pan

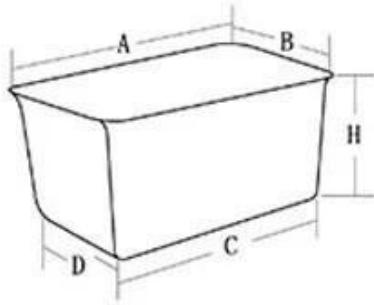

- A. Top length of the item
- B. Top width of the item
- C. Bottom length of the item
- D. Bottom width of the item
- H. Height

Customized Strapped Loaf Pan Sets

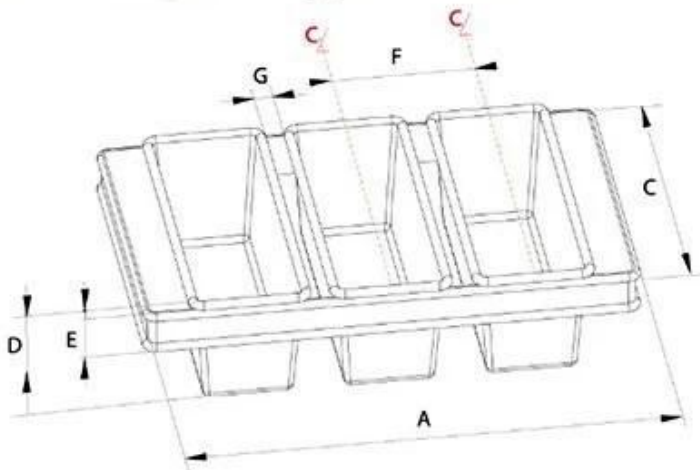

- A. Overall Length
- C. Overall Width
- D. Depth
- E. Frame Height
- F. Center-to-center
- G. Pan Distance



Flat handle



Frame handle



no handle

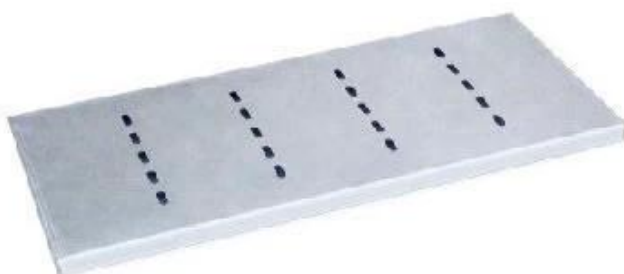

Matching lid (Drop Style)

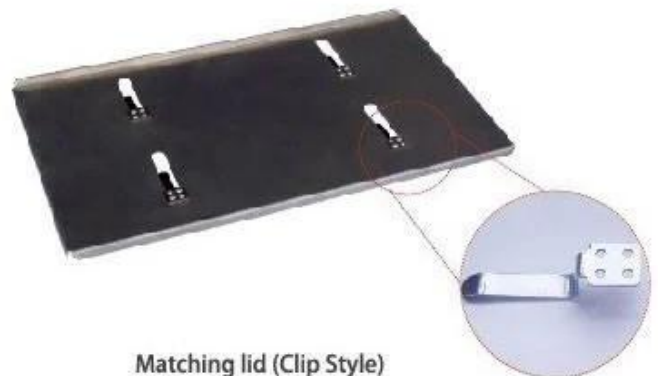

Matching lid (Clip Style)



Customized shape
Customized size
Rack matched

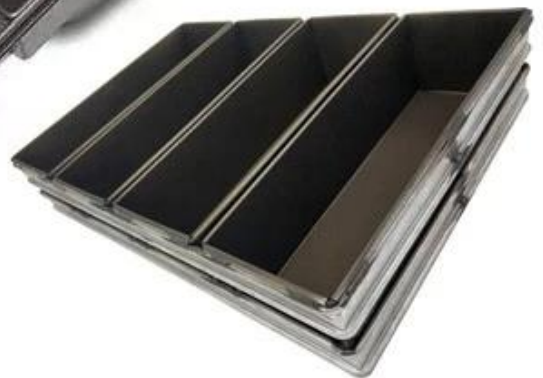

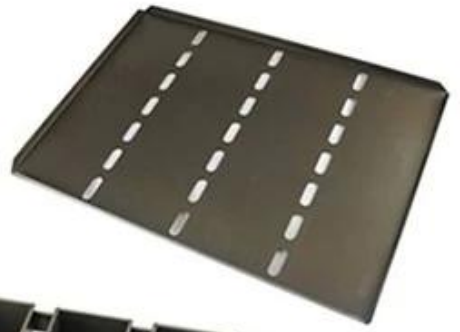

Procedures for custom made loaf baking pans

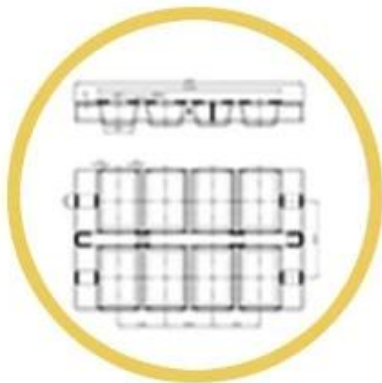

1. DRAWING



2. DESIGN



3. PRODUCT



6. SHIPPING



5. LOADING



4. PACKING



Custom Made Strap Loaf Pan Used with Bakery Trolley



Higit pang mga uri ng single bread loaf baking pan para sa kusina sa bahay, panaderya, restaurant atbp

Narito ang ilang classic modelo ng isang tinapay bread baking pan mula sa Tsingbuy [non stick loaf pan supplier](#).

Single Loaf Pan



natural surface



corrugated



full perforation



nonstick



corrugated



golden color



holes at bottom



full perforation



custom size



Mga factory na larawan mula sa Tsingbuy strap loaf pan producer





Bukod sa [bread loaf pan pakyawan](#), Ang tagagawa ng bakeware ng Tsingbuy ay nagbibigay din ng custom na disenyo at pakyawan ng iba pang komersyal na bakeware, tulad bilang sheet pans, baguette pans, loaf pans, multi-mould baking pans, bakery s trolley. upang kunsulta amin sa anumang oras.

