

# Alusteel

- 1.
- 2.
- 3.
4.  ODM&OEM 15























□□□□□□□□□□□□□□□□□□

customized single loaf pan





Teflon coating

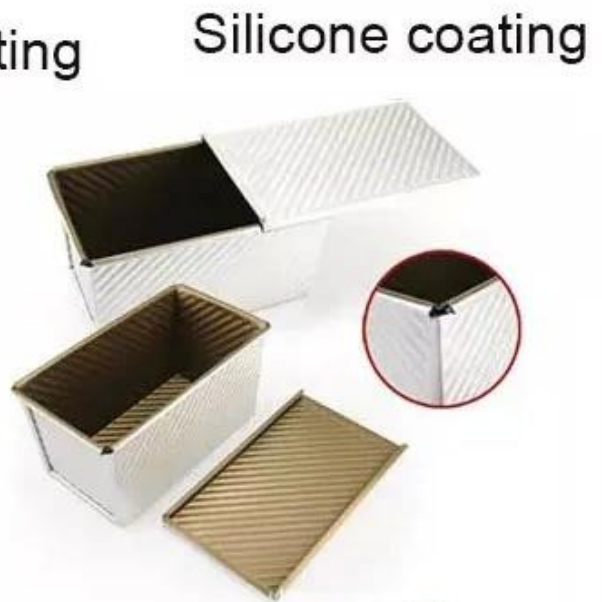

Silicone coating



Material:

Aluminum alloy

Aluminized steel



12 ODM&OEM

12



## More Customized Strap Loaf Pans from Tsingbuy



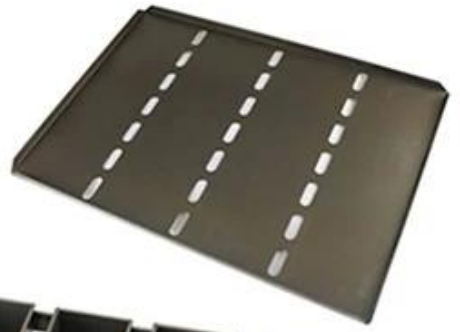



Customized shape  
Customized size  
Rack matched

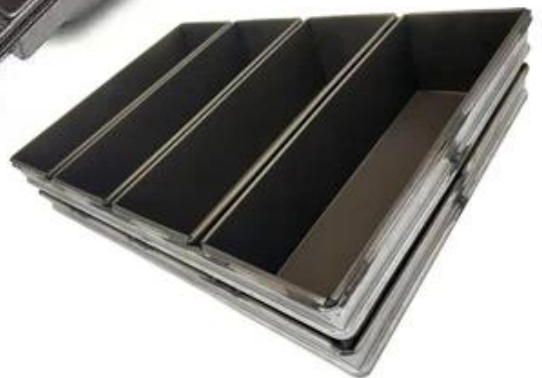



## Customized Single Loaf Pan

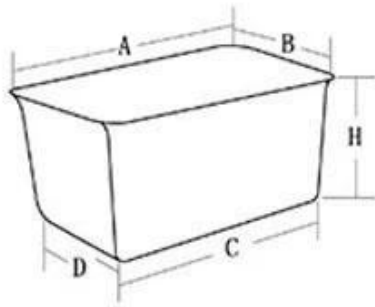

- A. Top length of the item
- B. Top width of the item
- C. Bottom length of the item
- D. Bottom width of the item
- H. Height

## Customized Strapped Loaf Pan Sets

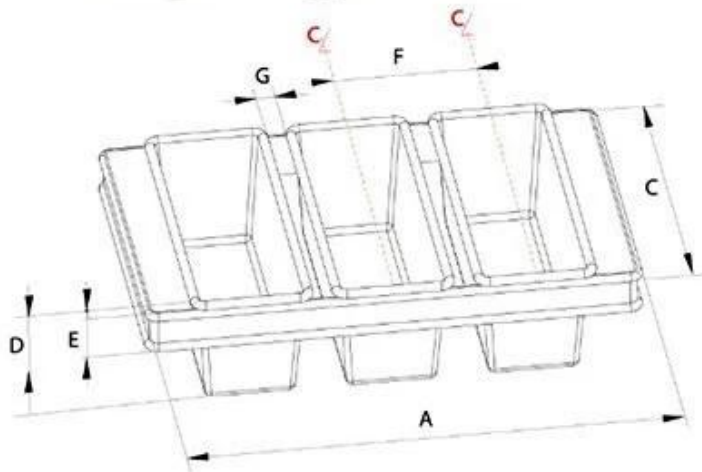

- A. Overall Length
- C. Overall Width
- D. Depth
- E. Frame Height
- F. Center-to-center
- G. Pan Distance



Flat handle



Frame handle



no handle

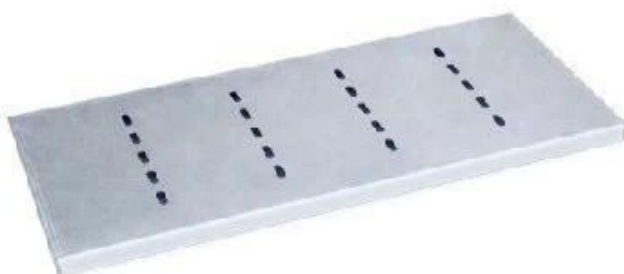

Matching lid (Drop Style)

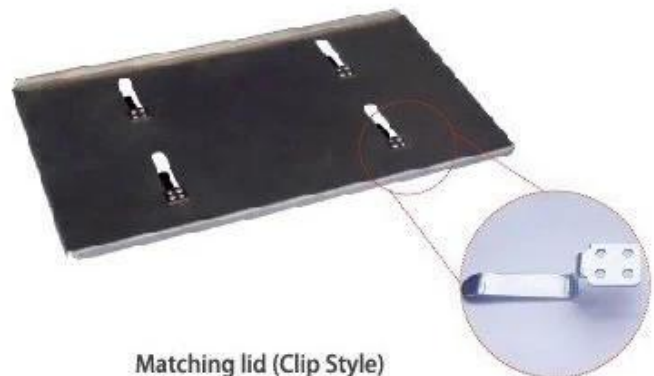

Matching lid (Clip Style)



