

10

10

1 165x80mm (10) 10

2 07/10/12mm e 5mm 12mm

3

10









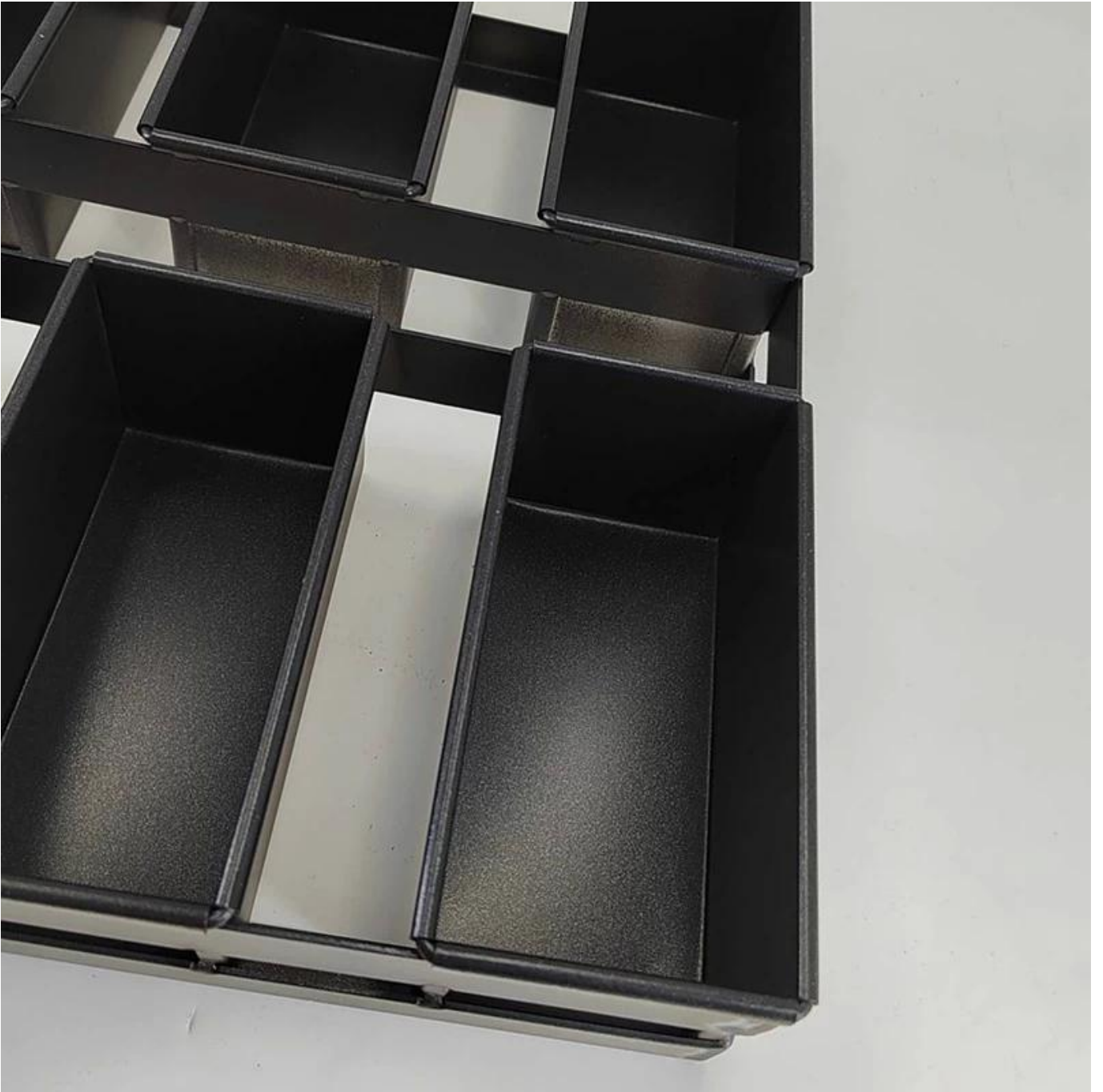

More Customized Strap Loaf Pans from Tsingbuy



Customized Single Loaf Pan

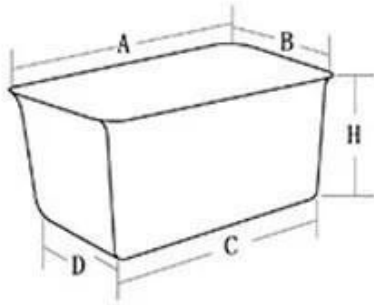

- A. Top length of the item
- B. Top width of the item
- C. Bottom length of the item
- D. Bottom width of the item
- H. Height

Customized Strapped Loaf Pan Sets

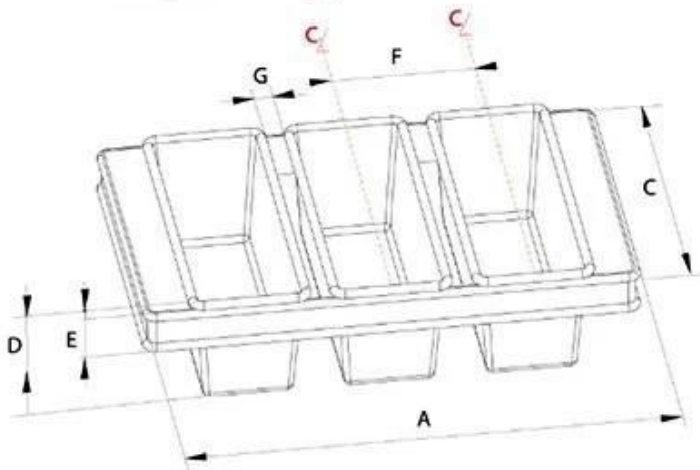

- A. Overall Length
- C. Overall Width
- D. Depth
- E. Frame Height
- F. Center-to-center
- G. Pan Distance



Flat handle



Frame handle



no handle



Matching lid (Drop Style)

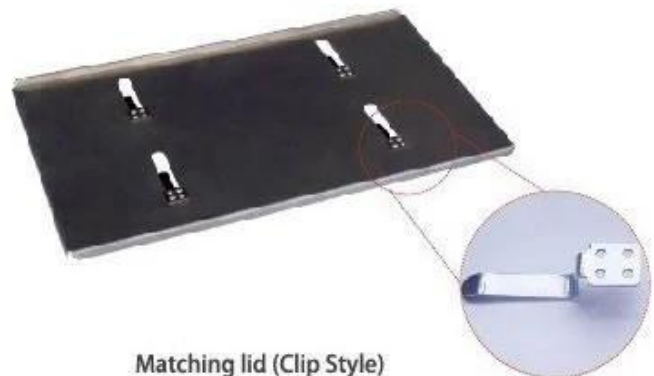

Matching lid (Clip Style)

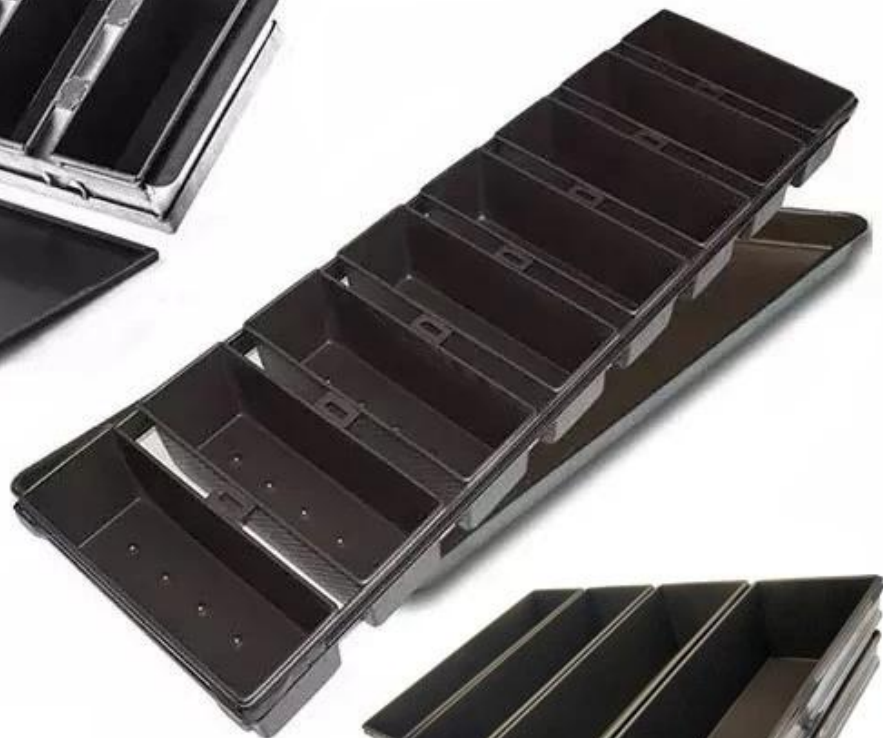

Customized shape
Customized size
Rack matched

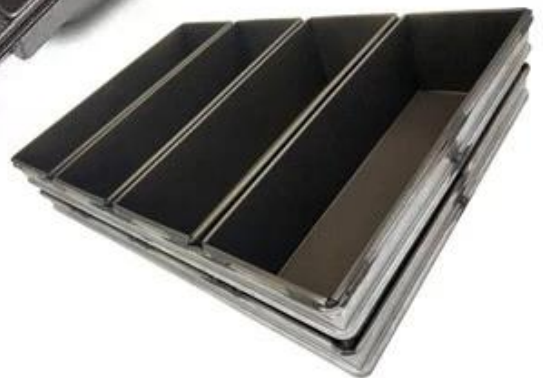

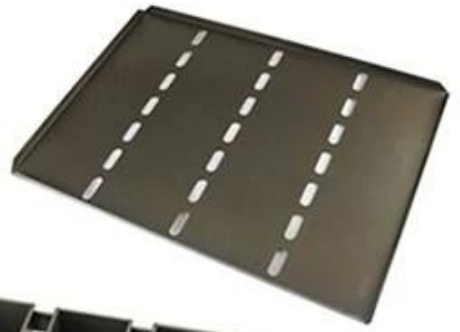

Procedures for custom made loaf baking pans

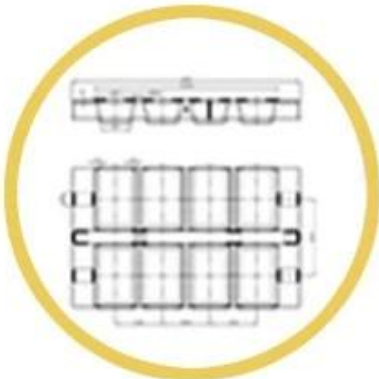

1. DRAWING



2. DESIGN



3. PRODUCT



6. SHIPPING



5. LOADING



4. PACKING

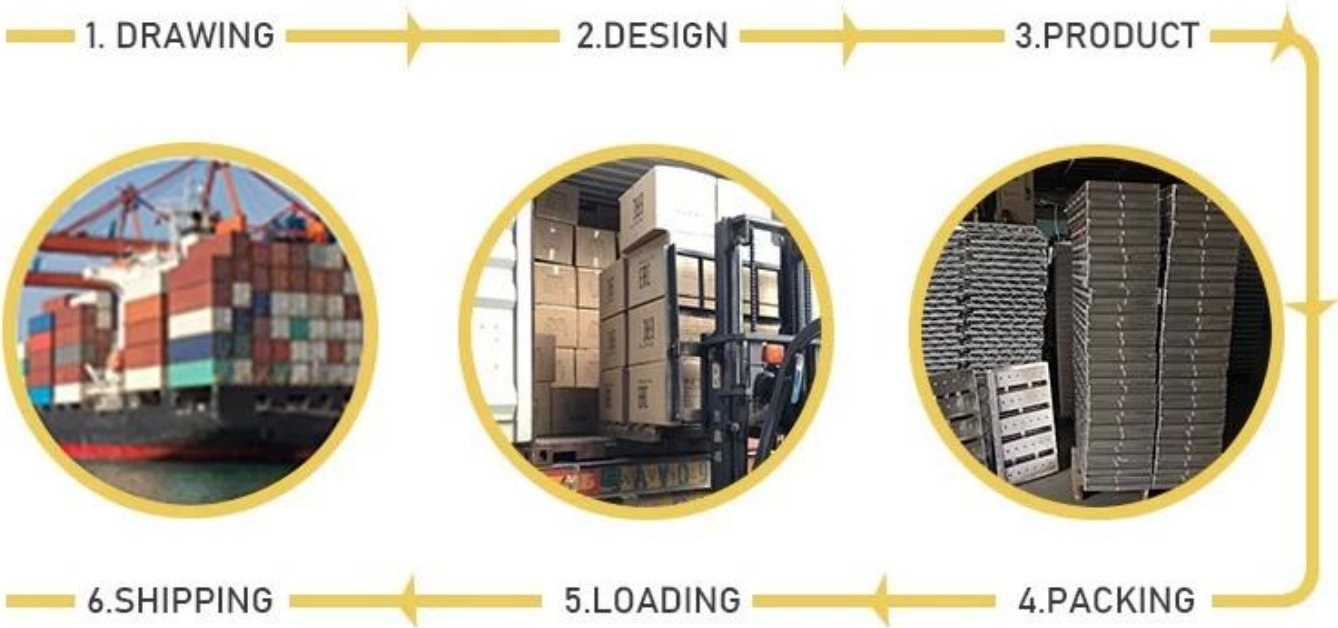

Single Loaf Pan



natural surface



corrugated



full perforation



nonstick



corrugated



golden color



holes at bottom



full perforation



custom size







Tsingbuy

