









# Commercial Bread Baking Pan with Multiple Cavities



aluminum box  
aluminum frame



aluminum box  
stainless steel frame



Aluminized steel box  
(Draw seamless construction)  
stainless steel frame



aluminum box  
stainless steel frame





**5 Cavities Strap Loaf Pan**



**5 Cavities Strap Loaf Pan with Lid**



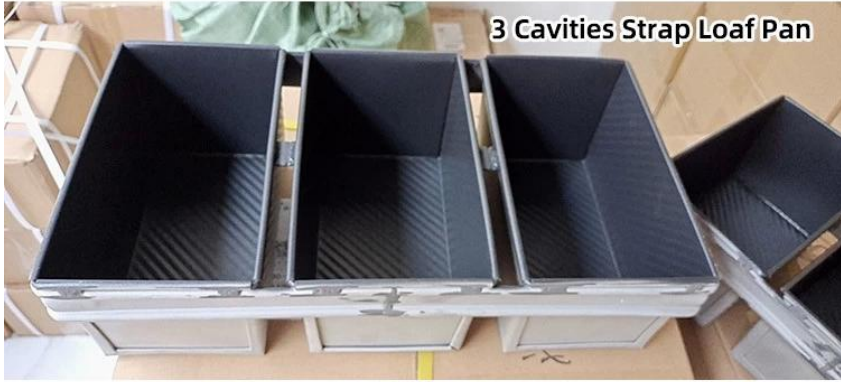

3 Cavities Strap Loaf Pan



4 Cavities Strap Loaf Pan



4 Cavities Strap Loaf Pan



5 Cavities Strap Loaf Pan



5 Cavities Strap Loaf Pan  
Ready for packing and shipping



## Professional ODM&OEM Service



## Mini Square Bread Loaf Pan

6cm/7cm/8cm/9cm/10cm for choices and custom size



## 450g Aluminum Non Stick Fluted Pullman Loaf Pan



## Custom Made Strap Bread Loaf Pan with Lid









ODM&OEM

# More Customized Strap Loaf Pans from Tsingbuy





## Customized Single Loaf Pan

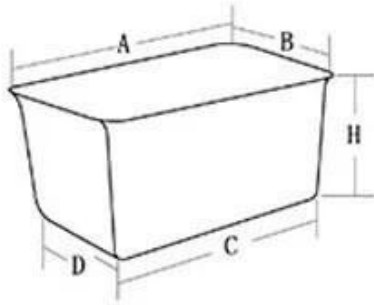

- A. Top length of the item
- B. Top width of the item
- C. Bottom length of the item
- D. Bottom width of the item
- H. Height

## Customized Strapped Loaf Pan Sets

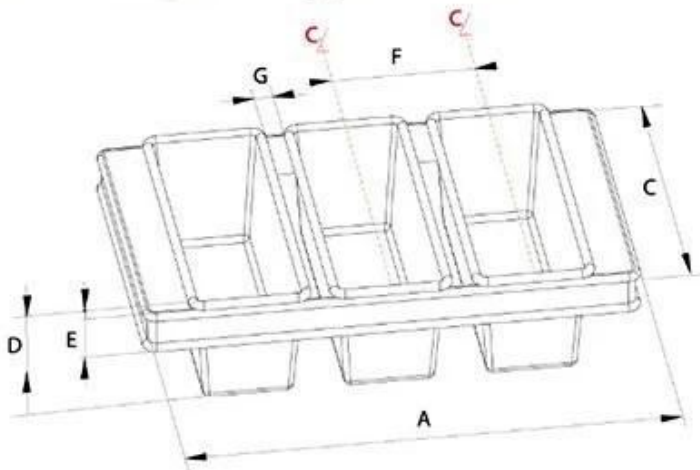

- A. Overall Length
- C. Overall Width
- D. Depth
- E. Frame Height
- F. Center-to-center
- G. Pan Distance



Flat handle



Frame handle



no handle

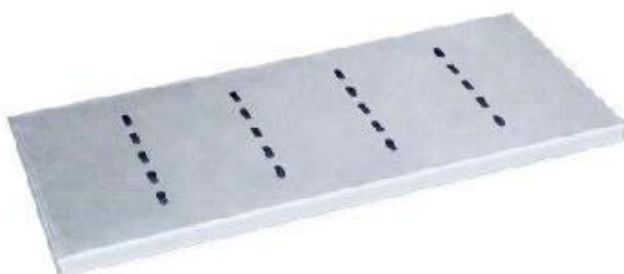

Matching lid (Drop Style)

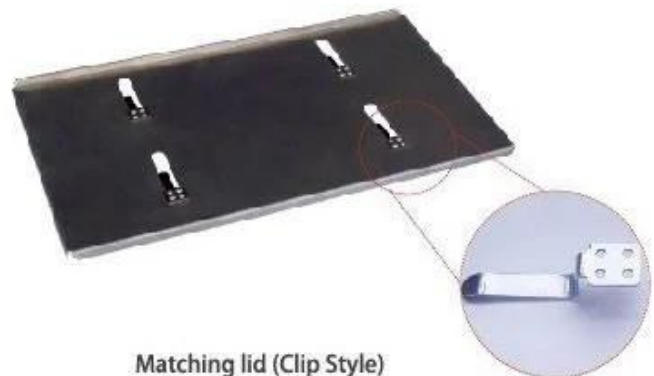

Matching lid (Clip Style)



Customized shape  
Customized size  
Rack matched

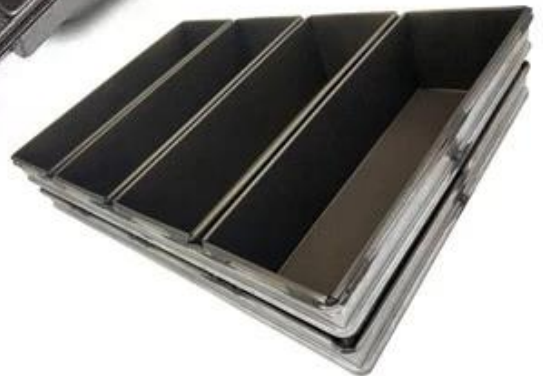

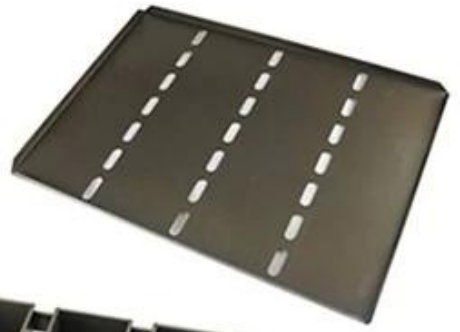

# Procedures for custom made loaf baking pans

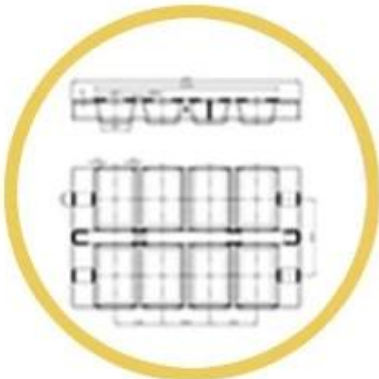

1. DRAWING



2. DESIGN



3. PRODUCT



6. SHIPPING



5. LOADING



4. PACKING





# Single Loaf Pan



natural surface



corrugated



full perforation



nonstick



corrugated



golden color



holes at bottom



full perforation



custom size











