

Pan del pane del pane tostato della padella Pan in alluminio della muffa con coperchio

Caratteristiche principali del pane di pane ondulato in alluminio PAN con coperchio

1. M.ADE di spessore 1,0 mm Lega di alluminio, Durevole per una lunga durata.
2. Superficie alimentare e corrugata e ondulata, non appiccicosa, facile da demould, facile da pulire
3. Il foro inferiore è facoltativo per meglio Circolazione dell'aria calda e riscaldamento uniforme.
4. Il filo nel design del cerchio lo rende più resistente e non facile da deformare per la lunga vita di Srvice.
5. Funzione multipla per fare panini, pane tostato, pane tradizionali del pagnotta ecc.
6. ODM & OEM è disponibile in Tsingbuy. professionale **Produttore Pullman Loaf Pan**.
7. Tsingbuy. [produttore di pane pane](#) ha fornito bakeware personalizzato per il mercato internazionale da oltre 12 anni.

Immagini di prodotto di Pan in alluminio corrugato in alluminio con coperchio

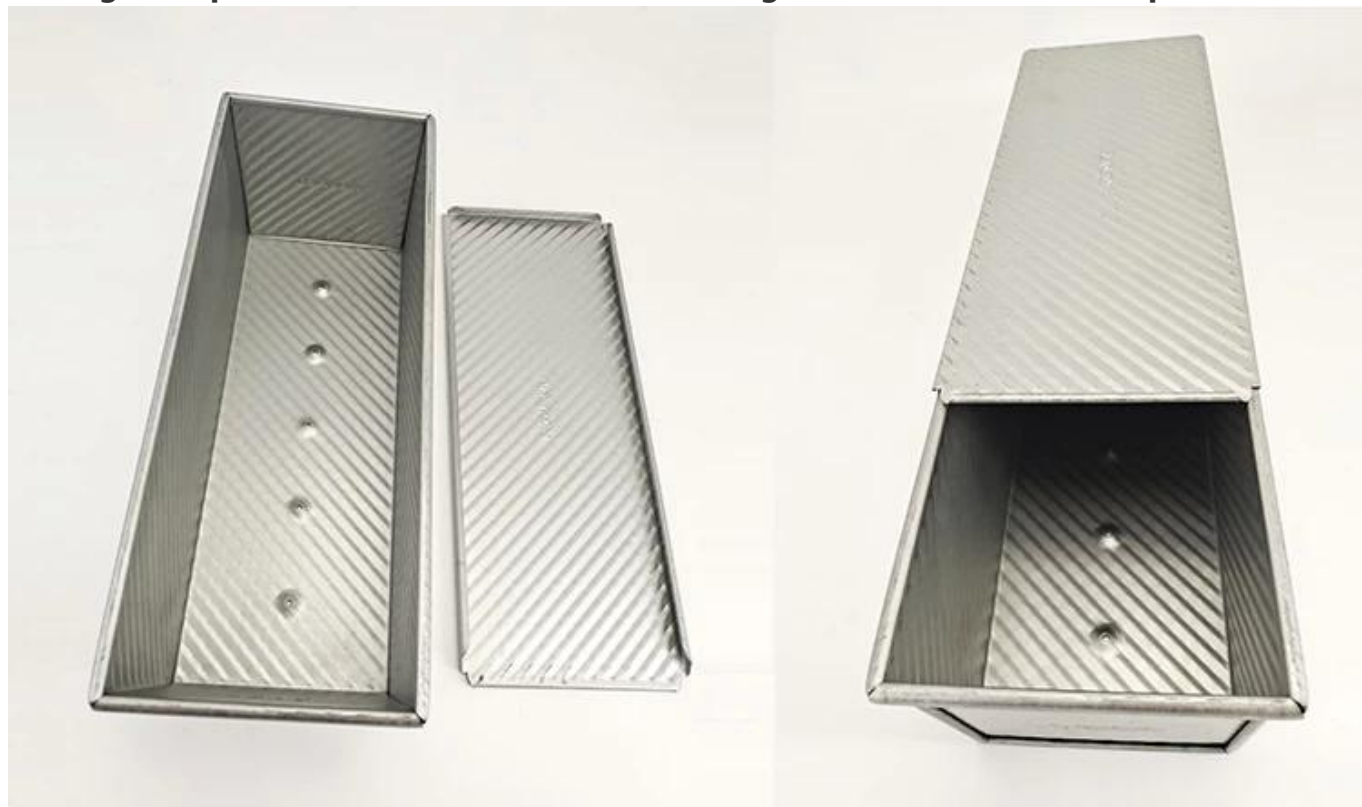









Più tipi di Pannelli in alluminio e pane pane per le tue informazioni

Ecco altri tipi per le tue informazioni da Tsingbuy [Pannelli di alluminio Factory](#).

I nostri Pullman Loaf Pans è progettato con slo stile di impleologia, bello e practicaCon. Conduzione rapida del calore, anche riscaldamento, non facile da apparire parziale Scorch.

Materiale opzionale: alluminio, acciaio alluminabile, acciaio inossidabile

Opzioni perforazione: nessuna perforazione, fondoforata, completamente perforata

Utilizzo della scena: PAN SINGOLA PALAF PAN, PAN STAGE PAN

Opzioni di superficie: liscio, ondulato, senza rivestimento, Teflon. antiaderente, non-bastone in silicone

Dimensione: qualsiasi dimensione

Coperchio: con coperchio o non come requisito.

customized single loaf pan





Teflon coating

Silicone coating

Material:

Aluminum alloy

Aluminized steel

Abitudine La produzione di cinturino Pan è una delle nostre più grandi forze, benvenuto per maggiori informazioni. Ci siamo impegnati nella produzione di bakeware da oltre 12 anni e forniamo migliaia di bakeware per i clienti internazionali. Usando la nostra cottura padella, puoi facilmente fare ogni tipo di cibo delizioso, Chiffon tortaS, torta di mousse, Libbra Torta, torta al formaggio, ecc

More Customized Strap Loaf Pans from Tsingbuy



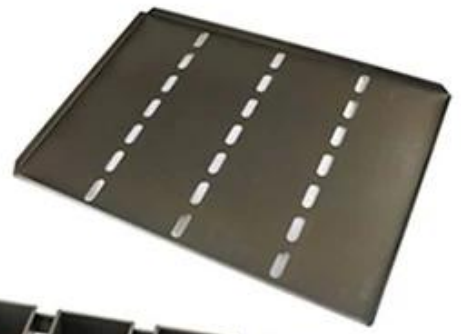



Customized shape
Customized size
Rack matched

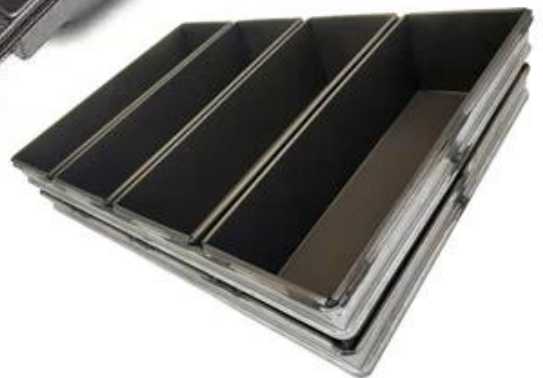

Customized Single Loaf Pan

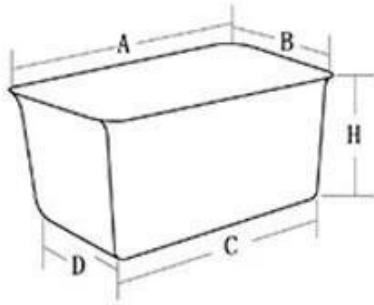

- A.Top length of the item
- B.Top width of the item
- C.Bottom length of the item
- D.Bottom width of the item
- H.Height

Customized Strapped Loaf Pan Sets

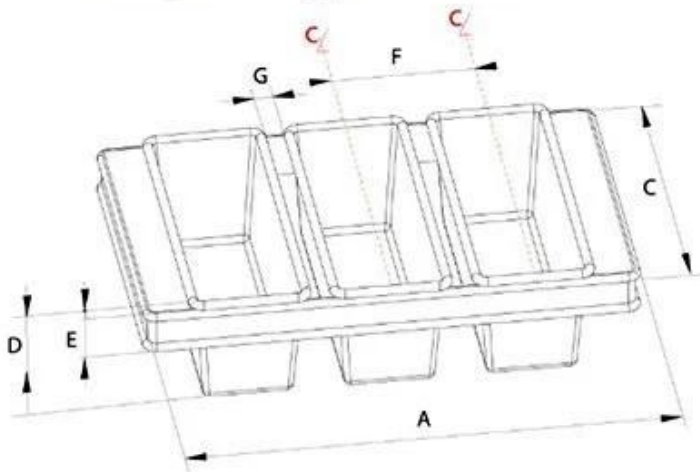

- A.Overall Length
- C.Overall Width
- D.Depth
- E.Frame Height
- F.Center-to-center
- G.Pan Distance



Flat handle



Frame handle

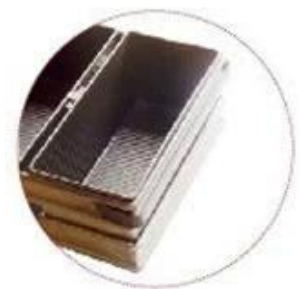

no handle



Matching lid (Drop Style)

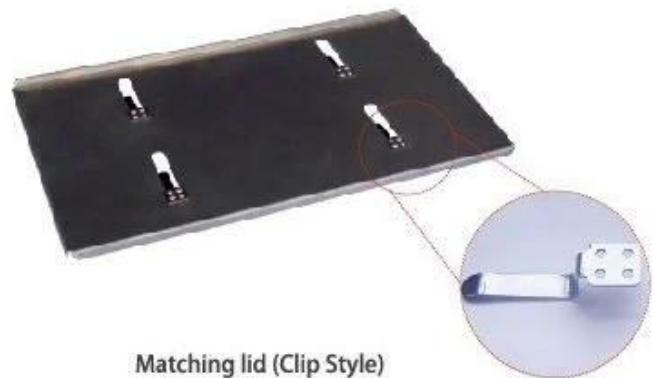

Matching lid (Clip Style)

Immagini di fabbrica



Loaf Pan

Tsingbuy Industry Limited



Benvenuti a visitarci Tsingbuy commerciale e industriale [Strap Loaf Pan con coperchio fornitore.](#)