

Stampo per teglia per pane tostato in alluminio antiaderente a forma rettangolare all'ingrosso

Caratteristiche principali della teglia antiaderente per pane tostato in alluminio

1. realizzato in lega di alluminio spessa 1,0 mm, resistente per una lunga durata.
2. La superficie antiaderente per alimenti non è appiccicosa, facile da sformare, facile da pulire
3. progettato con coperchio, è conveniente fare toast americani con i lati piatti. La superficie ondulata lo rende più comodo da sformare.
4. Il foro inferiore è opzionale per una migliore circolazione dell'aria calda e un riscaldamento uniforme.
5. Il design del filo nel cerchio lo rende più resistente e non facile da deformare per una lunga durata.
6. Funzione multipla per fare panini, toast, pagnotte tradizionali ecc.
7. ODM & OEM è disponibile nel professionista di Tsingbuy [produttore di toast](#).
8. Tsingbuy è un fornitore professionale che produce con orgoglio teglie di alta qualità, teglie da forno e fornisce prodotti da forno personalizzati per il mercato internazionale da oltre 12 anni.

Immagini del prodotto di teglia per pane tostato in alluminio antiaderente

Aluminum / Alusteel Non Stick Bread Loaf Pan







Black PTFE Non Stick
Long Bread Loaf Pan
top 254x84x55mm
bottom 250x80mm



Aluminum alloy
Light in weight
Fast heat conductivity
Non stick coated
Easy to demould
Easy for cleanup







Più tipi di teglie per pane e pagnotte per tua informazione

Ecco altri disegni per le teglie per il pane.

Le nostre padelle Pullman sono progettate con uno stile semplice, belle e pratiche con una rapida conduzione del calore, riscaldamento uniforme, non è facile apparire bruciature parziali.

Materiale opzionale: alluminio, acciaio alluminato, acciaio inossidabile

Opzioni di perforazione: nessuna perforazione, perforata sul fondo, completamente perforata

Utilizzo della scena: teglia singola, teglia con cinturino

Opzioni di superficie: liscia, ondulata, senza rivestimento, antiaderente in teflon, antiaderente in silicone

Taglia: qualsiasi taglia

Coperchio: con coperchio o meno come richiesto.

customized single loaf pan





Oltretutto [teglia per pane cinese all'ingrosso](#), anche la produzione personalizzata di teglia con cinturino è uno dei nostri più grandi punti di forza, benvenuto per maggiori informazioni.

Ci occupiamo della produzione di prodotti da forno da oltre 12 anni e forniamo migliaia di prodotti da forno per clienti internazionali. Usando la nostra teglia, puoi facilmente preparare tutti i tipi di cibo delizioso, torte chiffon, torta mousse, torta Pound, torta al formaggio, ecc.

More Customized Strap Loaf Pans from Tsingbuy



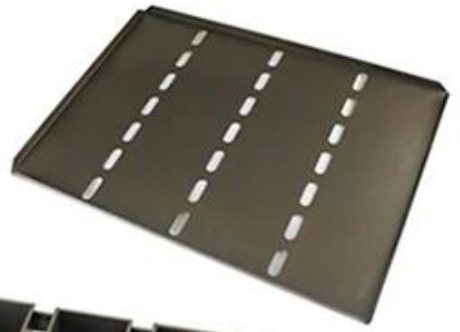

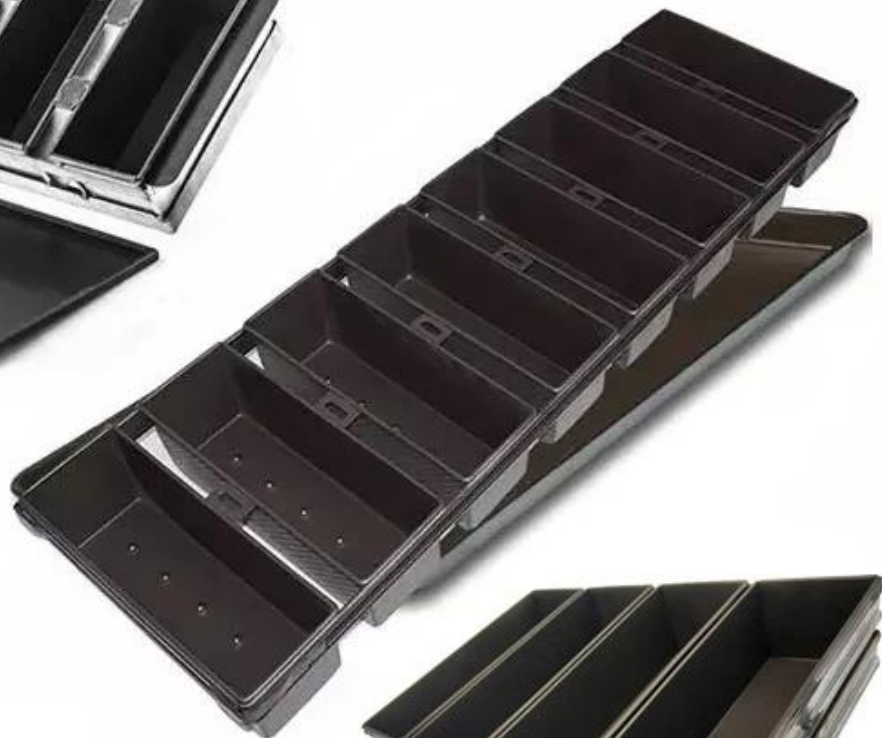

Customized shape
Customized size
Rack matched

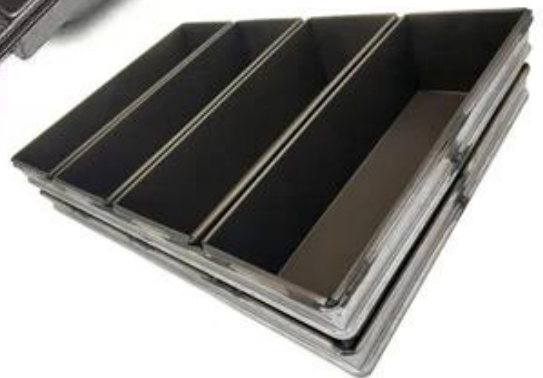

Customized Single Loaf Pan

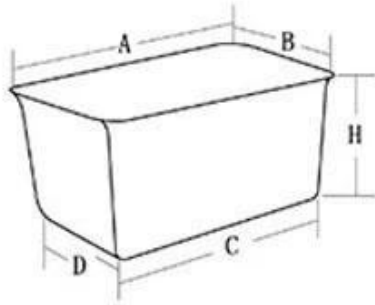

- A. Top length of the item
- B. Top width of the item
- C. Bottom length of the item
- D. Bottom width of the item
- H. Height

Customized Strapped Loaf Pan Sets

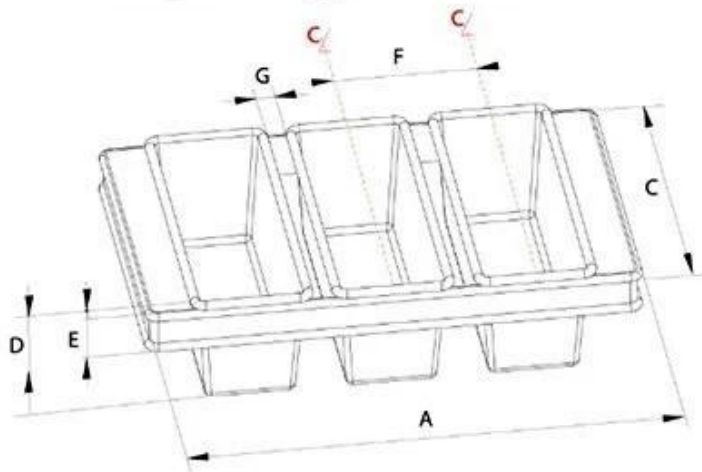

- A. Overall Length
- C. Overall Width
- D. Depth
- E. Frame Height
- F. Center-to-center
- G. Pan Distance



Flat handle



Frame handle

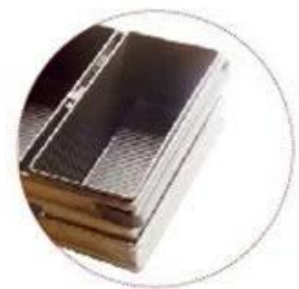

no handle



Matching lid (Drop Style)

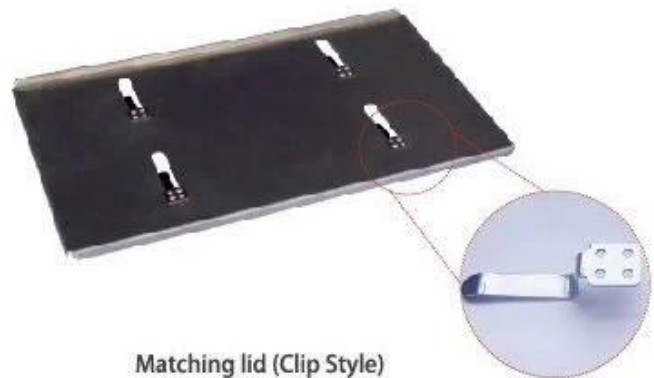

Matching lid (Clip Style)

Immagini di fabbrica

Tsingbuy [fornitore di padelle antiaderenti](#) produce anche teglie, teglie, teglie per baguette, teglie per cupcake, teglie per torte ecc. Per panifici, fabbriche alimentari, ristoranti per uso commerciale. Il servizio ODM&OEM è la nostra più grande forza. Non esitare a contattarci se stai cercando teglie commerciali.



Loaf Pan

Tsingbuy Industry Limited



