

304 inossidabile Steel Stampi ad anello per torta a forma di cuore per mousse da forno

Caratteristiche principali di a forma di cuore s acciaio inossidabile Stampi per anelli di torta di mousse

Acciaio inossidabile 304 di alta qualità

Tsingbuy [fabbrica di anelli di mousse](#) si applica h materiale in acciaio inossidabile di alta qualità, che può entrare direttamente in contatto con il cibo, sicuro da usare, ad alta resistenza, non facile da deformare, non facile da arrugginire ed eccellente resistenza alla corrosione.

Design con bordo arrotondato

Speciale design del bordo arricciato sia sul lato superiore che inferiore, senza raschiare, facile da prendere e posizionare

La perforazione su acciaio inossidabile è facoltativa

La superficie perforata è buona per un riscaldamento uniforme e veloce per la dissipazione del calore. Puoi scegliere se essere perforato in base alle tue esigenze.

Varie forme e più dimensioni per le opzioni

Rotondo, ovale, quadrato, rettangolo, cuore, esagono e molte altre forme sono opzionali, creando liberamente opere d'arte gourmet.

Immagini di s a forma di cuore acciaio inossidabile Stampi per anelli di torta di mousse

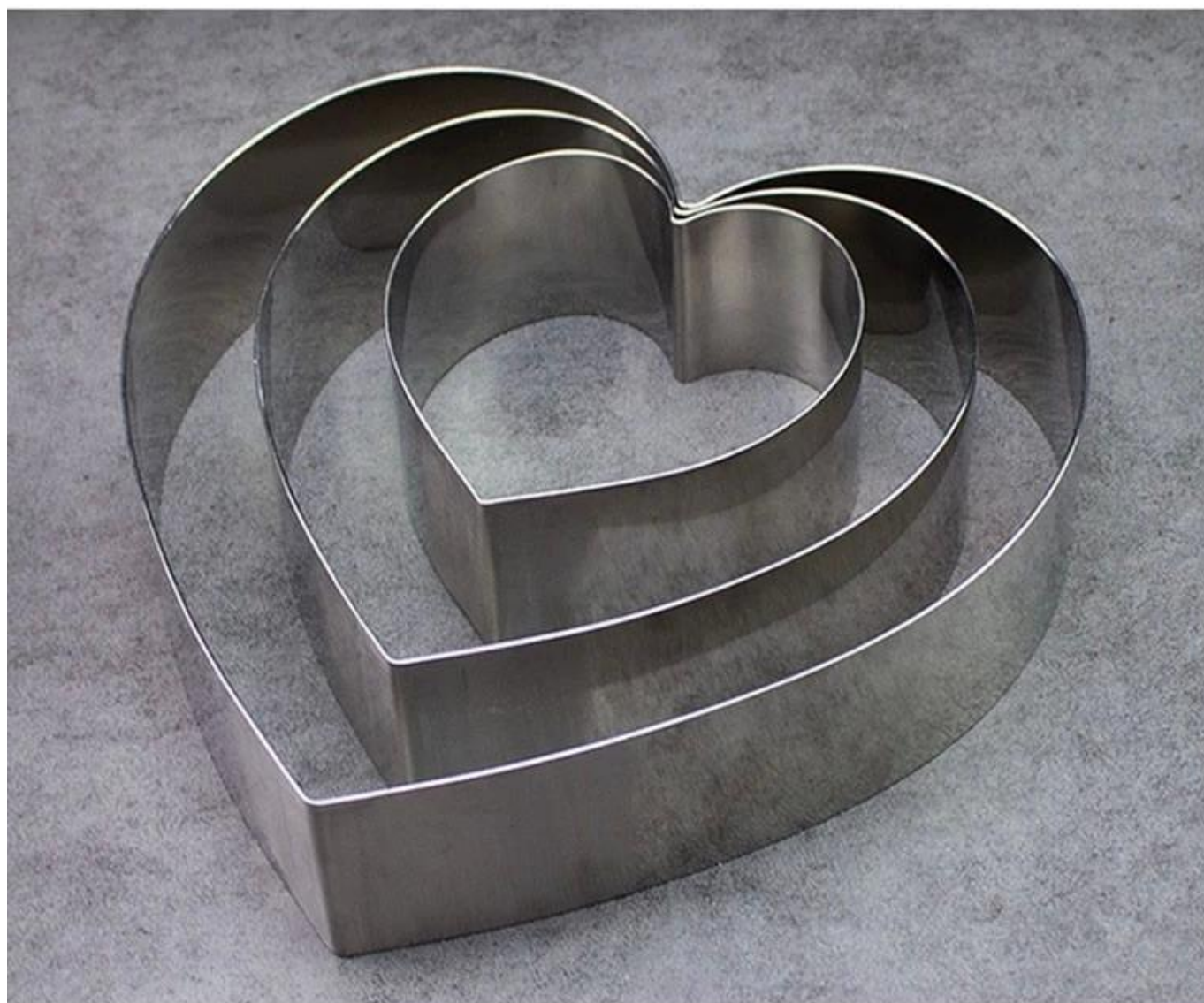



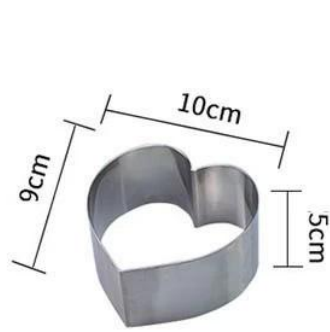

4 inch

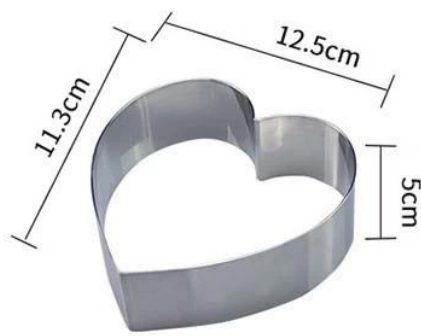

5 inch

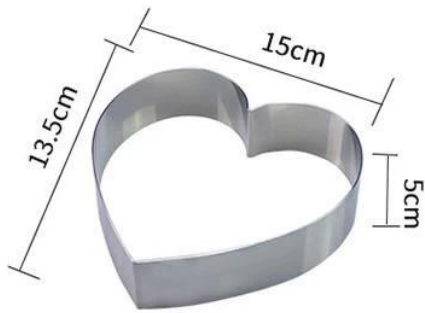

6 inch

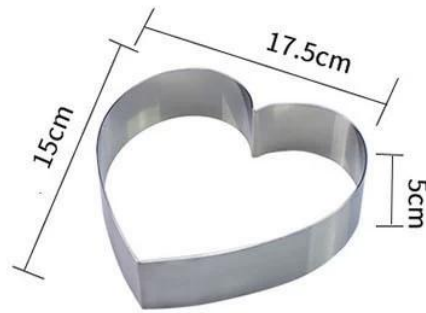

7 inch

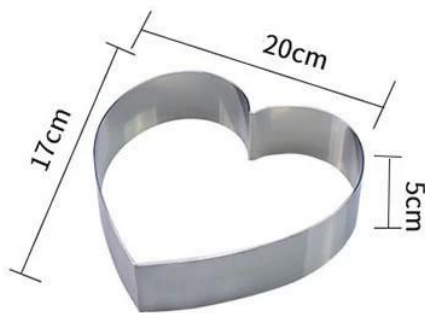

8 inch

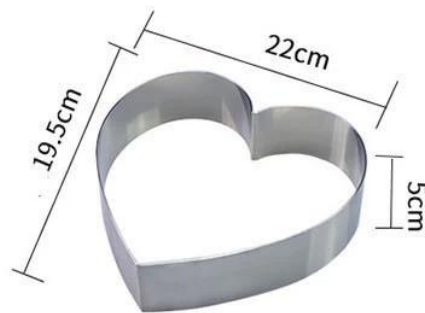

9 inch

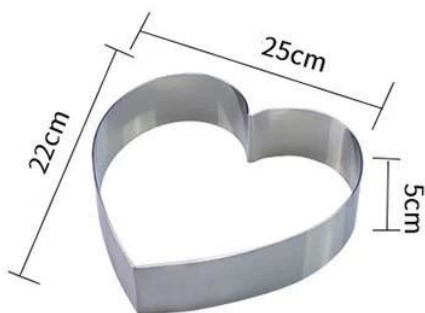

10 inch







Altri stampi da forno che potrebbero interessarti

Ecco altri stampi per dolci da Tsingbuy [produttore di stampi per dolci](#) . Che tu stia cercando uno stampo per torta da forno normale o uno stampo per torta personalizzato, non esitare a venire da noi.



Non-stick Coated Cake Pans



Anodized Surface



Custom Size



Custom Design



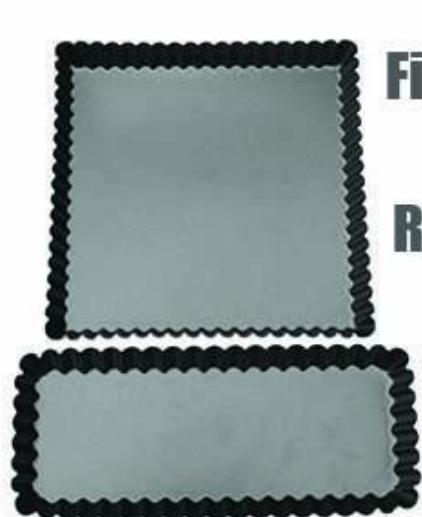

non-stick coated

**Fixed bottom
Square
Rectangular**



anodized surface



Detachable / removable bottom





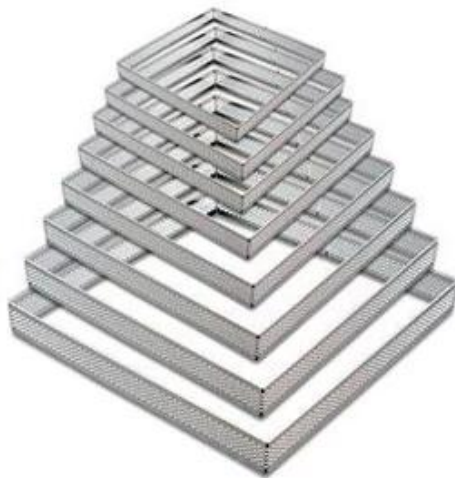

Spettacolo di fabbrica

Oltretutto [vendita all'ingrosso stampi per dolci a forma di cuore](#), il produttore di prodotti da forno Tsingbuy fornisce anche tortiere in alluminio, vassoi in alluminio, teglia per baguette in alluminio, teglia per pane, teglie per cupcake multistampo ecc., Oltre al servizio ODM e OEM di forniture da forno. Non esitare a contattarci in qualsiasi momento.

Production Machines



Automatic cutting machine



Automatic punching machine



Punching machine



Bending machine



Sand blasting machine

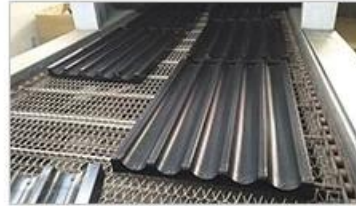

Drying machine

Our Advantages



Professional machine



Standard production flow



Experienced workers



Clean & tidy warehouse



Quick production fast dispatch

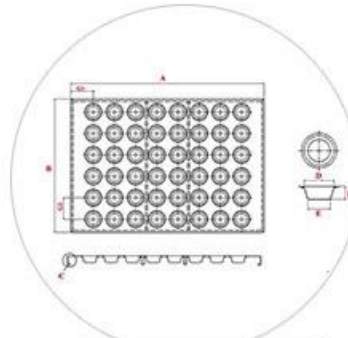

ODM & OEM service