

Fabbrica ODM&OEM Bakeware, Stampo per teglia per padella e tostato con sandwich antiaderente scanalato Pullman in metallo di alluminio con coperchio

### **Caratteristiche principali della teglia per pane scanalata antiaderente in teflon a doppia faccia con coperchio**

1. **Materiale in alluminio di alta qualità:** Realizzata in alluminio di alta qualità, la nostra teglia per pane è progettata per fornire una distribuzione uniforme del calore, garantendo che il tuo pane cuocia sempre alla perfezione.

2. **Rivestimento antiaderente in Teflon su entrambi i lati con superficie ondulata:** Di' addio ad attaccamenti e strappi con il nostro rivestimento antiaderente in Teflon su entrambi i lati. La superficie ondulata (superficie scanalata) non solo impedisce al pane di attaccarsi, ma conferisce anche una consistenza attraente alle pagnotte, rendendole una festa per gli occhi e per le papille gustative.

3. **Molteplici dimensioni standard e opzioni personalizzate:** Che tu sia un fornaio professionista o un appassionato casalingo, abbiamo la soluzione per te. Scegli dalla nostra gamma di dimensioni standard o opta per una dimensione personalizzata per soddisfare le tue esigenze specifiche. Crediamo nella flessibilità per soddisfare le vostre esigenze specifiche.

4. **Durata di livello commerciale:** Costruita per resistere ai rigori di una panetteria, di un ristorante o di una fabbrica alimentare, la nostra teglia per pane è di livello commerciale e può resistere a un uso intenso. Tuttavia, non è solo per i professionisti: è anche la scelta di migliore qualità per la tua cucina di casa, garantendo che il tuo pane fatto in casa sia buono come quello di qualsiasi panetteria.

5. **Realizzato con orgoglio da professionisti in Cina:** Tsingbuy è un [produttore di teglie per pullman commerciali](#) con sede in Cina con oltre 15 anni di esperienza e apprezzato da clienti fedeli provenienti da oltre 180 paesi. La nostra padella per pane è un prodotto fondamentale nella nostra gamma. Quando scegli la nostra teglia, non stai solo scegliendo un prodotto; stai scegliendo un partner per il successo della cottura. Conta su di noi per aiutarti a eccellere nel tuo mercato locale e migliorare il tuo gioco di pasticceria.

### **Immagini del prodotto della teglia per pane scanalata antiaderente in teflon a doppia faccia con coperchio**



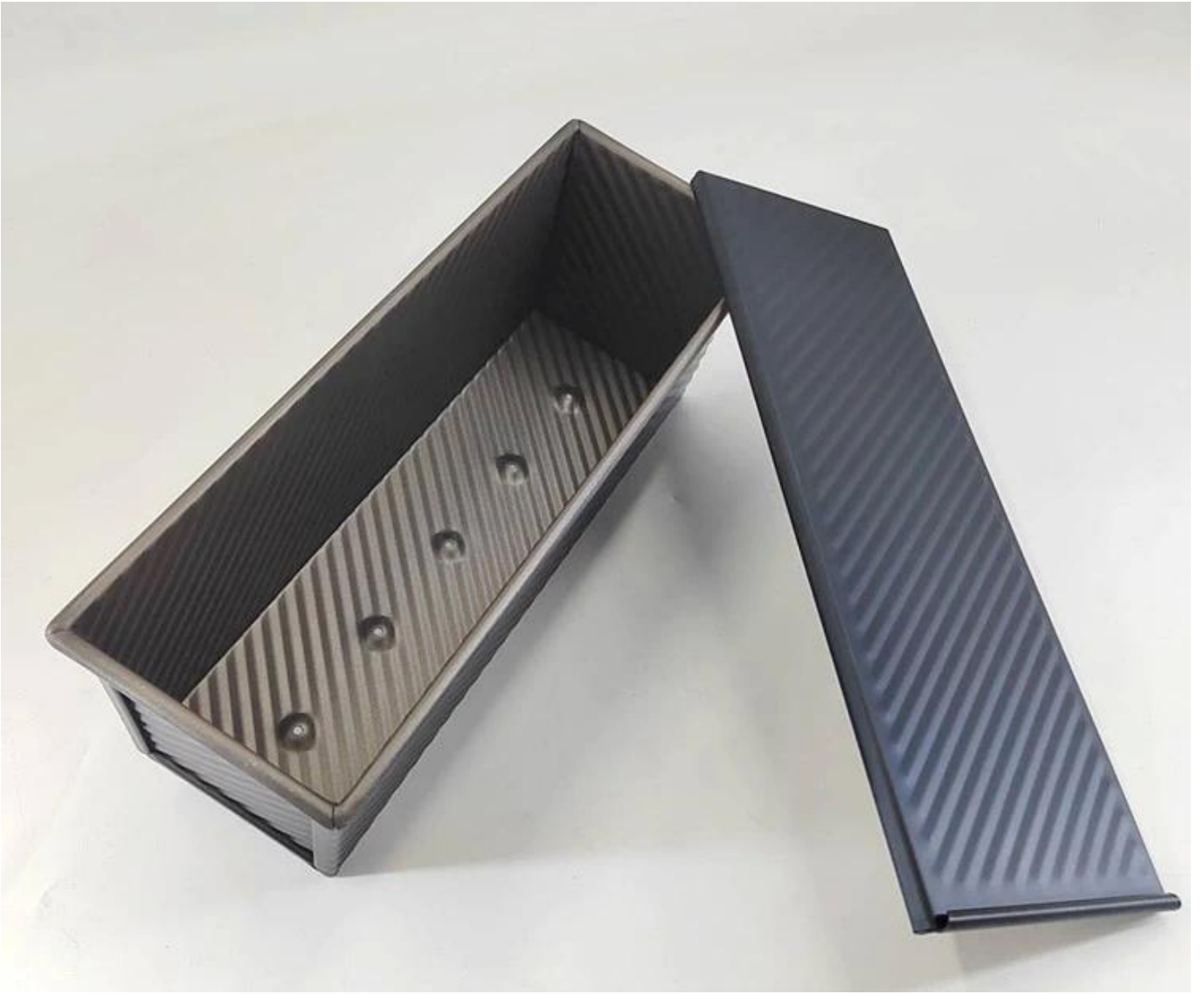







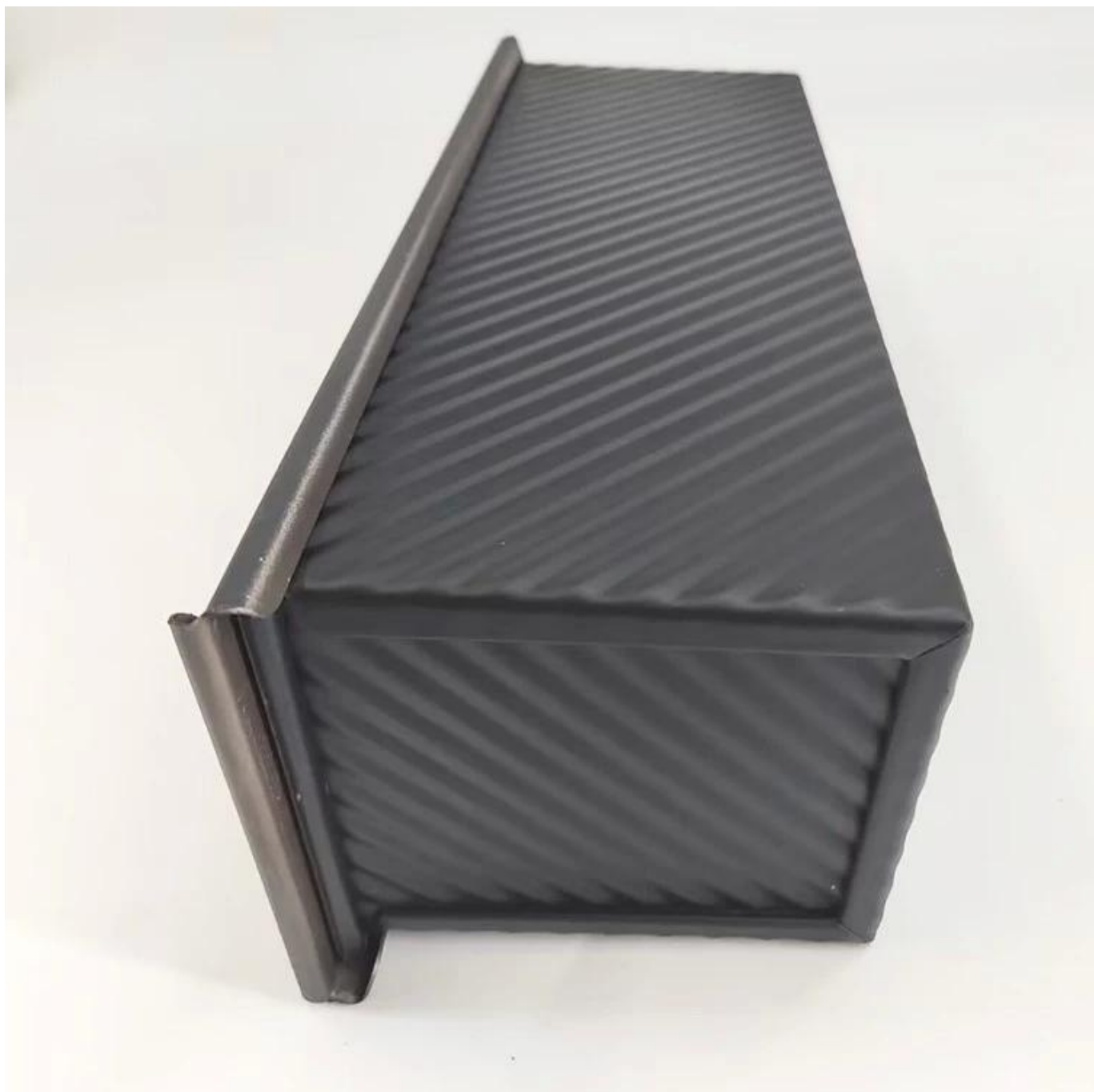





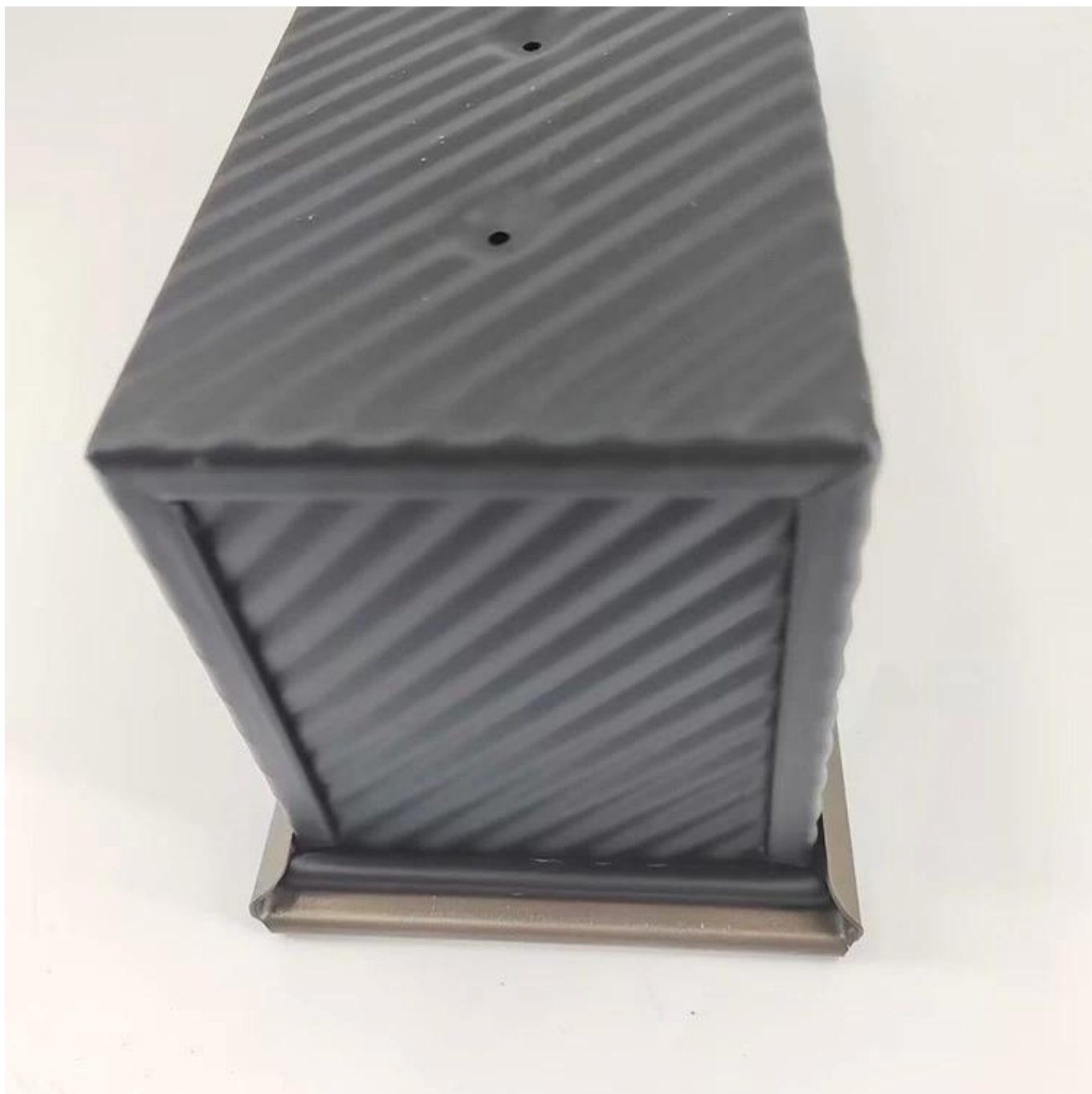

### **Altri tipi di teglie per pane e pagnotta per tua informazione**

Eccone altri [padelle in alluminio all'ingrosso](#) sia per la panetteria che per l'uso in cucina domestica.

Le nostre padelle per pullman sono progettate con uno stile semplice, bello e pratico con conduzione rapida del calore, riscaldamento uniforme, non facile da apparire bruciatura parziale.

Materiale opzionale: alluminio, acciaio alluminato, acciaio inossidabile

Opzioni di perforazione: nessuna perforazione, perforata sul fondo, interamente perforata

Utilizzo della scena: teglia singola, teglia con cinghia

Opzioni di superficie: liscia, ondulata, senza rivestimento, antiaderente in teflon, antiaderente in silicone

Dimensioni: qualsiasi dimensione

Coperchio: con coperchio o meno a seconda delle vostre esigenze.

# customized single loaf pan





Costume la produzione di teglie per pane con cinghie è uno dei nostri più grandi punti di forza, benvenuto per maggiori informazioni.

Tsingbuy [fornitore di pagnotte antiaderenti](#) è impegnata nella produzione di prodotti da forno da oltre 12 anni e fornisce migliaia di prodotti da forno per clienti internazionali. Usando la nostra cottura pan , puoi facilmente preparare tutti i tipi di cibi deliziosi, Chiffon torte, torta con mousse, Torta di libbra, torta di formaggio, ecc

## More Customized Strap Loaf Pans from Tsingbuy





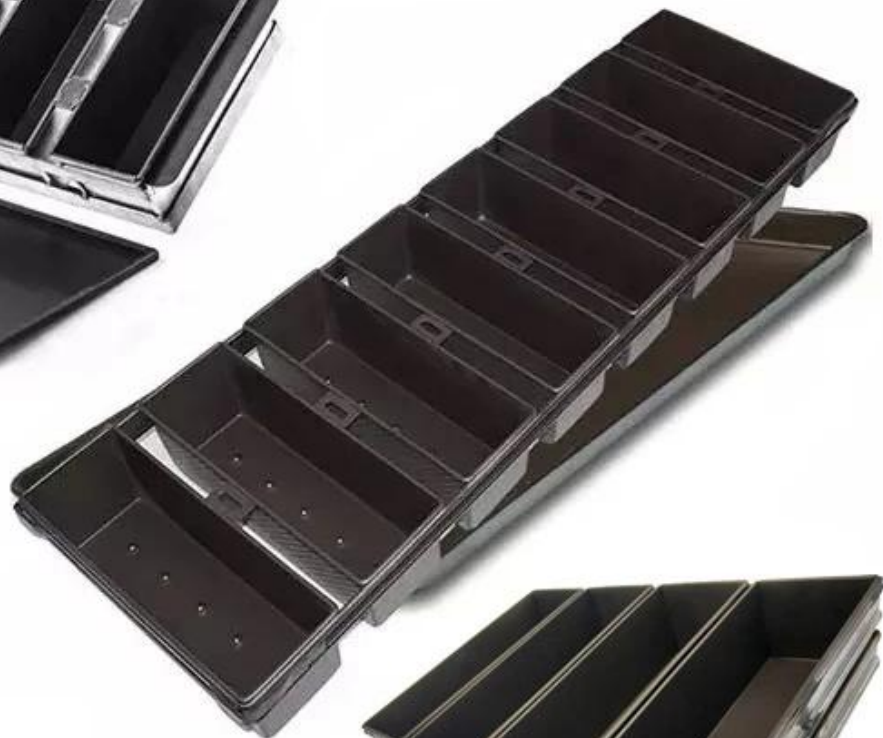

Customized shape  
Customized size  
Rack matched

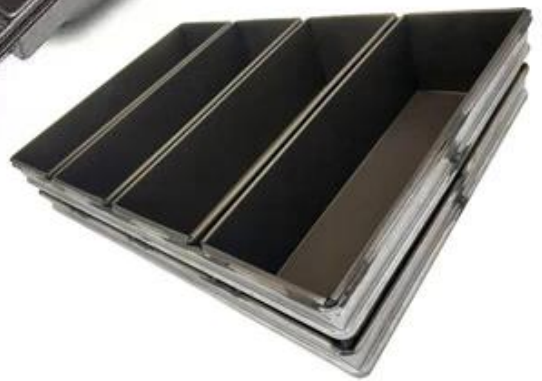

## Customized Single Loaf Pan

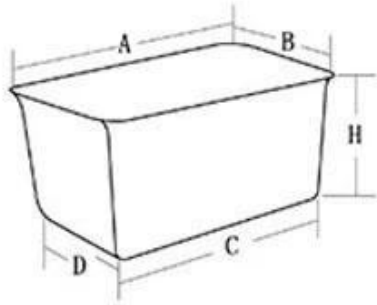

- A.Top length of the item
- B.Top width of the item
- C.Bottom length of the item
- D.Bottom width of the item
- H.Height

## Customized Strapped Loaf Pan Sets

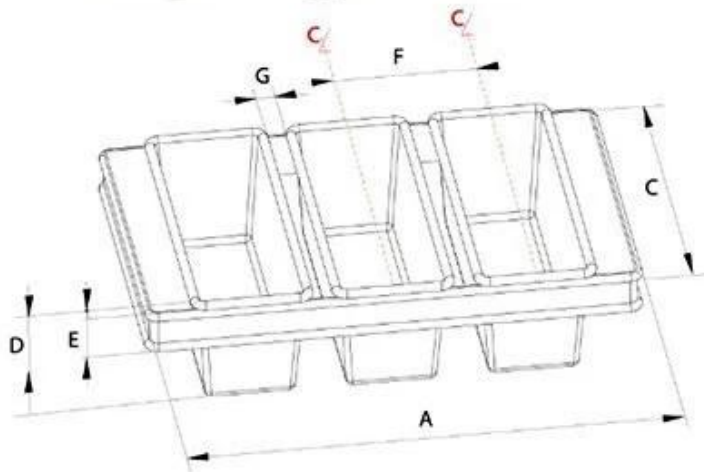

- A.Overall Length
- C.Overall Width
- D.Depth
- E.Frame Height
- F.Center-to-center
- G.Pan Distance



Flat handle



Frame handle

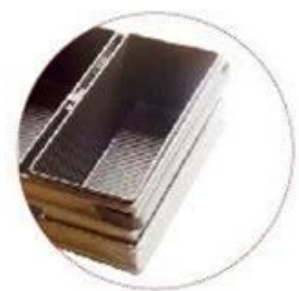

no handle

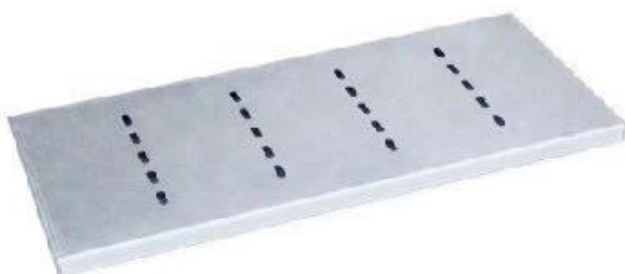

Matching lid (Drop Style)

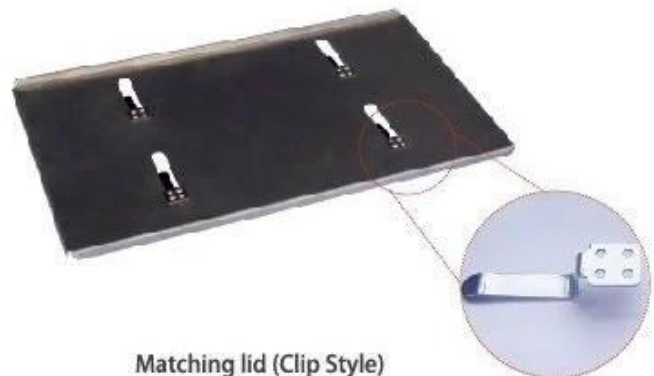

Matching lid (Clip Style)

Immagini della fabbrica di pagnotte e teglie Tsingbuy

## Pictures of Workshop











