

Set di stampi per teglia da forno per pane tostato in acciaio alluminato per uso industriale su misura antiaderente a 10 cavità

Caratteristiche principali del set di teglie per pane in acciaio alluminizzato su misura a 10 cavità con cinturino antiaderente

1. Questa teglia per pane commerciale è in grado di contenere (10) pagnotte, ciascuna scatola con dimensioni 165x80 mm. Questo prodotto permette di produrre dieci pagnotte da vendere o servire velocemente mantenendo comunque la qualità della cottura. Sia che tu abbia bisogno di preparare le tue tipiche pagnotte per la cena o pane di stagione, questa teglia è una buona scelta per aiutarti a finire facilmente il tuo lavoro di cottura.
2. Le teglie per pane sono realizzate in alluminio da 0,7/1,0/1,2 mm acciaio inossidabile con angoli a doppia piegatura, il bordo di ogni padella è dotato di un filo del cerchio di 5 mm di diametro. Le cornici sono fabbricate in Alluminio 1,2 mm acciaio inossidabile per super supporto e durata. La superficie delle teglie ha finitura scanalata e sono dotate di fori per il vapore. Non adatto per miscele senza glutine.
3. Questo cinturino per il pane la teglia è prodotta in Cina [produttore di padelle di grandi dimensioni](#) -Tsingbuy industria limitata. Esso è disponibile in una gamma di dimensioni, in varie configurazioni per adattarsi a tutti i forni industriali, commerciali o domestici.

Immagini del prodotto di set di teglie per pane in acciaio alluminizzato su misura a 10 cavità con cinturino antiaderente







3 pcs



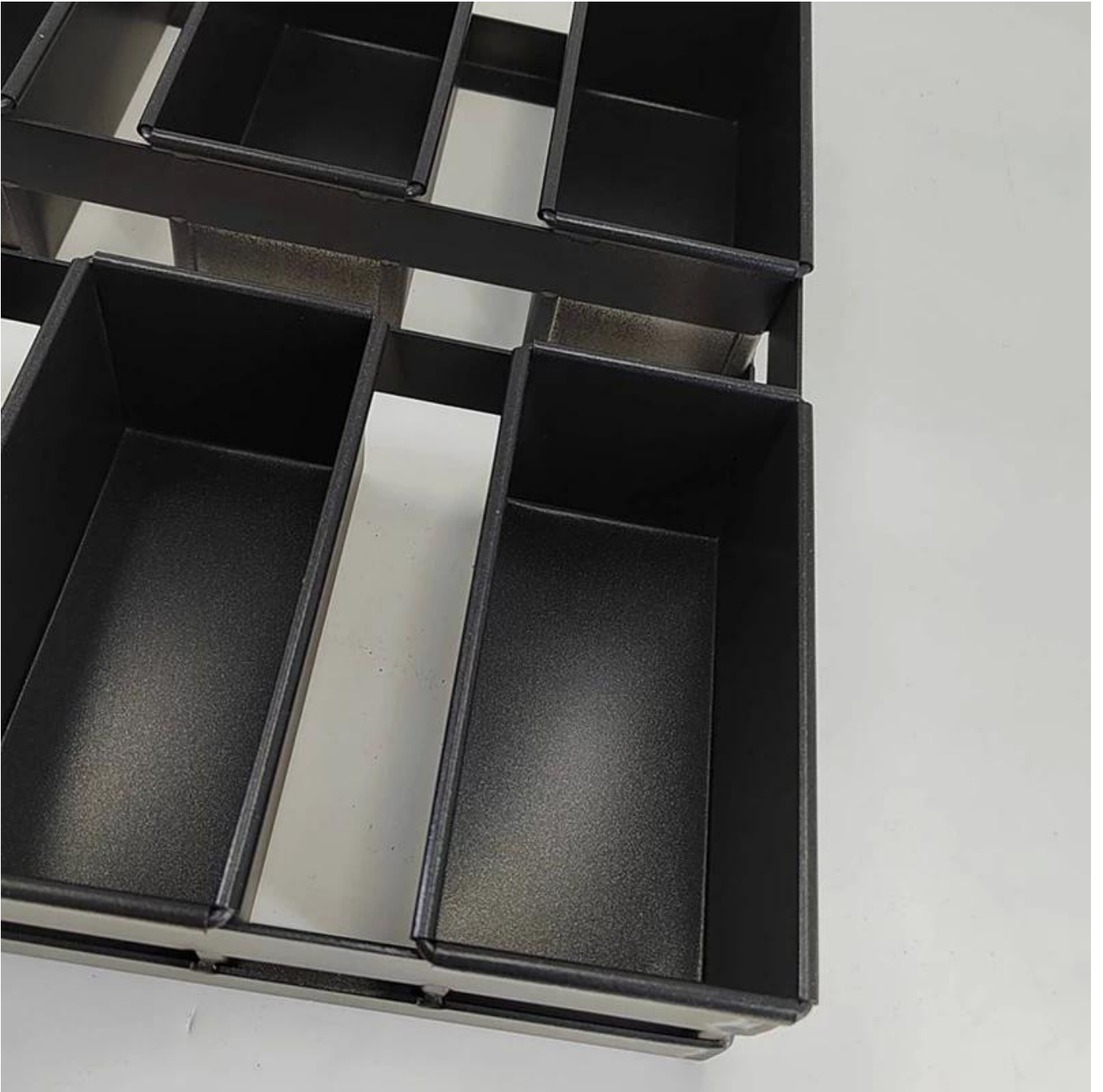



Tsingbuy is professionale In fabbricazione Entrambi separare pagnotta padella E cinghia pagnotta padelle. Qui Noi condividere alcuni modelli di padella con cinturino come riferimento. La maggior parte delle padelle con cinturino sono progettate su misura in base alle esigenze.

More Customized Strap Loaf Pans from Tsingbuy



Customized Single Loaf Pan

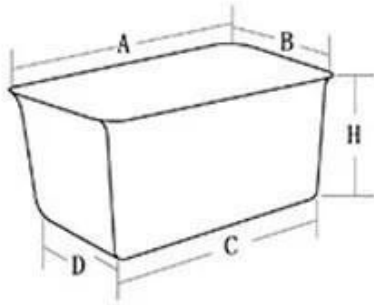

- A. Top length of the item
- B. Top width of the item
- C. Bottom length of the item
- D. Bottom width of the item
- H. Height

Customized Strapped Loaf Pan Sets

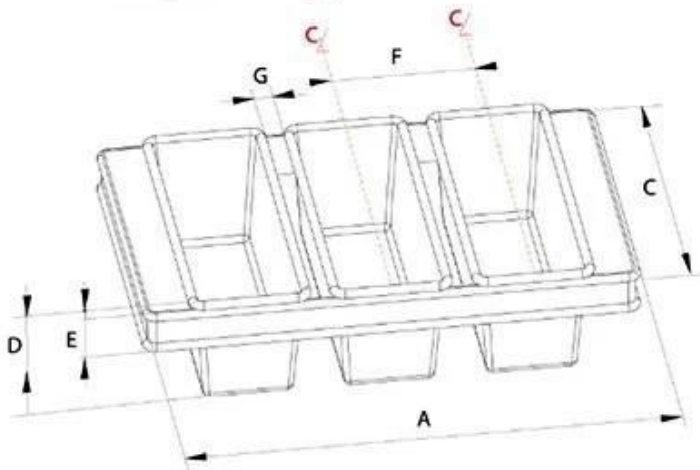

- A. Overall Length
- C. Overall Width
- D. Depth
- E. Frame Height
- F. Center-to-center
- G. Pan Distance



Flat handle



Frame handle



no handle



Matching lid (Drop Style)

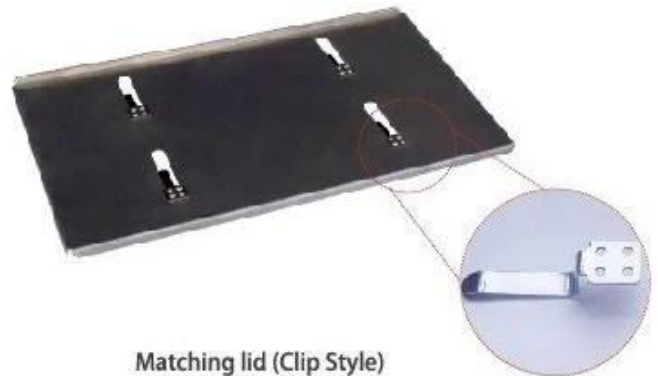

Matching lid (Clip Style)

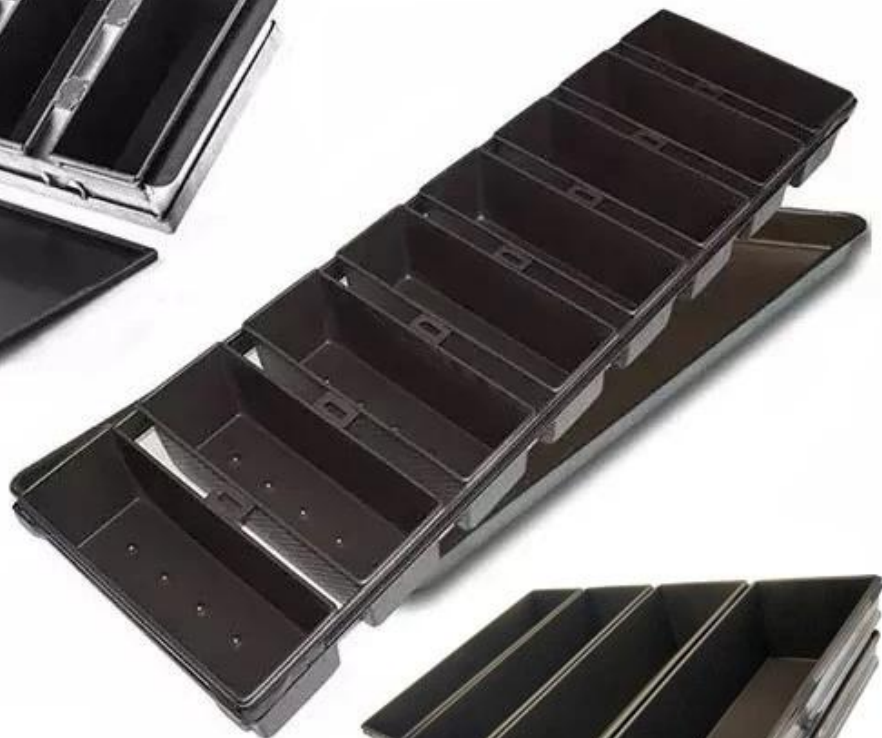

Customized shape
Customized size
Rack matched

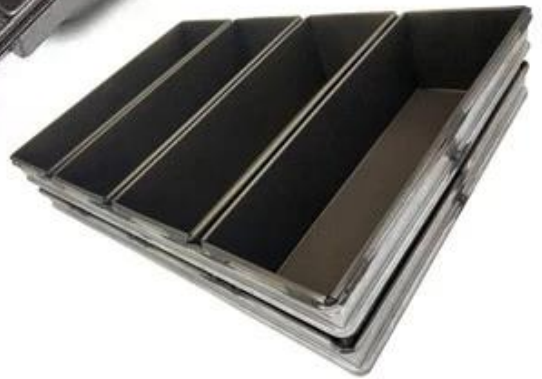

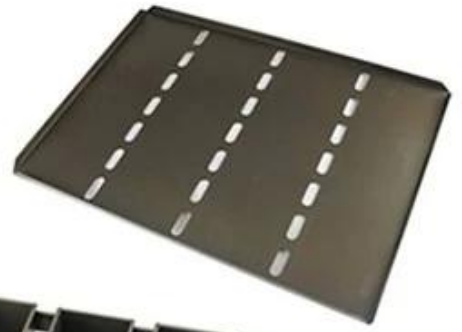

Procedures for custom made loaf baking pans

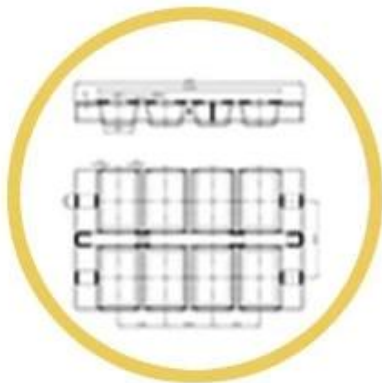

1. DRAWING



2. DESIGN



3. PRODUCT



6. SHIPPING



5. LOADING



4. PACKING



**Custom Made
Strap Loaf Pan
Used with
Bakery Trolley**



Più tipi di teglia per pane singolo per cucina domestica, panetteria, ristorante ecc
Ecco alcuni classici modelli di pagnotta singola teglia da Tsingbuy [fornitore di padelle antiaderenti](#).

Single Loaf Pan



natural surface



corrugated



full perforation



nonstick



corrugated



golden color



holes at bottom



full perforation



custom size



Immagini di fabbrica dal produttore di teglie per pane Tsingbuy





Oltretutto [commercio all'ingrosso di teglie per pane](#), Tsingbuy produttore di prodotti da forno fornisce anche progettazione personalizzata e vendita all'ingrosso di altri prodotti da forno commerciali, come teglie , baguette padelle, padelle , teglie multi-stampo, carrello da forno, teglie per torte ecc. Benvenuti a consulta noi in qualsiasi momento.

