

450g Alluminio Lega Antiaderente Pagnotta ondulata antiaderente per padellae teglia con coperchi scorrevoli

Caratteristiche principali di

450g ondulato pagnotta pane pan toast sandwich pane cottura stampo

1. realizzato con uno spessore di 1,0 mm Lega di alluminio , .
2. F resistente al cibo e ondulata la superficie antiaderente non è appiccicosa, facile da sformare, facile da pulire
3. progettato con coperchio, è conveniente fare toast americani con piatto .
4. Il foro inferiore è facoltativo per il meglio.
5. Il design del filo nel cerchio lo rende più resistente e non facile da deformare per una lunga durata.
6. Funzione multipla per fare panini, toast, pagnotte tradizionali ecc.
7. ODM e OEM è disponibile in Tsingbuy professionale [pane padella.](#)
8. Tsingbuy è un fornitore professionale che da oltre 12 anni produce con orgoglio teglie da forno di alta qualità, teglie per pullman e fornisce prodotti da forno personalizzati per il mercato internazionale.

Immagini del prodotto di

450g teglia per pane in alluminio pullman con coperchio

450G Aluminum Pullpan Loaf Pan Black/Golden Corrugated Nonstick



Product Specification

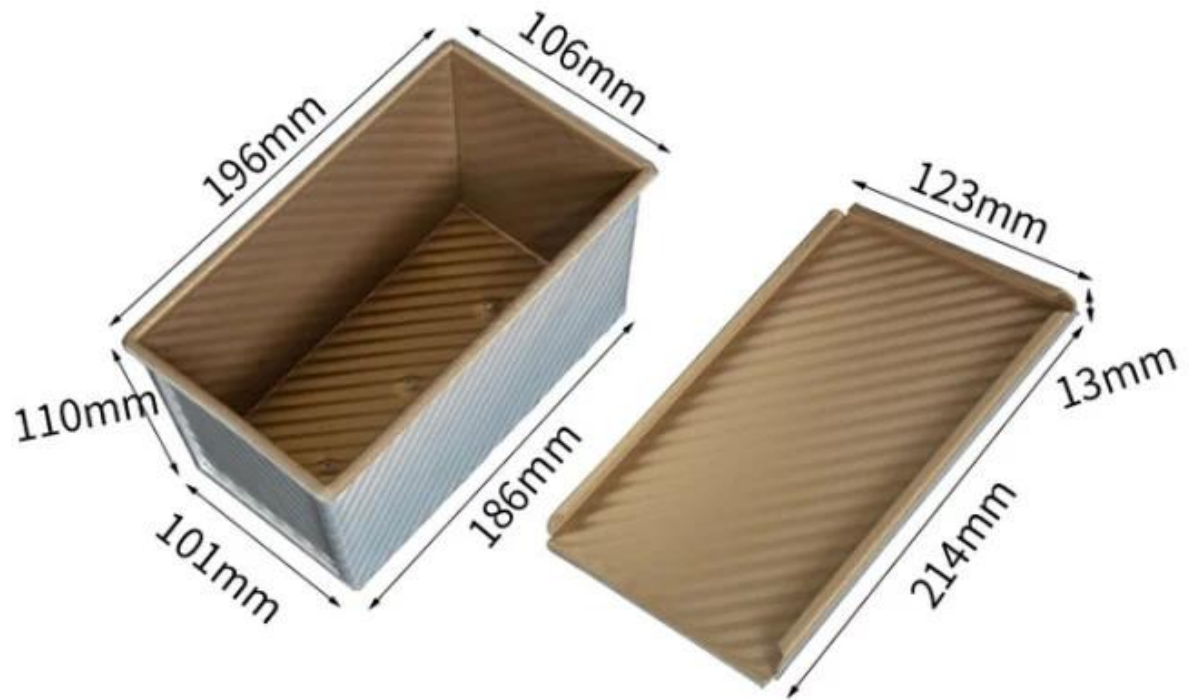

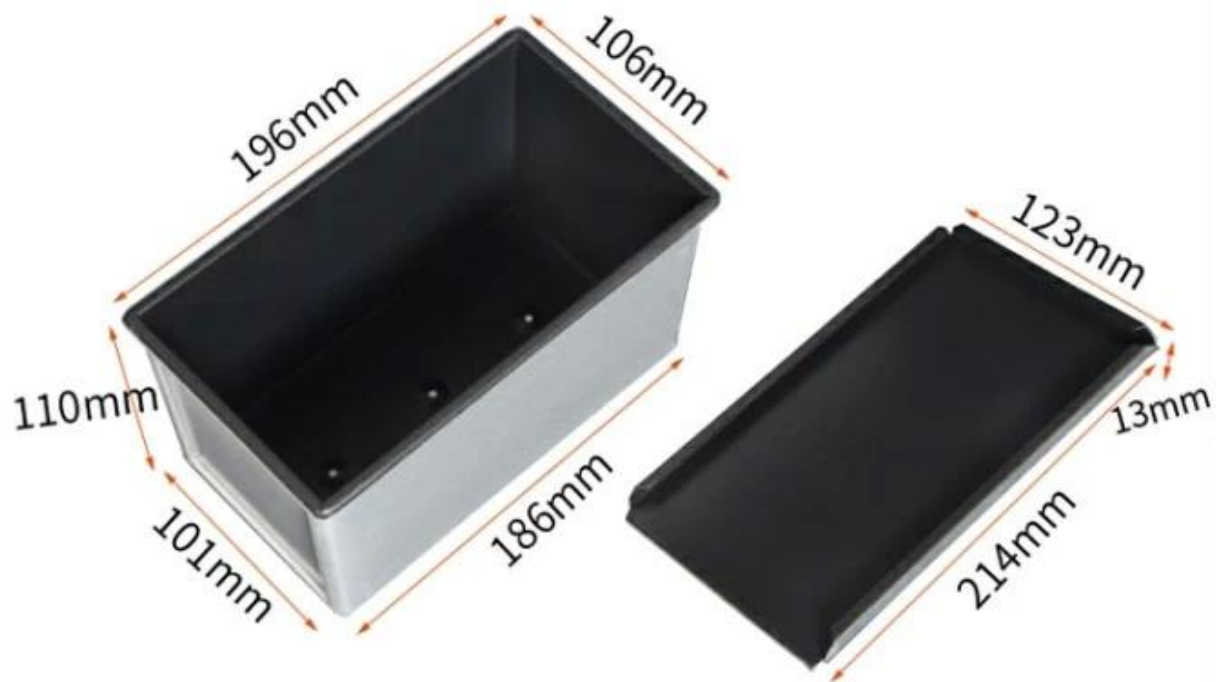

450g Black Nonstick
corrugated surface

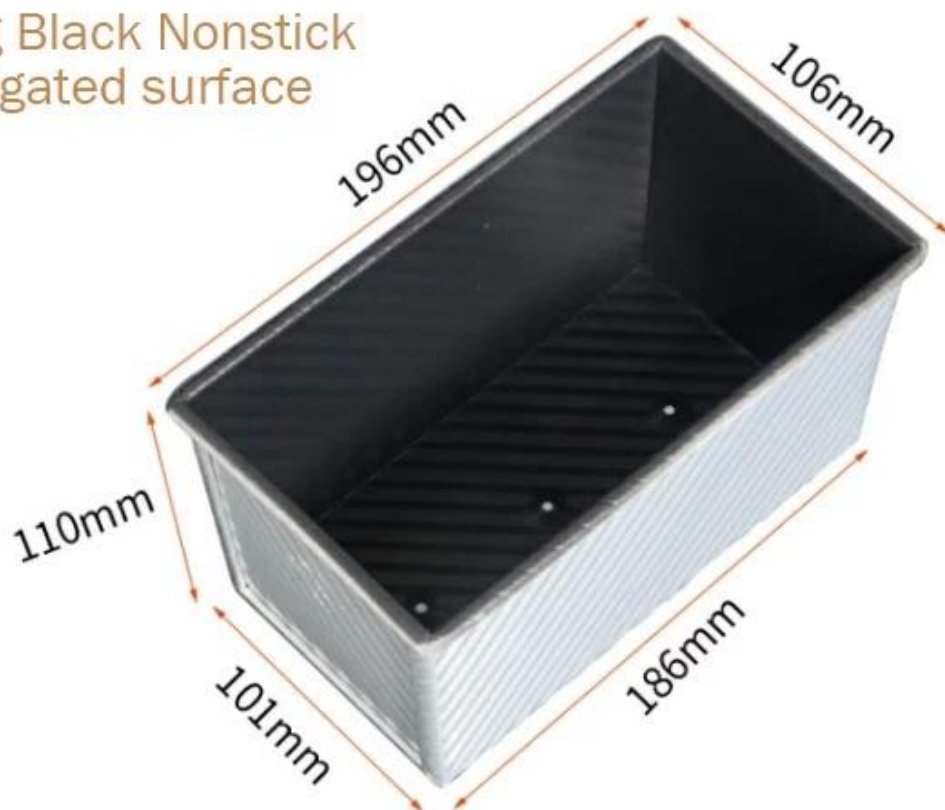



Good Heat Conductivity, baking evenly



Holes at the bottom for better baking effect



Loaf Pans in Application





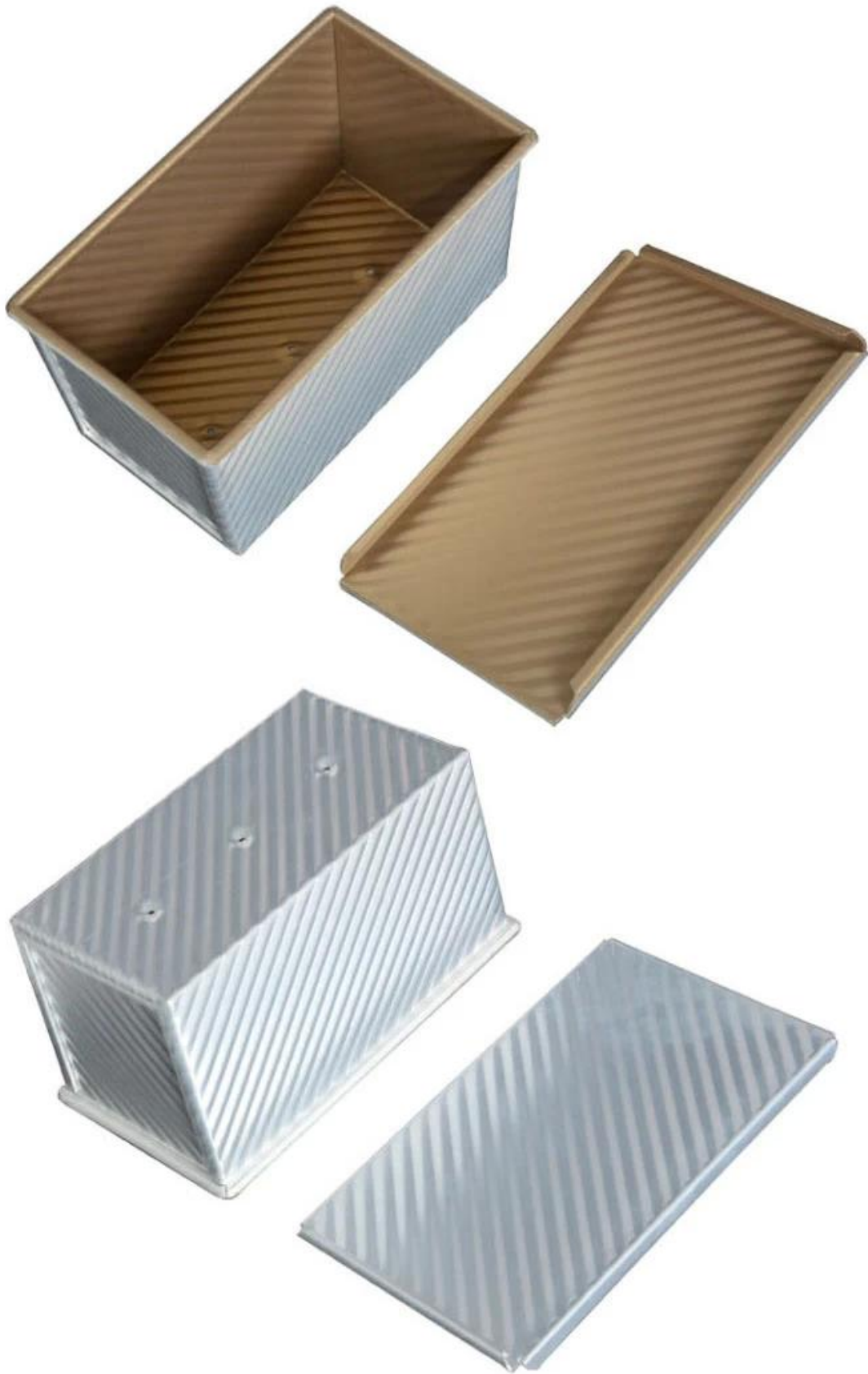

Rolled edge with reinforced wire

Più tipi di padelle per pane e pagnotte per vostra informazione

Ecco altri design per [pagnotta padella all'ingrosso](#).

Le nostre padelle Pullman sono progettate con s Stile semplice, bello e pratico io con conduzione rapida del calore, riscaldamento uniforme, non facile da apparire parziale bruciatura.

Materiale opzionale: alluminio, acciaio alluminato, acciaio inossidabile

Opzioni di perforazione: nessuna perforazione, perforata sul fondo, completamente perforata

Usando la scena: padella per pane singolo, padella per pane con cinturino

Opzioni di superficie: liscia, ondulata, senza rivestimento, Teflon antiaderente, antiaderente in silicone

Dimensione: qualsiasi dimensione

Coperchio: con coperchio o meno come requisito.

customized single loaf pan





Costume la produzione di teglie per pane con cinturino è uno dei nostri più grandi punti di forza, benvenuto per maggiori informazioni.

Ci occupiamo della produzione di prodotti da forno da oltre 12 anni e forniamo migliaia di prodotti da forno a clienti internazionali. Utilizzando la nostra cottura pan , puoi facilmente preparare tutti i tipi di cibo delizioso, Chiffon torte, torta di mousse, Libbra torta, torta di formaggio, ecc

More Customized Strap Loaf Pans from Tsingbuy



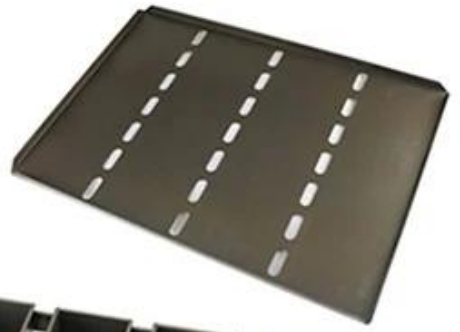



Customized shape
Customized size
Rack matched

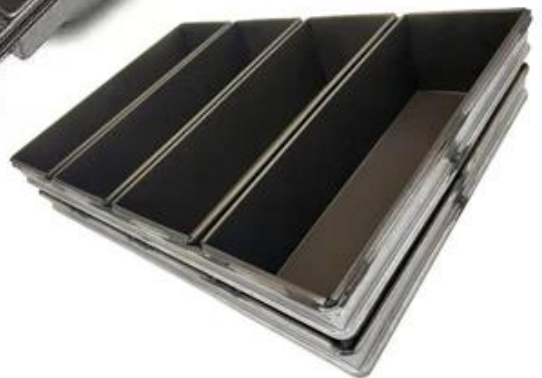

Customized Single Loaf Pan

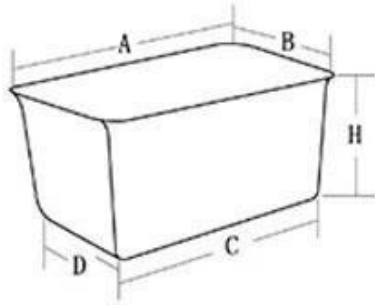

- A.Top length of the item
- B.Top width of the item
- C.Bottom length of the item
- D.Bottom width of the item
- H.Height

Customized Strapped Loaf Pan Sets

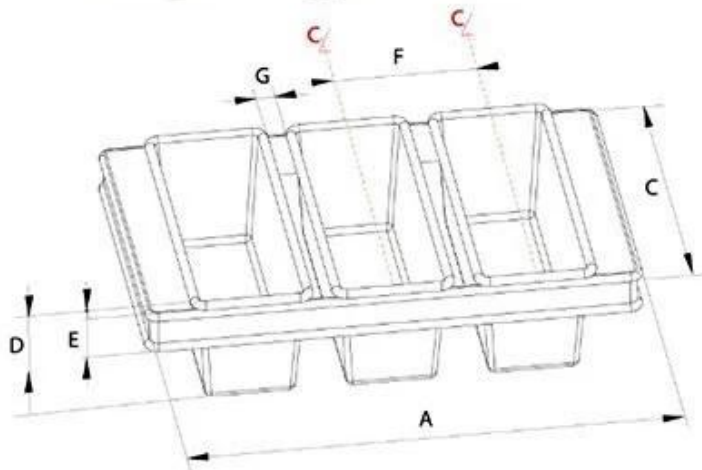

- A.Overall Length
- C.Overall Width
- D.Depth
- E.Frame Height
- F.Center-to-center
- G.Pan Distance



Flat handle



Frame handle



no handle

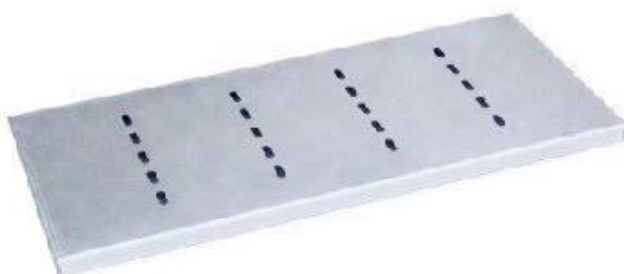

Matching lid (Drop Style)

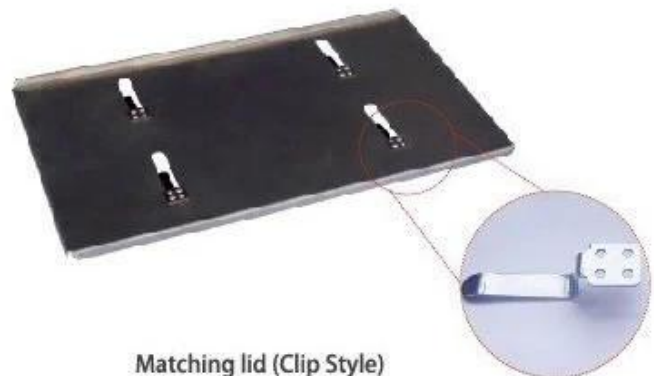

Matching lid (Clip Style)

[Pane & pagnotte](#) immagini di fabbrica



Loaf Pan

Tsingbuy Industry Limited

