

# **Wholesale 900g 1000g 1200g Large Non Stick Aluminum Pullman Loaf Pan Bread Tin Baking Pans with Lid**

## **Main features of gold color non stick aluminum pullman loaf pans bread tin**

1. made of 1.0mm thick aluminum alloy, durable for long service life.
2. food-safe non-stick surface is not sticky, easy to demould, easy to clean
3. designed with cover, it is convenient to make American toast with flat sides. The corrugated surface makes it more convenient to demould.
4. The bottom hole is optional for better circulation of hot air and uniform heating.
5. Wire in rim design makes it more durable and not easy to deformation for long service life.
6. Multiple function for making sandwiches, toast, traditional loaf breads etc.
7. Tsingbuy [aluminum loaf pans manufacturer](#) provides professional ODM&OEM service, with over 15 years in manufacturing commercial baking pans for the international market.

## **Product images of gold color non stick aluminum pullman loaf pans bread tin**



900g loaf pan

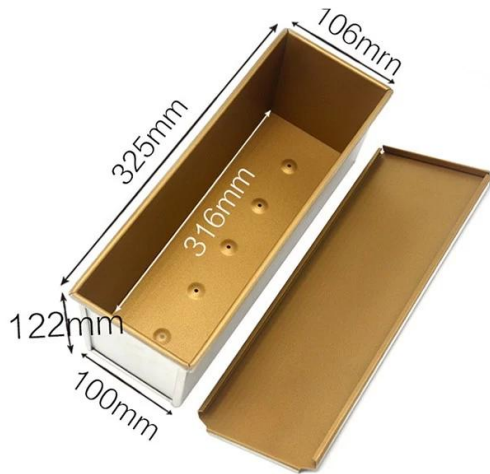

1000g loaf pan

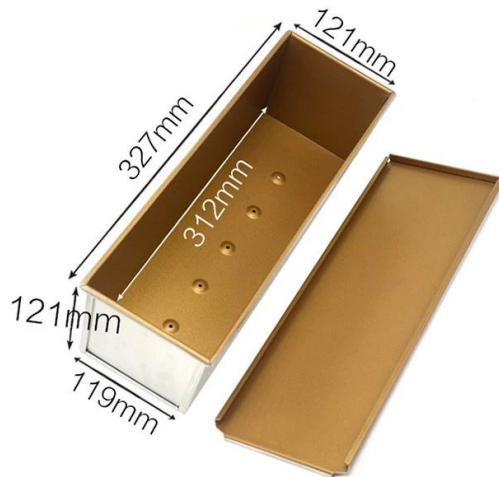

1200g loaf pan

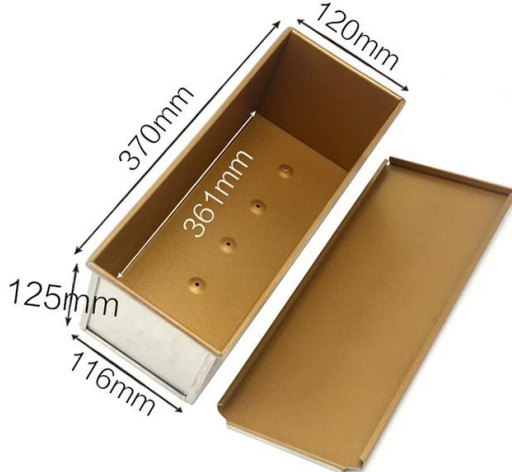





900g loaf pan



1000g loaf pan



1200g loaf pan

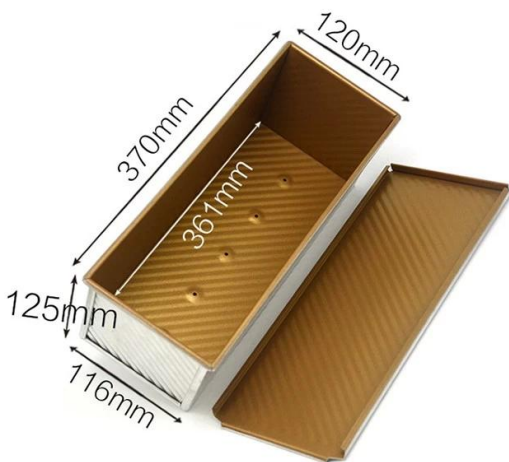



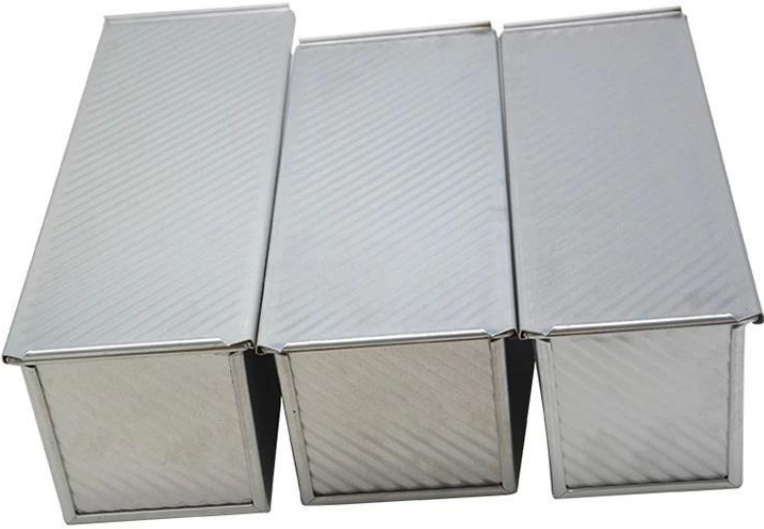





## More types of bread & loaf pans for your information

Here are more designs for bread loaf pans.

Our Pullman loaf pans is designed with simple style, beautiful and practical with fast heat conduction, even heating, not easy to appear partial scorch.

Material optional: aluminum, aluminized steel, stainless steel

Perforation options: no perforation, bottom-perforated, all-perforated

Using scene: single loaf pan, strap loaf pan

Surface options: smooth, corrugated, no-coating, Teflon non-stick, silicone non-stick

Size: any size

Lid: with lid or not as your requirement.

### customized single loaf pan





Material:

Aluminum alloy

Aluminized steel

Besides [wholesale pullman loaf pan with lid](#), ODM&OEM service of sheet pan, baguette pan, multi-mould cupcake pan, strap loaf pan is also one of our biggest strength, welcome for more info.

We have engaged in bakeware manufacturing for over 12 years and has been supplying thousands of bakeware for international customers. Using our baking pan, you can easily make all kinds of delicious food, Chiffon cakes, mousse cake, Pound cake, cheese cake, etc

## More Customized Strap Loaf Pans from Tsingbuy







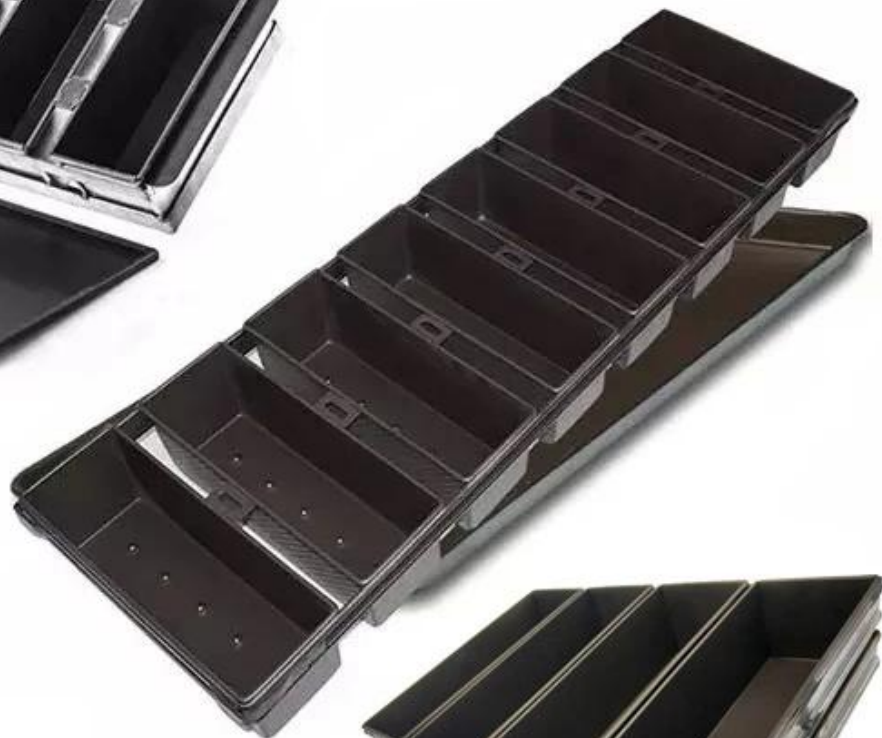

Customized shape  
Customized size  
Rack matched

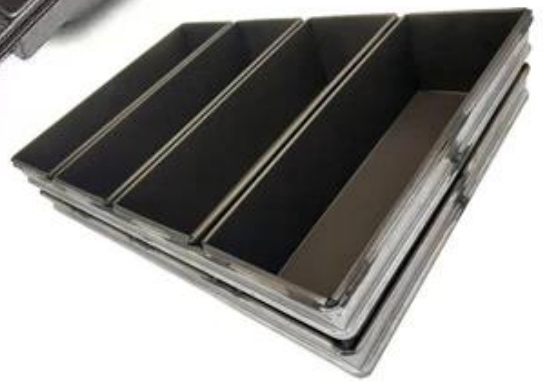



## Customized Single Loaf Pan

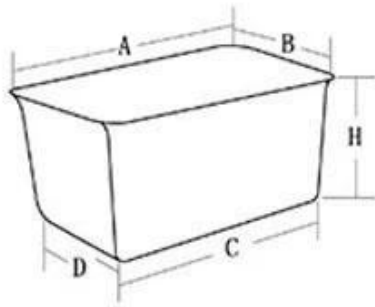

- A. Top length of the item
- B. Top width of the item
- C. Bottom length of the item
- D. Bottom width of the item
- H. Height

## Customized Strapped Loaf Pan Sets

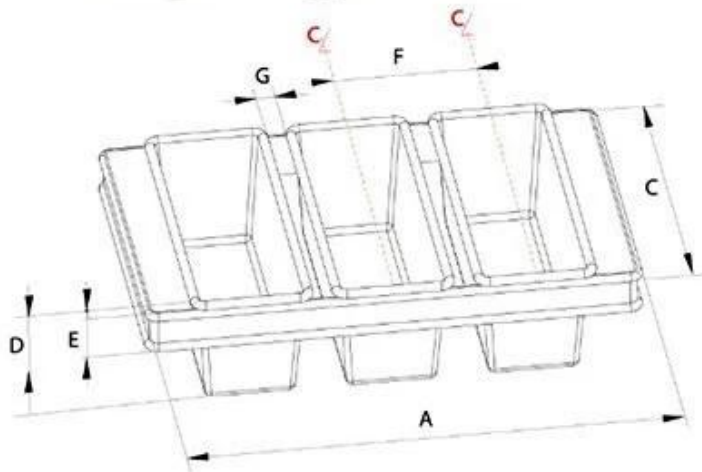

- A. Overall Length
- C. Overall Width
- D. Depth
- E. Frame Height
- F. Center-to-center
- G. Pan Distance



Flat handle



Frame handle



no handle

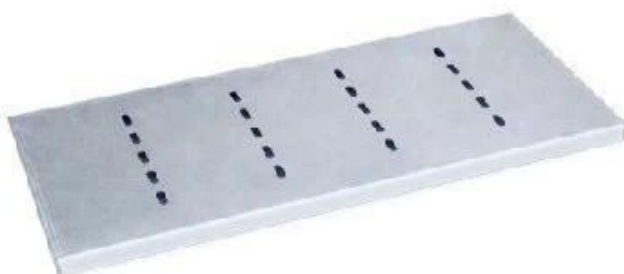

Matching lid (Drop Style)

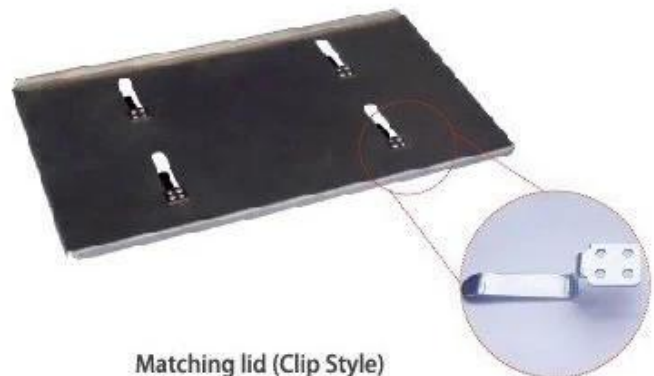

Matching lid (Clip Style)

## Factory pictures

Tsingbuy [bread tin supplier](#) also produces sheet pan, loaf pan, baguette pan, cupcake baking pan, cake pan etc for bakeries, food factories, restaurants for commercial use. ODM&OEM service is our greatest strength. Welcome to contact us if you are looking for commercial baking pans.



### Loaf Pan

Tsingbuy Industry Limited



