

Custom Made Heavy Duty Durable Aluminized Steel Strap Loaf Pan Toast Bread Baking Tin Molds for Commercial and Industrial Use

Main features of custom made aluminized steel strap loaf pan toast bread baking tins

1. Crafted from 0.8/1.0/1.2/1.5 heavy gauge aluminized steel with double strengthening bars over the whole pan.
2. Capable of baking 3/4/5/6/8 loaves quickly while still maintaining the quality of loaf bread baking.
3. Available in a range of sizes, in configurations to suit all industrial/commercial ovens.
4. Coated with PTFE/Silicone glaze to ensure good loaf bread appearance, not sticking to the pan. The non stick coating is suitable for contact with food and has longer-lasting performance. It also reduces the oil when baking and saves your cleaning time and labor.
4. Tsingbuy [aluminized steel loaf pan manufacturer](#) provides "design-sample confirmation-batch production" service with more than 15 years of ODM&OEM experience.

Product images of custom made aluminized steel strap loaf pan toast bread baking tins

Tsingbuy is professional in making both single loaf pan and strap loaf pans. Here we share some models of strap loaf pan for your reference. Most of the strap loaf pans are custom designed according to requirements.

More Customized Strap Loaf Pans from Tsingbuy



Customized Single Loaf Pan

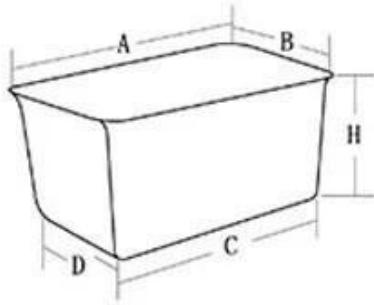

- A. Top length of the item
- B. Top width of the item
- C. Bottom length of the item
- D. Bottom width of the item
- H. Height

Customized Strapped Loaf Pan Sets

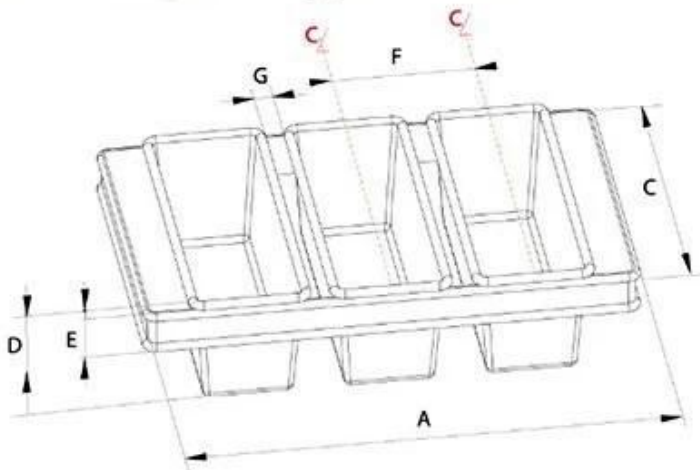

- A. Overall Length
- C. Overall Width
- D. Depth
- E. Frame Height
- F. Center-to-center
- G. Pan Distance



Flat handle



Frame handle



no handle

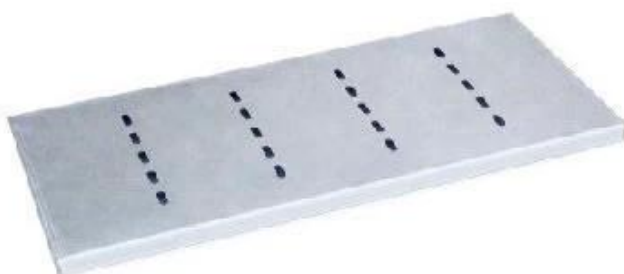

Matching lid (Drop Style)

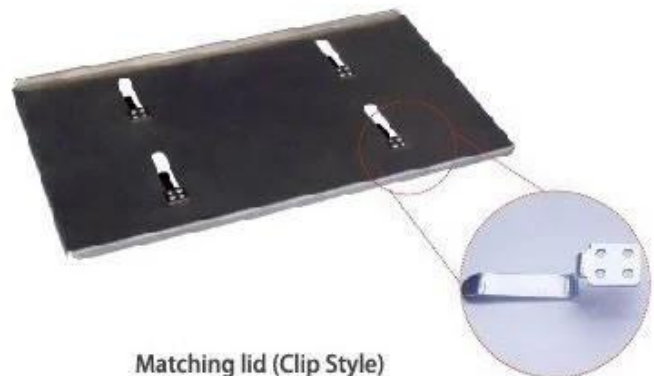

Matching lid (Clip Style)

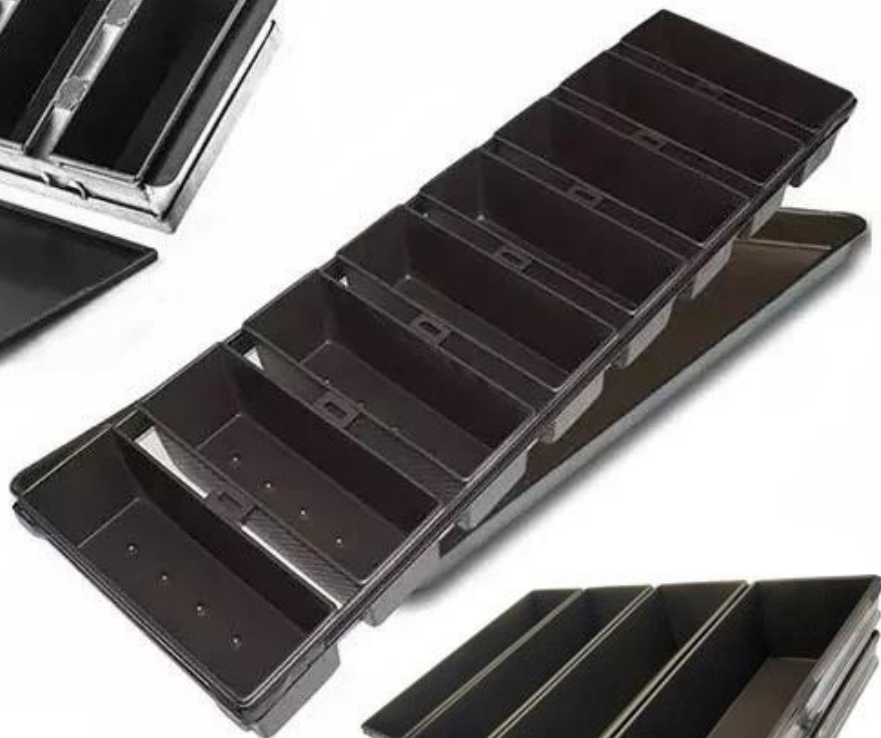

Customized shape
Customized size
Rack matched

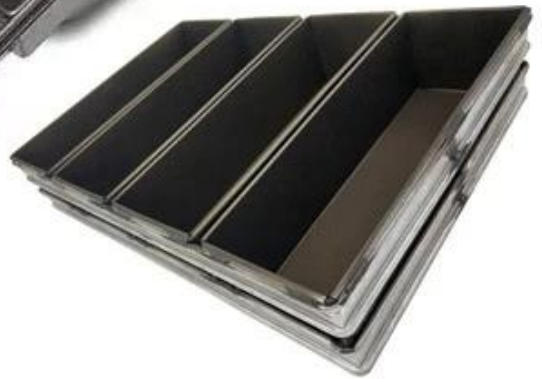

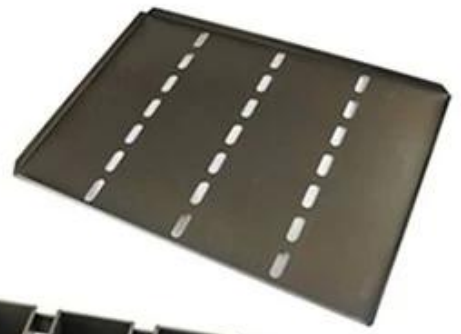

Procedures for custom made loaf baking pans

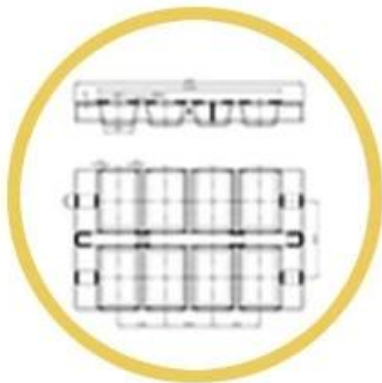

1. DRAWING



2. DESIGN



3. PRODUCT



6. SHIPPING



5. LOADING



4. PACKING

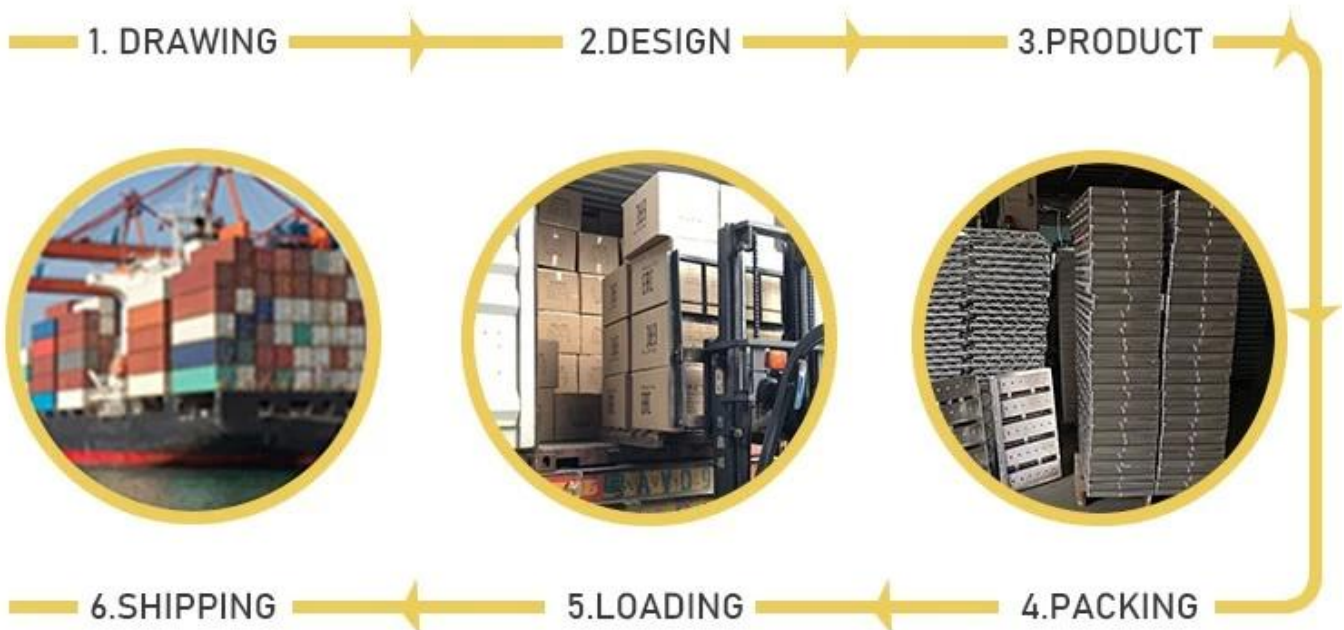



**Custom Made
Strap Loaf Pan
Used with
Bakery Trolley**

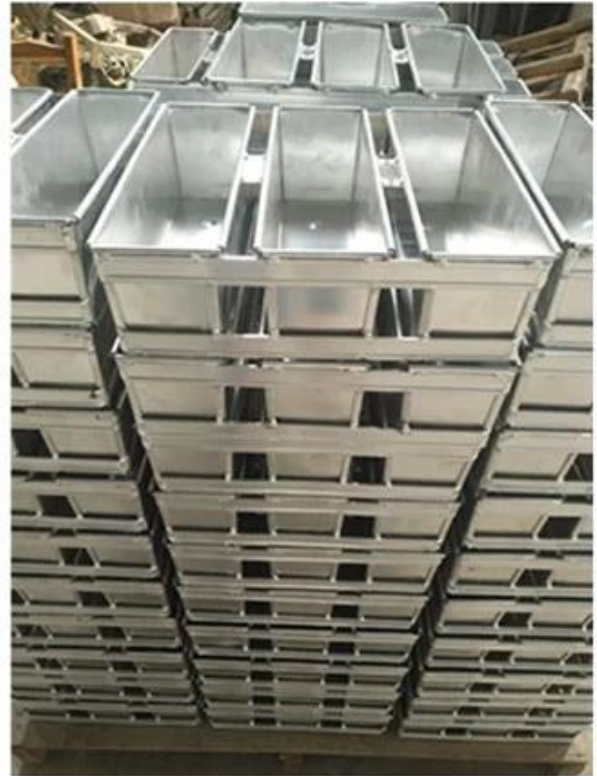

More types of single bread loaf baking pan for home kitchen, bakery, restaurant etc

Here are some classic models of single loaf bread baking pan from Tsingbuy [bread tin supplier](#).

Single Loaf Pan



natural surface



corrugated



full perforation



nonstick



corrugated



golden color



holes at bottom



full perforation



custom size







Besides [China loaf tin wholesale](#), Tsingbuy bakeware manufacturer also provides custom design and wholesale of other commercial bakeware, such as sheet pans, baguette pans, loaf pans, multi-mould baking pans, bakery trolley, cake pans etc. Welcom to consult us at any time.

