

Heavy Duty Aluminized Steel 8 Strap Loaf Pan with Nonstick Surface and Holes at the bottom

Main features of aluminized steel 8 strap loaf pan set toast bread baking tin set

1. Made of high qualified aluminized steel material, good heat conductivity, food-safe and strong durability.
2. Folded construction with reinforced wire support in each pocket, stable and not warp being heated
3. Extra reinforced bar around all pockets provides superior strength and make the whole body more durable
4. The custom design in size makes them suitable for machinery food-production lines, available in oven configurations for greater efficiency
5. The customized strap loaf pan has simple-to-use drop-on cover which can be buckled to be fixed and also has reinforced bars.
6. Tsingbuy [loaf pan manufacturer](#) has more than 12 years experience and ensures you high-qualified product with excellent performance.

Product images for aluminized steel 8 strap loaf pan toast bread baking tin set







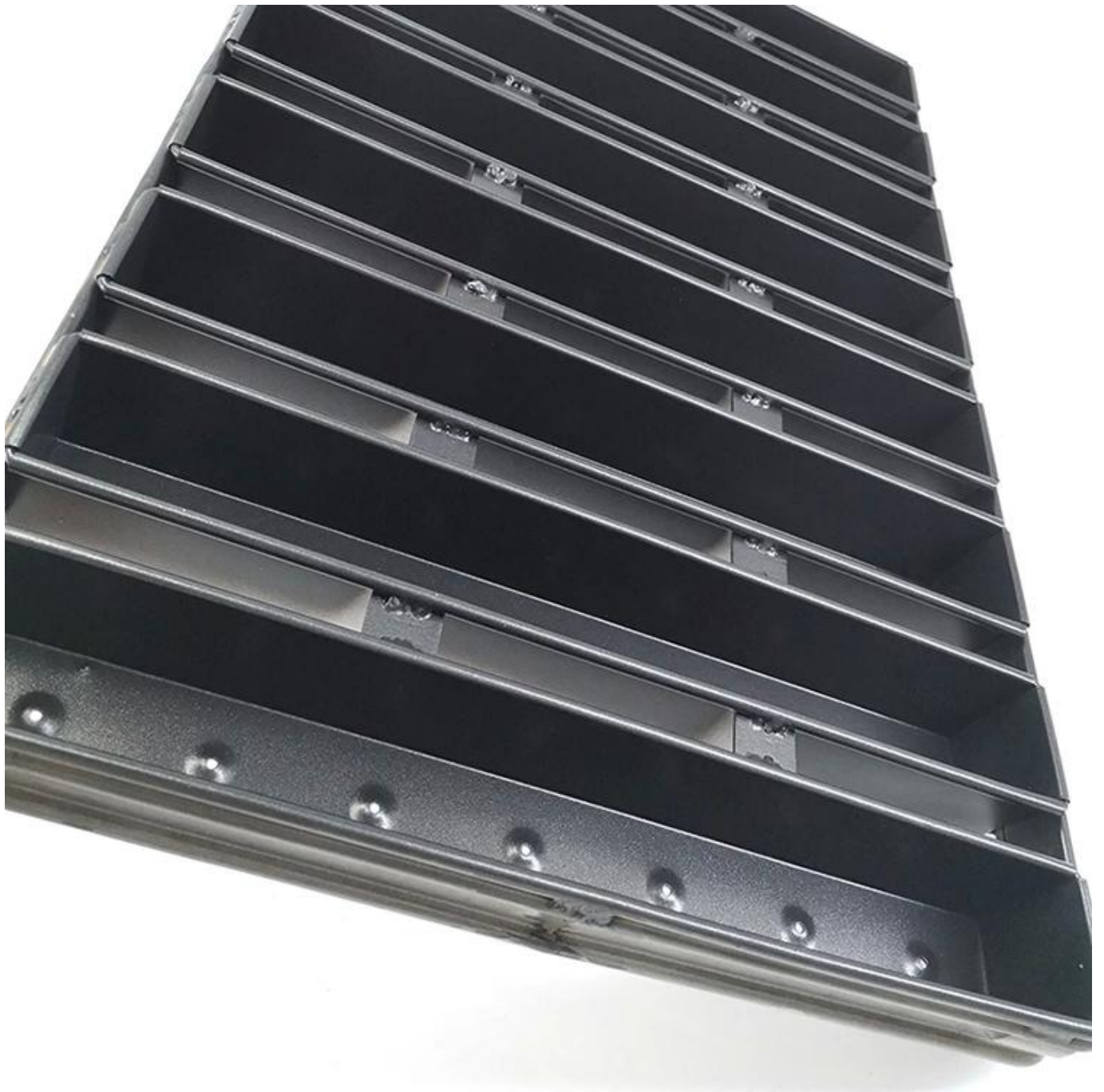

More type of strap loaf pan for your information

Here are some pictures of SINGLE loaf pans and STRAP loaf bread pans from Tsingbuy [commercial loaf pan supplier](#).

customized single loaf pan



Teflon coating

Silicone coating



Material:

Aluminum alloy

Aluminized steel



More Customized Strap Loaf Pans from Tsingbuy



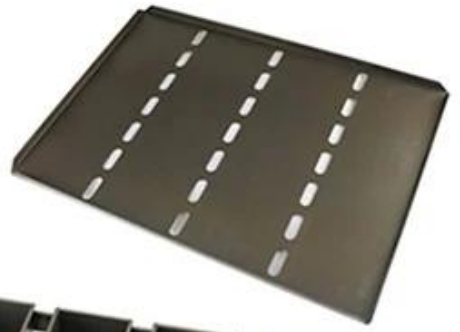

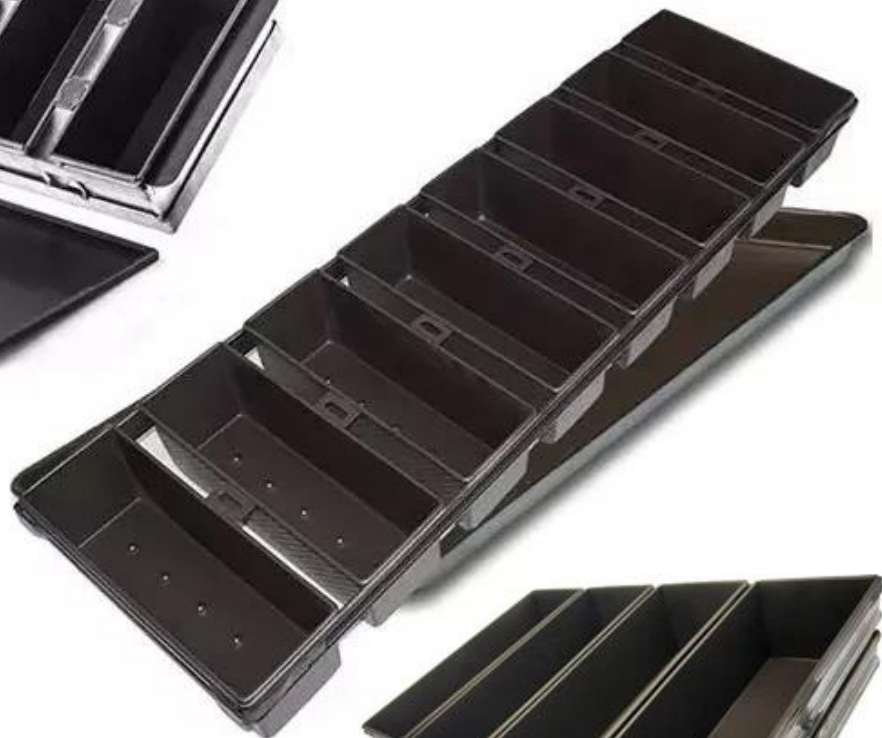

Customized shape
Customized size
Rack matched

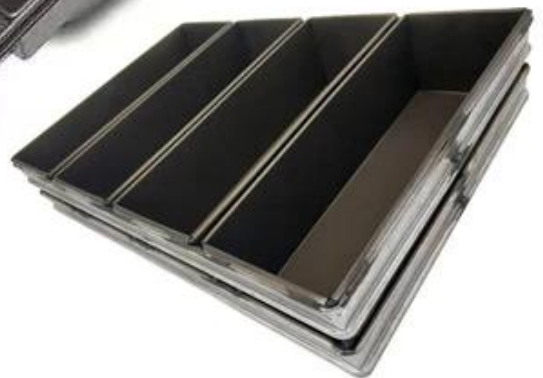

Customized Single Loaf Pan

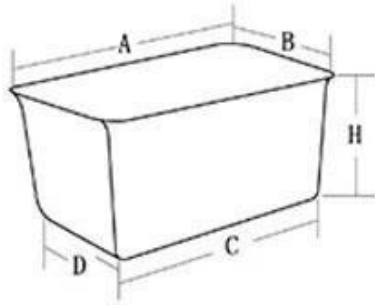

- A.Top length of the item
- B.Top width of the item
- C.Bottom length of the item
- D.Bottom width of the item
- H.Height

Customized Strapped Loaf Pan Sets

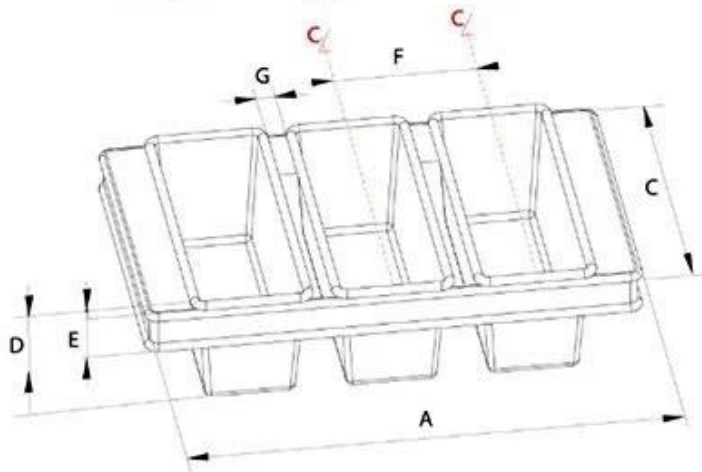

- A.Overall Length
- C.Overall Width
- D.Depth
- E.Frame Height
- F.Center-to-center
- G.Pan Distance



Flat handle



Frame handle



no handle



Matching lid (Drop Style)

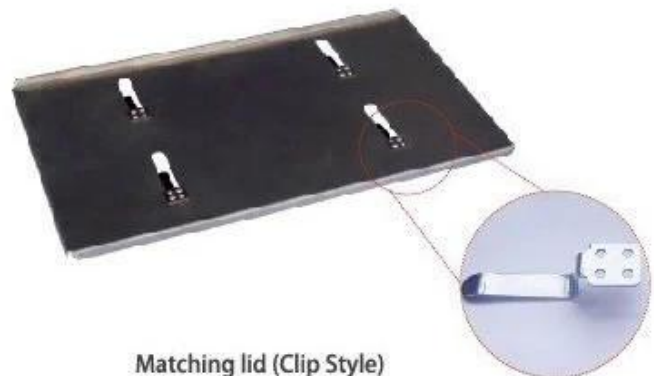

Matching lid (Clip Style)

Contact us



Zoe Lee

TSINGBUY INDUSTRY LIMITED FACTORY PLANET
OEM & ODM - Bakeware and Customization



Tel

+86 186 1186 6087

+86 0755-85234769



Email

marketing@tsingbuy.com



Skype

+86 186 1186 6087



Whatsapp

+86 186 1186 6087



Web

www.chinabakeware.com



ADD

2 Floor B1 Building, No 22 Dafu Industry
park, Guanlan, Longhua District, Shenzhen, China 518110