

304 Inox Sacier Moules à gâteau en forme de coeur en forme d'anneau de mousse pour la cuisson

Principales caractéristiques de en forme de coeur m acier inoxydable Moules à gâteau en forme d'anneau de mousse

Acier inoxydable 304 de haute qualité

Tsingbuy [usine de bagues en mousse](#) applique h matériau en acier inoxydable de haute qualité, qui peut entrer directement en contact avec les aliments, sûr à utiliser, à haute résistance, pas facile à déformer, pas facile à rouiller et excellent résistant à la corrosion.

Conception de bord roulé

Conception spéciale de bord de curling à la fois supérieur et inférieur, pas de grattage, facile à prendre et à placer

La perforation sur l'acier inoxydable est facultative

La surface perforée est bonne pour un chauffage uniforme et rapide pour la dissipation de la chaleur. Vous pouvez choisir d'être perforé selon vos besoins.

Différentes formes et plusieurs tailles pour les options

Rond, ovale, carré, rectangle, cœur, hexagone et de nombreuses autres formes sont facultatifs, créant librement des œuvres d'art gastronomiques.

Photos de s en forme de coeur acier inoxydable Moules à gâteau en forme d'anneau de mousse





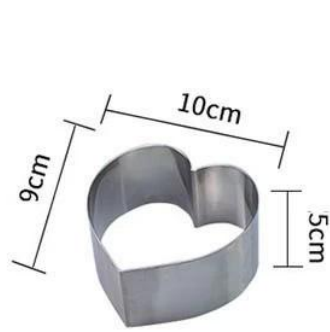

4 inch

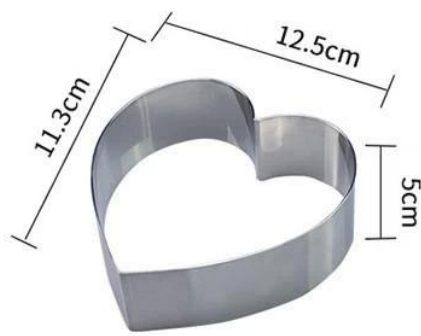

5 inch

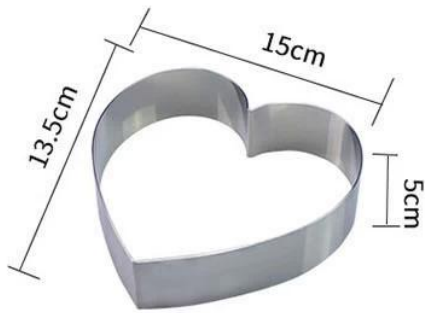

6 inch

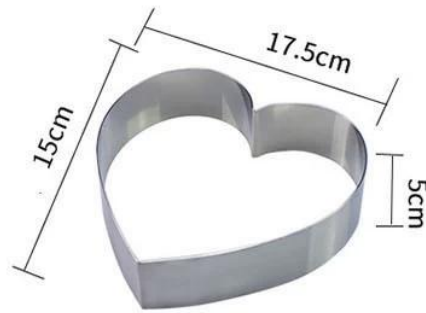

7 inch

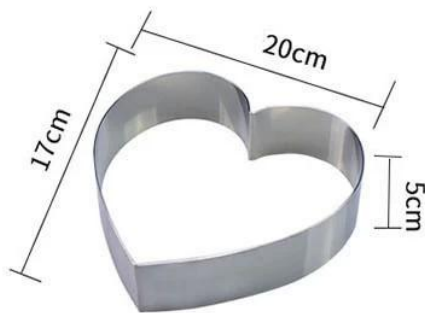

8 inch

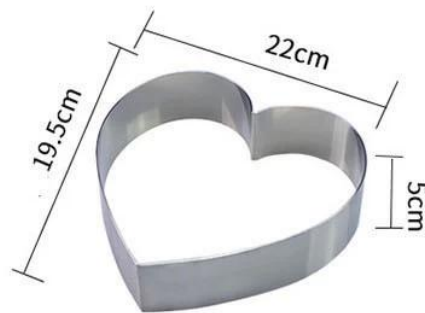

9 inch

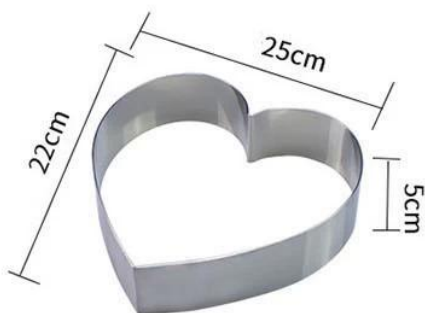

10 inch







Autres moules à gâteaux qui pourraient vous intéresser

Voici plus de moules à gâteaux de Tsingbuy [fabricant de moules à gâteaux](#) . Que vous recherchiez un moule à gâteau de cuisson ordinaire ou que vous recherchiez un moule à gâteau sur mesure, n'hésitez pas à venir chez nous.



Non-stick Coated Cake Pans



Anodized Surface



Custom Size



Custom Design





non-stick coated

**Fixed bottom
Square
Rectangular**



anodized surface



Detachable / removable bottom







Spectacle d'usine

Outre [vente en gros moules à gâteaux coeur](#), le fabricant d'ustensiles de cuisson Tsingbuy fournit également des moules à gâteaux en aluminium, des plateaux en aluminium, un moule à baguette en aluminium, un moule à pain, des moules à cupcake multi-moules, etc., ainsi qu'un service ODM & OEM de fournitures de boulangerie. Bienvenue à nous contacter à tout moment.

Production Machines



Automatic cutting machine



Automatic punching machine



Punching machine



Bending machine



Sand blasting machine



Drying machine

Our Advantages



Professional machine



Standard production flow



Experienced workers



Clean & tidy warehouse



Quick production fast dispatch

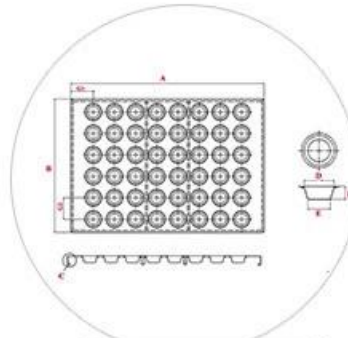

ODM & OEM service