

# Moules en étain de cuisson de pain de pain de pain de pain de courroie d'acier aluminisé durable résistant fait sur commande pour l'usage commercial et industriel

## **Principales caractéristiques des moules à pain en acier aluminisé sur mesure**

1. Fabriqué à partir de 0,8/1,0/1,2/1,5 acier épais aluminisé avec doubles barres de renforcement sur tout le plat.
2. Capable de cuire 3/4/5/6/8 pains rapidement tout en maintenant la qualité de pain cuisson.
3. Disponible dans une gamme de tailles, dans configurations convenant à tous fours industriels/commerciaux.
4. Enduit de PTFE/Silicone glaçure pour assurer une bonne miche pain apparence, ne collant à la poêle.  
Le revêtement non adhérent convient au contact avec les aliments et a une performance durable plus longtemps. Il également réduit la huile lors de la cuisson et économise votre temps de nettoyage et de travail.

4. Tsingbuy [fabricant de moules à pain en acier aluminisé](#) fournit un service de conception-échantillon confirmation-lot production avec plus puis 15 ans d'expérience ODM et OEM .

## **Images de produits de moule à pain en acier aluminisé sur mesure moules à pain grillé**

Tsingbuy est professionnelle dans fabrication tous les deux Célibataire miche de pain poêle et sangle miche de pain des casseroles. Ici nous partager quelques modèles de moule à pain à sangle pour votre référence. La plupart des moules à pain à sangle sont conçus sur mesure en fonction des besoins.

## More Customized Strap Loaf Pans from Tsingbuy



## Customized Single Loaf Pan

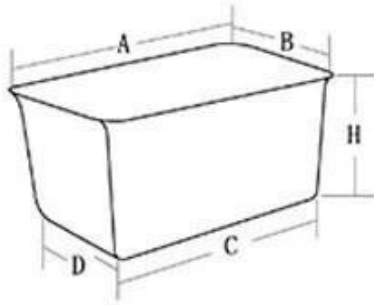

- A.Top length of the item
- B.Top width of the item
- C.Bottom length of the item
- D.Bottom width of the item
- H.Height

## Customized Strapped Loaf Pan Sets

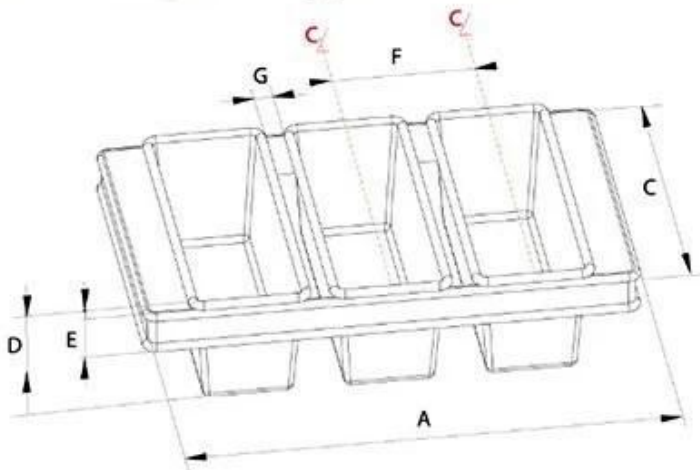

- A.Overall Length
- C.Overall Width
- D.Depth
- E.Frame Height
- F.Center-to-center
- G.Pan Distance



Flat handle



Frame handle



no handle



Matching lid (Drop Style)

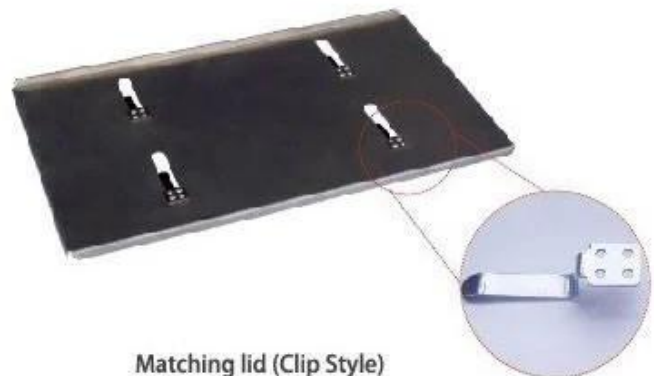

Matching lid (Clip Style)



Customized shape  
Customized size  
Rack matched

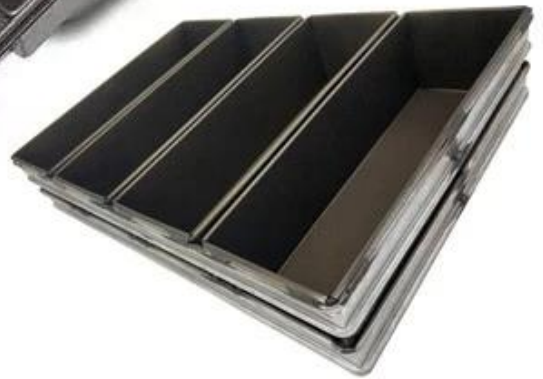

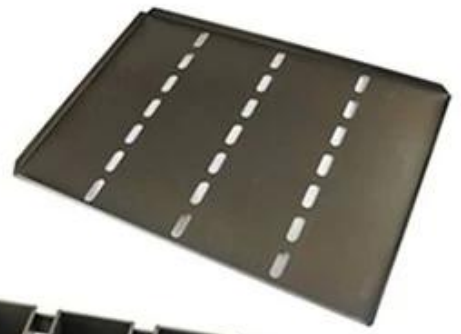



## Procedures for custom made loaf baking pans

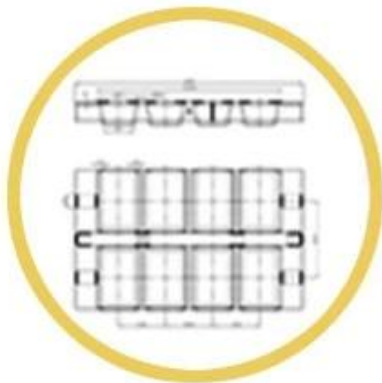

1. DRAWING



2. DESIGN



3. PRODUCT



6. SHIPPING



5. LOADING



4. PACKING



## Custom Made Strap Loaf Pan Used with Bakery Trolley

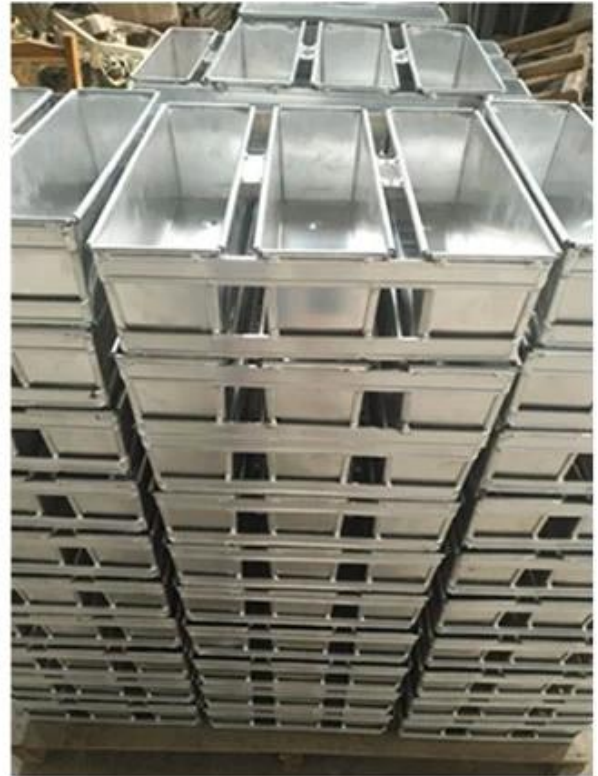

**Plus de types de moules à pain simples pour la cuisine à domicile, la boulangerie, le restaurant, etc.**

Voici quelques modèles classiques de moule à pain à pain de Tsingbuy [fournisseur de moules à pain](#).

# Single Loaf Pan



natural surface



corrugated



full perforation



nonstick



corrugated



golden color



holes at bottom



full perforation



custom size









Outre [Vente en gros de moules à pain en Chine](#), le fabricant d'ustensiles de cuisson Tsingbuy fournit également la conception personnalisée et la vente en gros d'autres ustensiles de cuisson commerciaux, tels que des plaques de cuisson, des moules à baguette, des moules à pain, des moules à plusieurs moules, des chariots de boulangerie, des moules à gâteau, etc.

