

304 S inoxidable acero Moldes de anillo de pastel de anillo de mousse en forma de corazón para hornear

Características principales de en forma de corazón acero inoxidable moldes de anillo de pastel de anillo de mousse

Acero inoxidable 304 de alta calidad.

Si comprar [fábrica de anillos de mousse](#) se aplica el material de acero inoxidable de alta calidad, que puede entrar en contacto directo con los alimentos, seguro de usar, con alta resistencia, no es fácil de deformar, no es fácil de oxidar y excelente resistente a la corrosión.

Diseño de borde enrollado

Diseño especial de borde rizado tanto en el lado superior como en el inferior, sin raspaduras, fácil de tomar y colocar

La perforación en acero inoxidable es opcional

La superficie perforada es buena para un calentamiento uniforme y rápida para la disipación del calor. Puede elegir si se perforará de acuerdo con sus requisitos.

Varias formas y varios tamaños para opciones

Redondo, ovalado, cuadrado, rectangular, corazón, hexágono y muchas otras formas son opcionales, creando libremente obras de arte gourmet.

Imágenes de s en forma de corazón acero inoxidable moldes de anillo de pastel de anillo de mousse





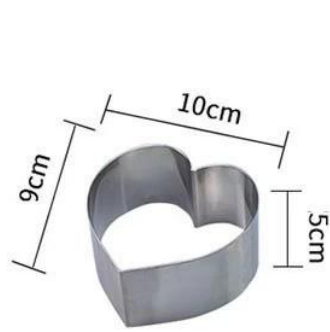

4 inch

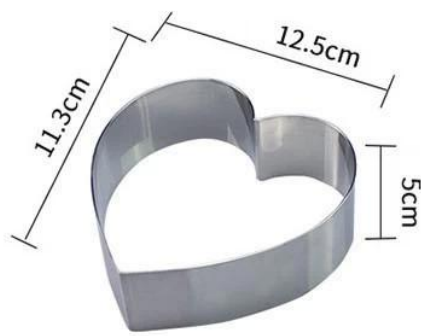

5 inch

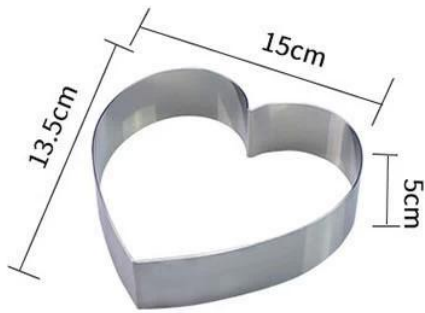

6 inch

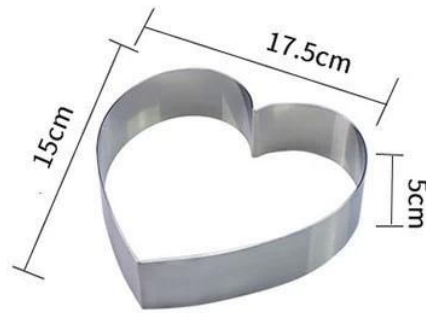

7 inch

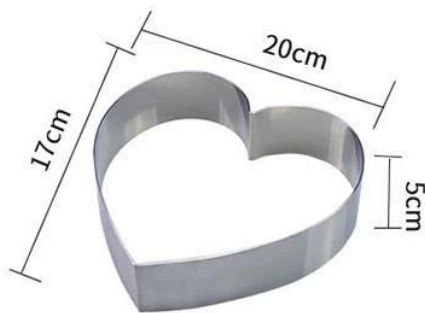

8 inch

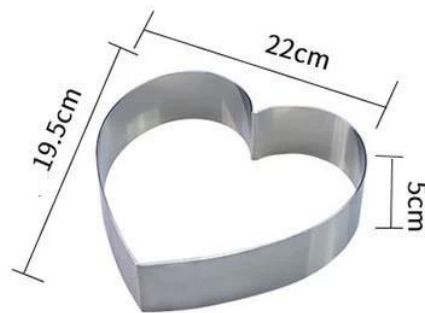

9 inch

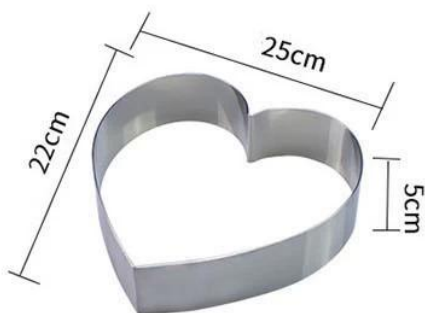

10 inch







Otros moldes para tartas que te pueden interesar

Aquí hay más moldes para hornear pasteles de Tsingbuy [fabricante de moldes para pasteles](#) . Ya sea que esté buscando un molde para hornear pasteles normal o un molde para pasteles hecho a medida, bienvenido a visitarnos.



Non-stick Coated Cake Pans



Anodized Surface



Custom Size



Custom Design



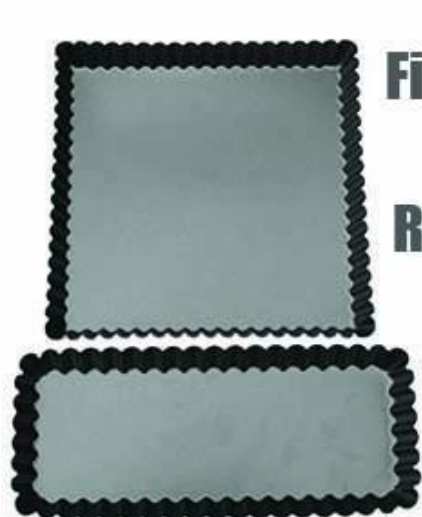

non-stick coated

**Fixed bottom
Square
Rectangular**



anodized surface



Detachable / removable bottom







Espectáculo de fábrica

Además [venta al por mayor moldes de pastel de corazón](#), El fabricante de utensilios para hornear Tsingbuy también ofrece moldes para pasteles de aluminio, bandejas de aluminio, moldes para hornear baguette de aluminio, moldes para pan, moldes para hornear cupcakes de moldes múltiples, etc., así como el servicio ODM y OEM de suministros de panadería. Bienvenido a contactarnos en cualquier momento.

Production Machines



Automatic cutting machine



Automatic punching machine



Punching machine



Bending machine



Sand blasting machine



Drying machine

Our Advantages



Professional machine



Standard production flow



Experienced workers



Clean & tidy warehouse



Quick production fast dispatch

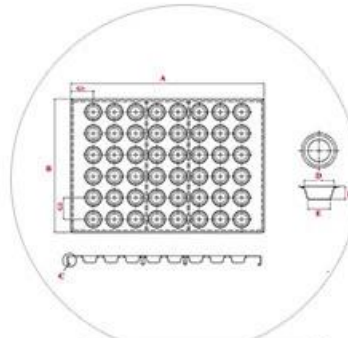

ODM & OEM service