

Juego de moldes de hojalata antiadherente de acero aluminizado para uso industrial, hechos a medida, con correa de 10 cavidades

Características principales del juego de moldes para hornear pan con correa antiadherente de 10 cavidades de acero aluminizado hecho a medida

1. Este molde comercial para hornear pan tiene capacidad para (10) panes, cada caja con un tamaño de 165x80 mm. Este producto le permite producir diez panes para vender o servir rápidamente mientras mantiene la calidad del horneado. Ya sea que necesite hacer panes exclusivos para la cena o panes de temporada, este molde para pan es una buena opción para ayudarlo a terminar su trabajo de horneado fácilmente.
2. Los moldes para pan están fabricados con aluminio de 0,7/1,0/1,2 mm. acero inoxidable con esquinas dobladas dobles, el borde de e cada sartén está equipado con un alambre de borde de 5 mm de diámetro. los marcos se fabrican de aluminizado de 1,2 mm acero inoxidable para un gran soporte y durabilidad. La superficie de los moldes para pan son acabado estriado y vienen con agujeros de vapor. No apto para mezclas sin gluten.
3. Este pan de correa molde para pan está fabricado en Porcelana [fabricante de moldes para pan grande](#) - Tsingbuy Industry Limited. Él está disponible en una gama de tamaños, en varias configuraciones para adaptarse a todos los hornos industriales, comerciales o domésticos.

Imágenes de productos de Juego de moldes para hornear pan con correa antiadherente de 10 cavidades de acero aluminizado hecho a medida







3 pcs



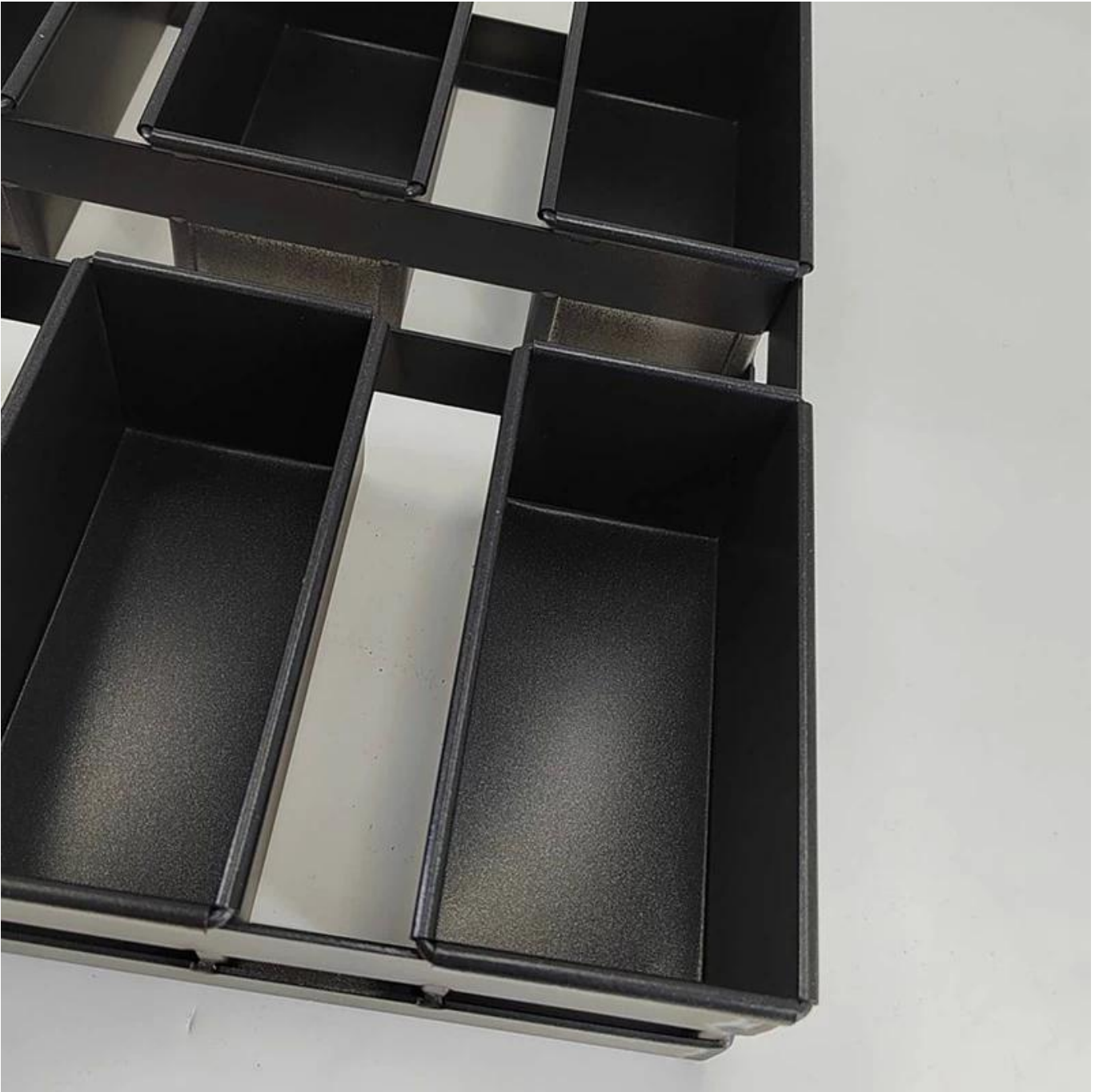



Tsingbuy es profesional en haciendo ambos soltero barra cacerola y Correa barra sartenes Aquí nosotros compartir algunos modelos de molde para pan con correa para su referencia. La mayoría de los moldes para pan con correa se diseñan a la medida de acuerdo con los requisitos.

More Customized Strap Loaf Pans from Tsingbuy



Customized Single Loaf Pan

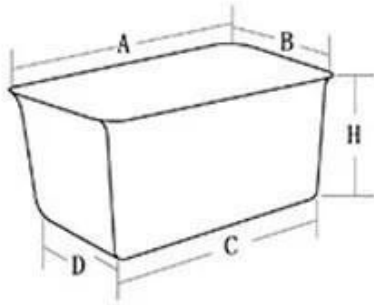

- A. Top length of the item
- B. Top width of the item
- C. Bottom length of the item
- D. Bottom width of the item
- H. Height

Customized Strapped Loaf Pan Sets

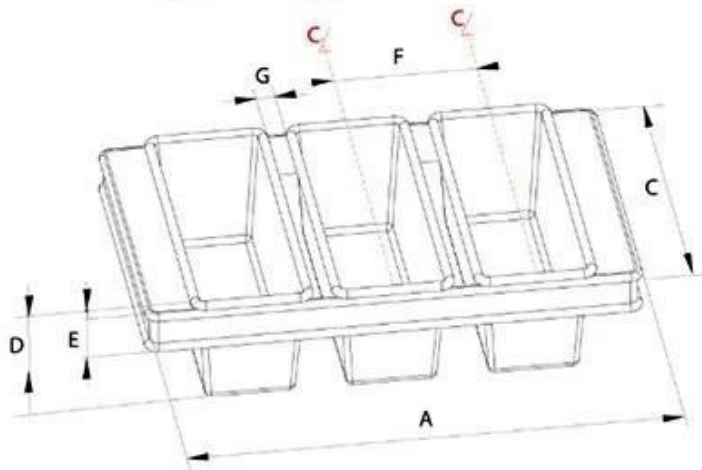

- A. Overall Length
- C. Overall Width
- D. Depth
- E. Frame Height
- F. Center-to-center
- G. Pan Distance



Flat handle



Frame handle



no handle



Matching lid (Drop Style)

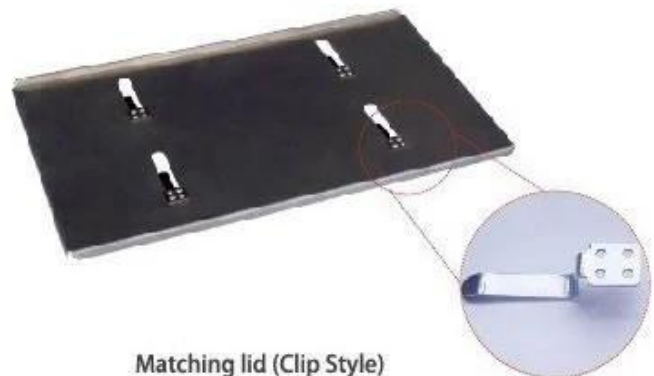

Matching lid (Clip Style)

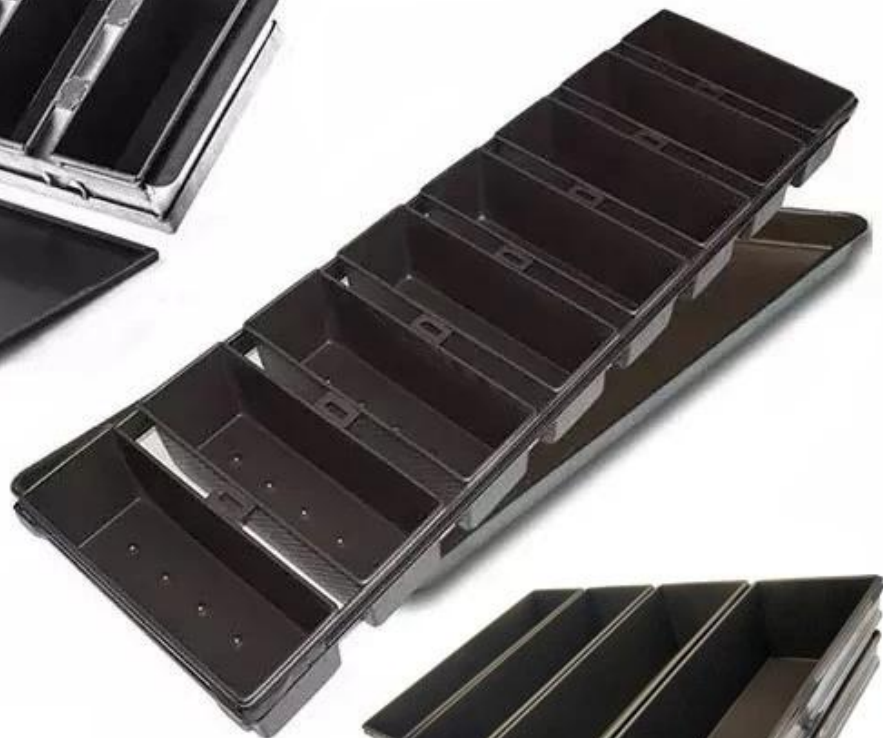

Customized shape
Customized size
Rack matched

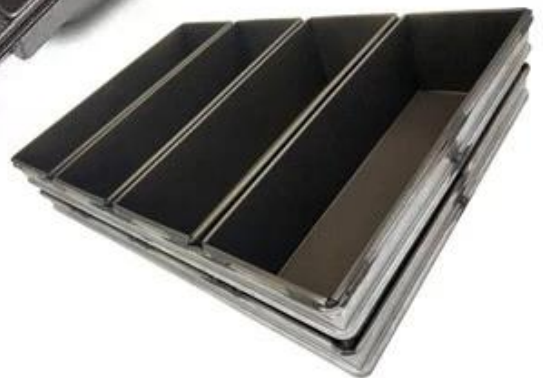

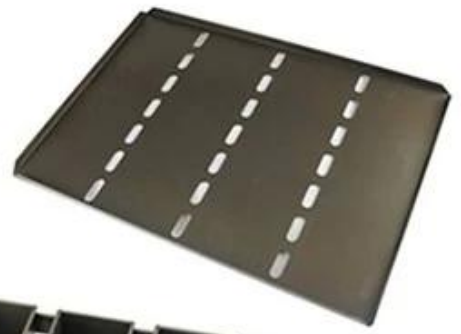

Procedures for custom made loaf baking pans

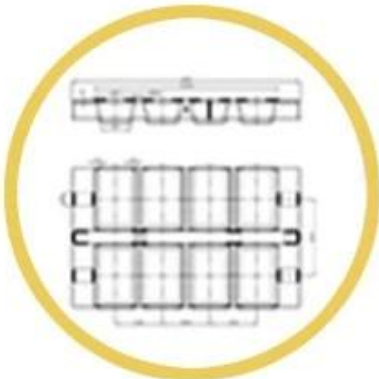

1. DRAWING



2. DESIGN



3. PRODUCT



6. SHIPPING



5. LOADING



4. PACKING

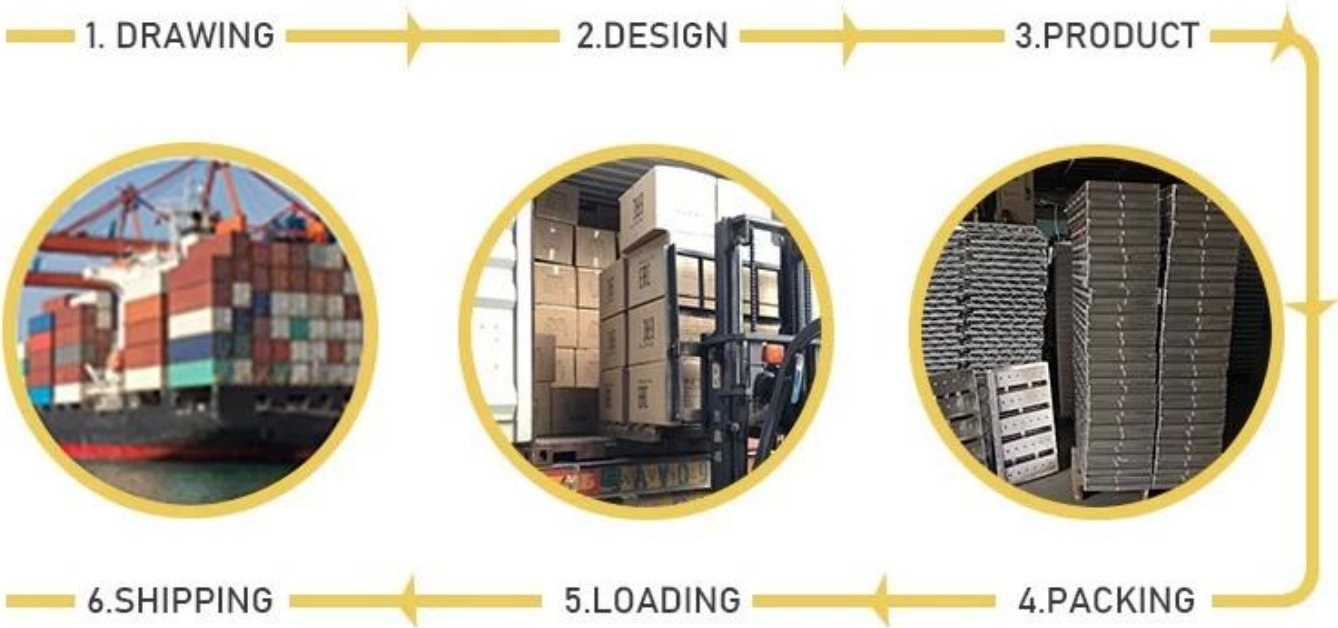



Custom Made Strap Loaf Pan Used with Bakery Trolley



Más tipos de moldes para hornear pan de un solo pan para la cocina del hogar, panadería, restaurante, etc.

Estos son algunos modelos clásicos de bandejas para hornear pan de un solo pan de Tsingbuy [proveedor de moldes para pan antiadherentes](#).

Single Loaf Pan



natural surface



corrugated



full perforation



nonstick



corrugated



golden color



holes at bottom



full perforation



custom size

Imágenes de fábrica del productor de moldes para pan con correa Tsingbuy





Además [molde para pan al por mayor](#)El fabricante de utensilios para hornear Tsingbuy también ofrece diseño personalizado y venta al por mayor de otros utensilios para hornear comerciales, como moldes para láminas, moldes para baguette, moldes para pan, moldes para hornear con múltiples moldes, carrito de panadería, moldes para pasteles, etc. Ult us en cualquier momento.

