

Brot Laib Pan Toast Backform Aluminiumpfanne mit Abdeckung

Hauptmerkmale von Aluminium-Wellbrot-THOAF-Pfanne mit Deckel

- 1 M.ADE von 1,0 mm dick Aluminiumlegierung, Dauerhaft für lange Lebensdauer.
- 2 Food-Safe und Welllat, Wellplätze nicht klebrig, leicht zu demformen, leicht zu reinigen
3. Das Bodenloch ist optional zum Besseren Zirkulation von Heißluft und gleichmäßiger Heizung.
- 4 Draht in RIM-Design macht es dauerhafter und nicht leicht zu einer Verformung für lange SERVICE-Lebens.
- 5 Mehrfachfunktion zum Herstellen von Sandwiches, Toast, traditionellen Laib-Brot usw.
6. ODM & OEM ist in verfügbar Tsingbuy. Fachmann **Pullman Laib Pan Hersteller**.
7. Tsingbuy. [Brot-Laib-Pan-Hersteller](#) hat seit über 12 Jahren benutzerdefinierte Backformen für den internationalen Markt.

Produktbilder von. Wellpappe Brot Backpfanne mit Abdeckung

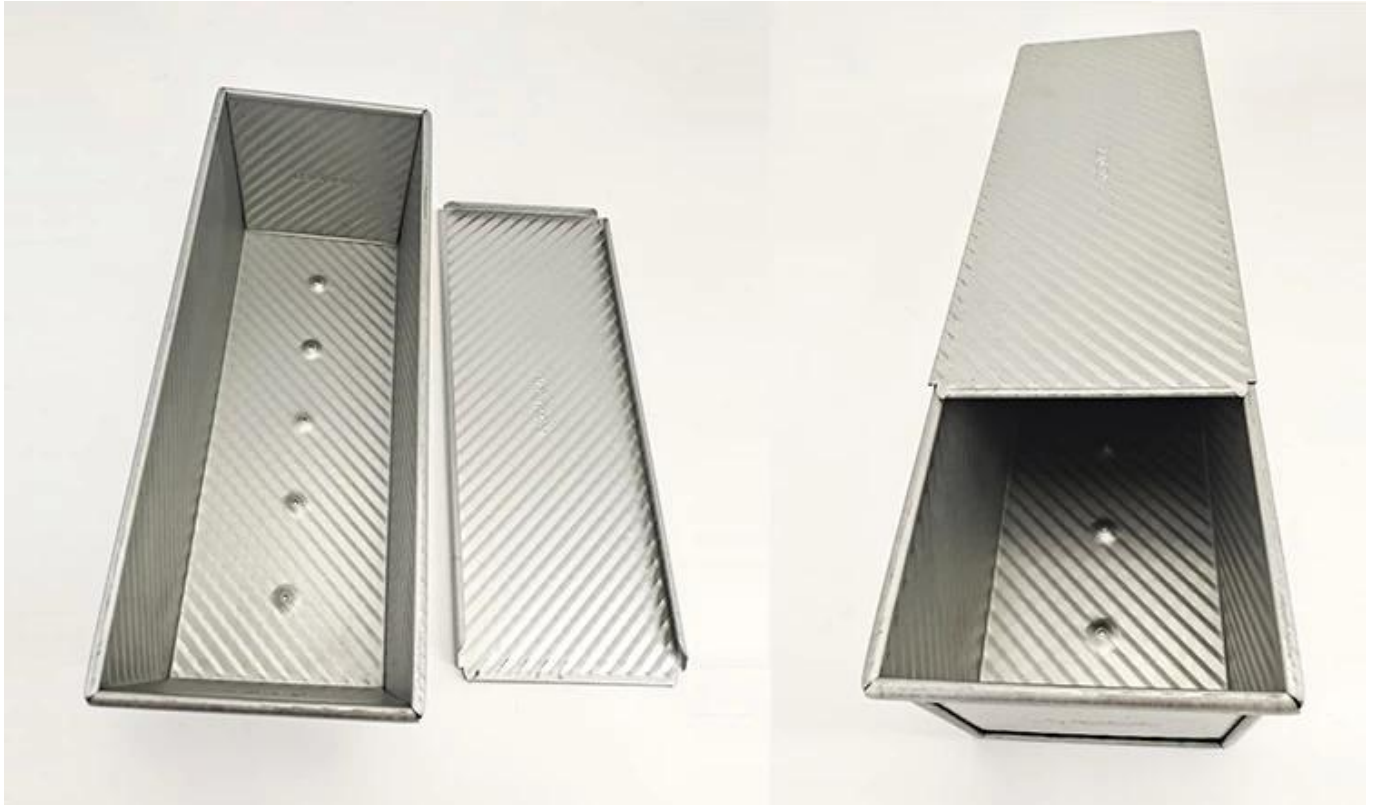





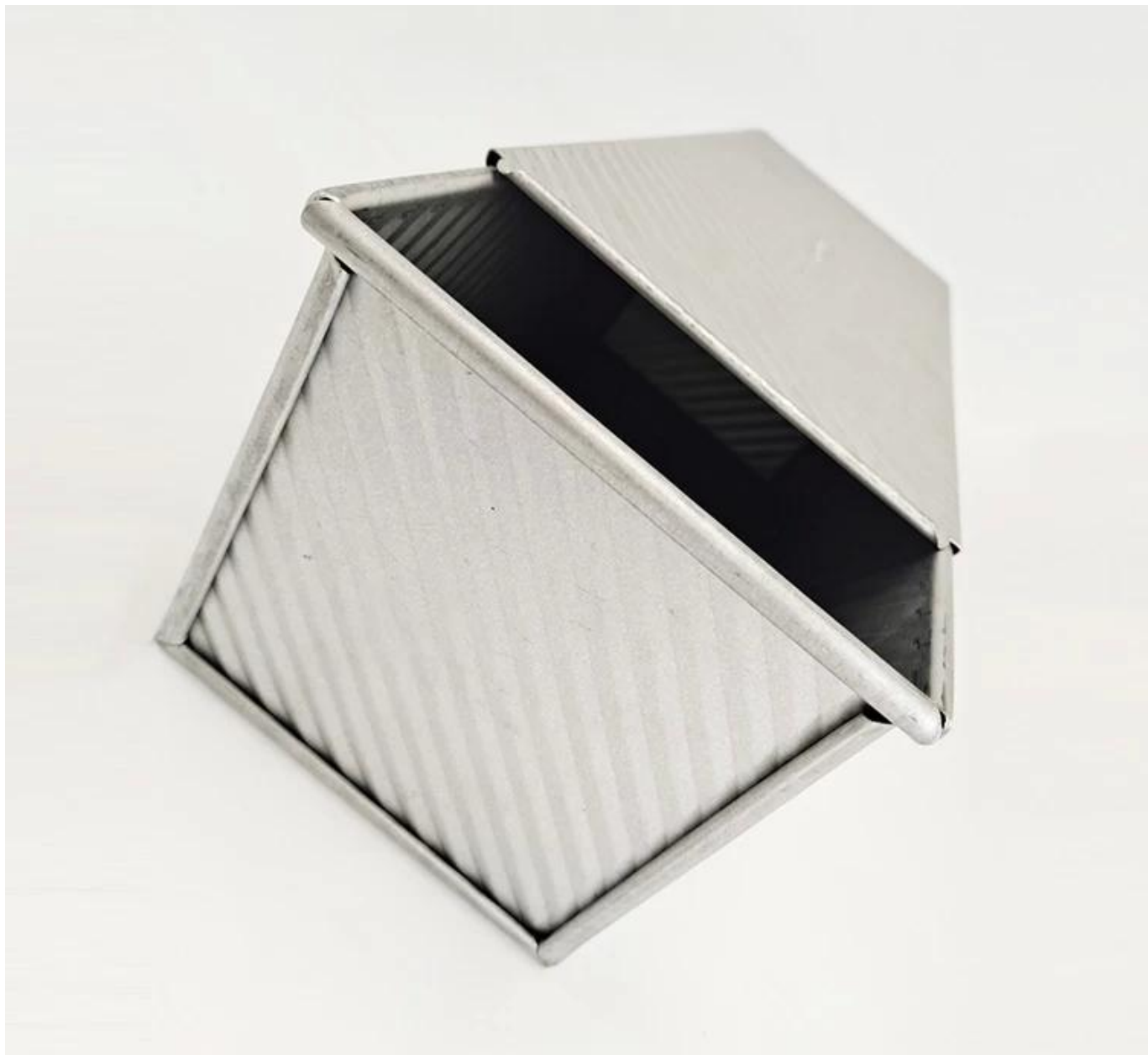



Weitere Arten von Aluminium-Pans & Bread Loaf-Pfannen für Ihre Informationen

Hier sind weitere Typen für Ihre Informationen von Tsingbuy [Aluminium Pans Factory](#).

Unsere Pullman-Loaf-Pans sind mit s gestaltetImple-Stil, schön und praktisch mit. Schnelle Wärmeleitung, auch Heizung, nicht leicht zu erscheinen teilweise versengen.

Material Optional: Aluminium, Aluminisierter Stahl, Edelstahl

Perforationsoptionen: Keine Perforation, Bottom-perforiert, alles perforiert

Szene mit Szene: Single THEAF PAN, GRATE LAAF PAN

Oberflächenoptionen: glatt, gewellt, keine Beschichtung, Teflon Antihaft, Silikon-Non-Stick

Größe: Jede Größe

Deckel: mit Deckel oder nicht als Ihre Anforderung.

customized single loaf pan





Teflon coating

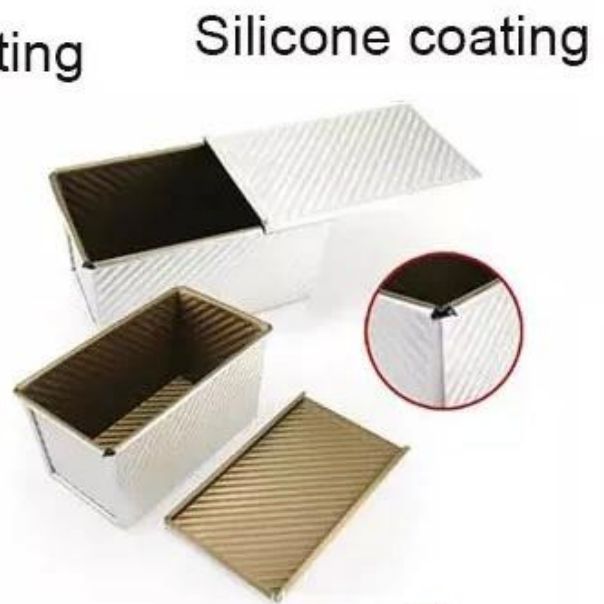

Silicone coating



Material:

Aluminum alloy

Aluminized steel



Benutzerdefiniert Die Herstellung von Strap Laib Pan ist eine unserer größten Stärke, willkommen, um weitere Informationen zu erhalten.

Wir haben seit über 12 Jahren mit der Backware-Fertigung engagiert und beliefert Tausende von Backformen für internationale Kunden. Mit unserem Backen Pfanne Sie können leicht alle möglichen leckeren Lebensmittel machen, Chiffon KuchenS., Mousse-Kuchen, Pfund Kuchen, Käsekuchen usw

More Customized Strap Loaf Pans from Tsingbuy







Customized shape
Customized size
Rack matched

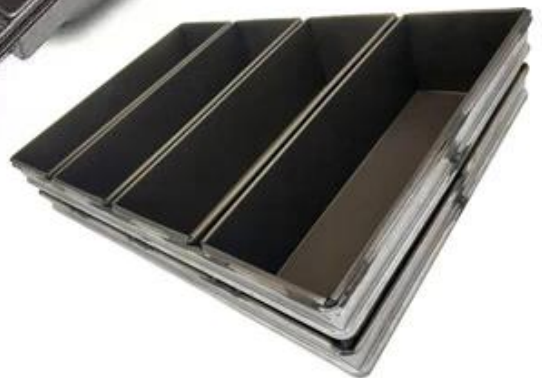

Customized Single Loaf Pan

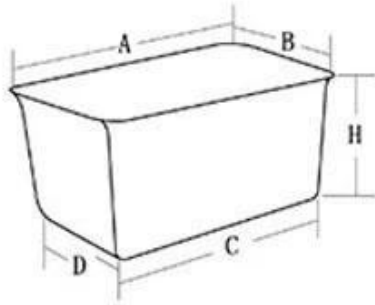

- A. Top length of the item
- B. Top width of the item
- C. Bottom length of the item
- D. Bottom width of the item
- H. Height

Customized Strapped Loaf Pan Sets

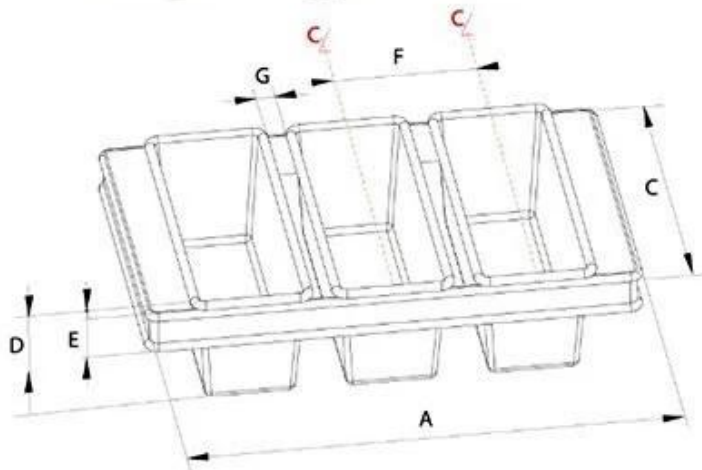

- A. Overall Length
- C. Overall Width
- D. Depth
- E. Frame Height
- F. Center-to-center
- G. Pan Distance



Flat handle



Frame handle



no handle

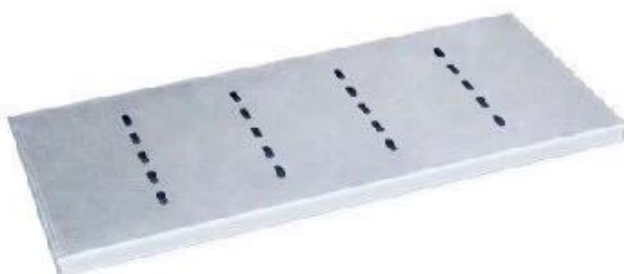

Matching lid (Drop Style)

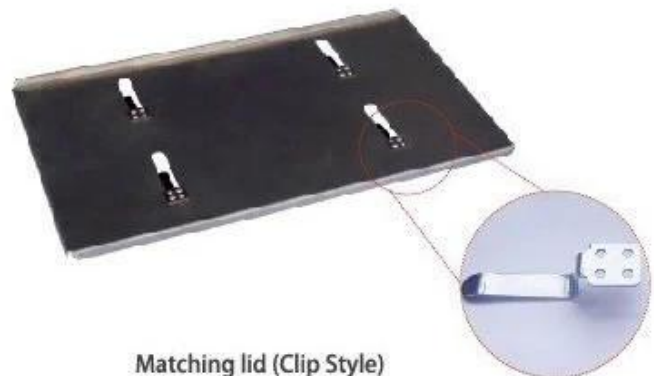

Matching lid (Clip Style)

Fabrikbilder



Loaf Pan

Tsingbuy Industry Limited



Willkommen, um US Tsingbuy Commercial and Industrial zu besuchen [Strap-LAAF-Pfanne mit](#)

Decklieferant.