

Maßgeschneidertes, industrielles Backformen-Set aus aluminisiertem Stahl mit 10 Mulden und antihaftbeschichtetem Riemen für Toast, Sandwich, Brot

Hauptmerkmale des speziell angefertigten Laibbrot-Backformen-Sets mit 10 Mulden aus antihaftbeschichtetem Stahl mit Riemen

1. Diese handelsübliche Brotbackform bietet Platz für (10) Brote mit einer Größe von jeweils 165 x 80 mm. Mit diesem Produkt können Sie zehn Brote herstellen, die Sie schnell verkaufen oder servieren können, und dabei die Backqualität beibehalten. Ganz gleich, ob Sie Ihre typischen Brote oder saisonale Brote zubereiten müssen, diese Brotform ist eine gute Wahl, damit Sie Ihre Backarbeiten problemlos erledigen können.
2. Die Brotkastenformen sind aus 0,7/1,0/1,2 mm starkem Aluminium gefertigtGebogener Stahl mit doppelt gefalteten Ecken, Der Rand von e jede Pfanne ist mit einem Felgendraht mit 5 mm Durchmesser ausgestattet. Die Rahmen hergestellt werden von 1,2 mm Aluminiumeder Stahl für super Halt und Haltbarkeit. Die Oberfläche von Brotbackformen Sind geriffeltes Finish und mit Dampföchern. Nicht für glutenfreie Mischungen geeignet.
3. Dieses Riemenbrot Die Kastenform wird in hergestellt China [Hersteller großer Kastenformen](#) - Tsingbuy Industry Limited. Es ist in verschiedenen Größen erhältlich, in Verschiedene Konfigurationen für alle Industrie-, Gewerbe- und Haushaltsöfen.

Produktbilder von Maßgeschneidertes Laibbrot-Backformenset aus aluminisiertem Stahl mit 10 Mulden und antihaftbeschichtetem Riemen







3 pcs



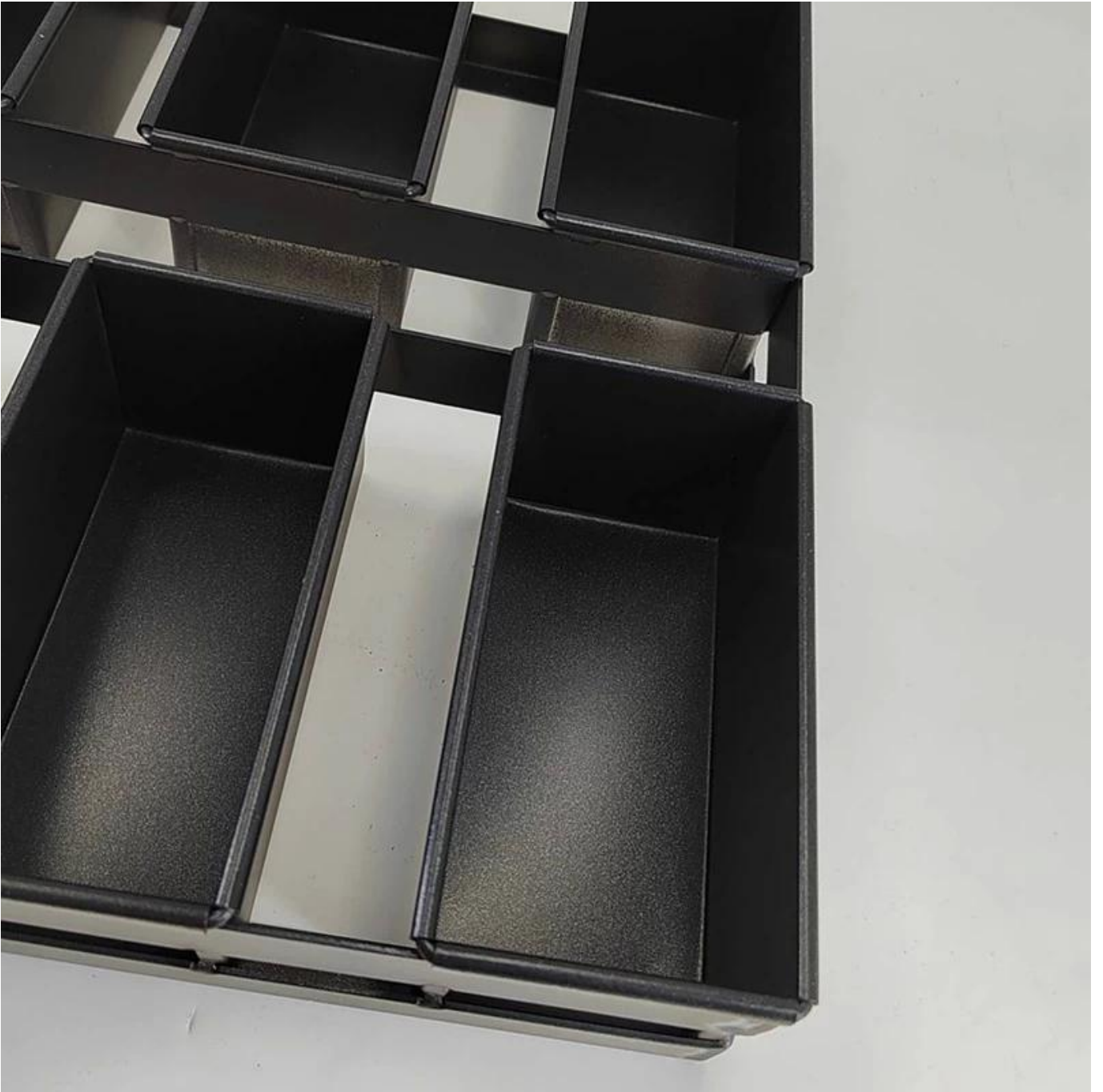



Tsingbuy ist Fachmann in Herstellung beide einzel Brot Pfanne Und Gurt Brot Pfannen. Hier Wir Aktie Einige Modelle von Laibpfannen mit Riemen als Referenz. Die meisten Laibbackformen mit Riemen werden je nach Bedarf individuell angefertigt.

More Customized Strap Loaf Pans from Tsingbuy



Customized Single Loaf Pan

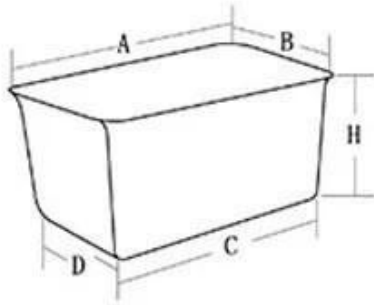

- A.Top length of the item
- B.Top width of the item
- C.Bottom length of the item
- D.Bottom width of the item
- H.Height

Customized Strapped Loaf Pan Sets

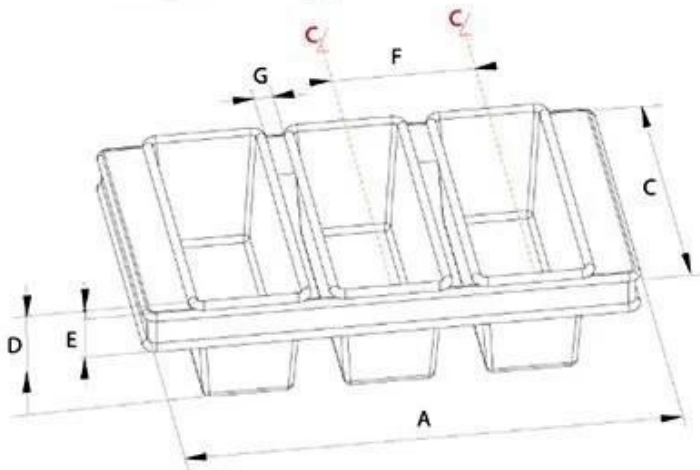

- A.Overall Length
- C.Overall Width
- D.Depth
- E.Frame Height
- F.Center-to-center
- G.Pan Distance



Flat handle



Frame handle



no handle

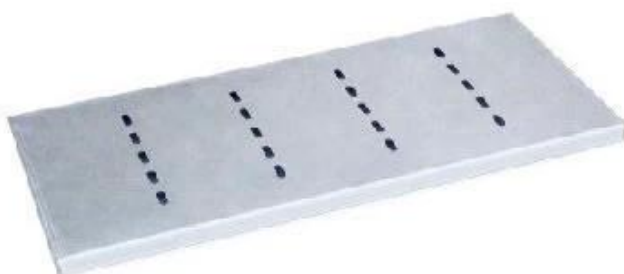

Matching lid (Drop Style)

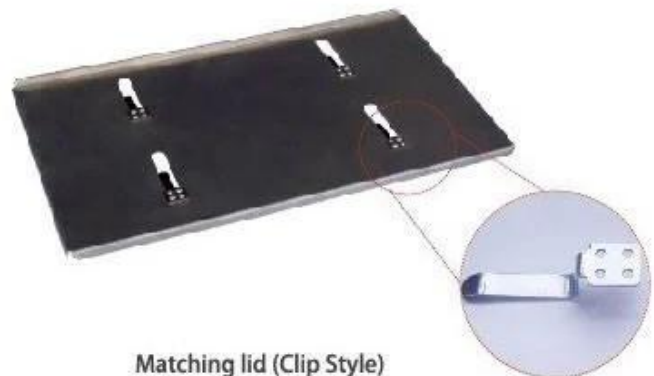

Matching lid (Clip Style)

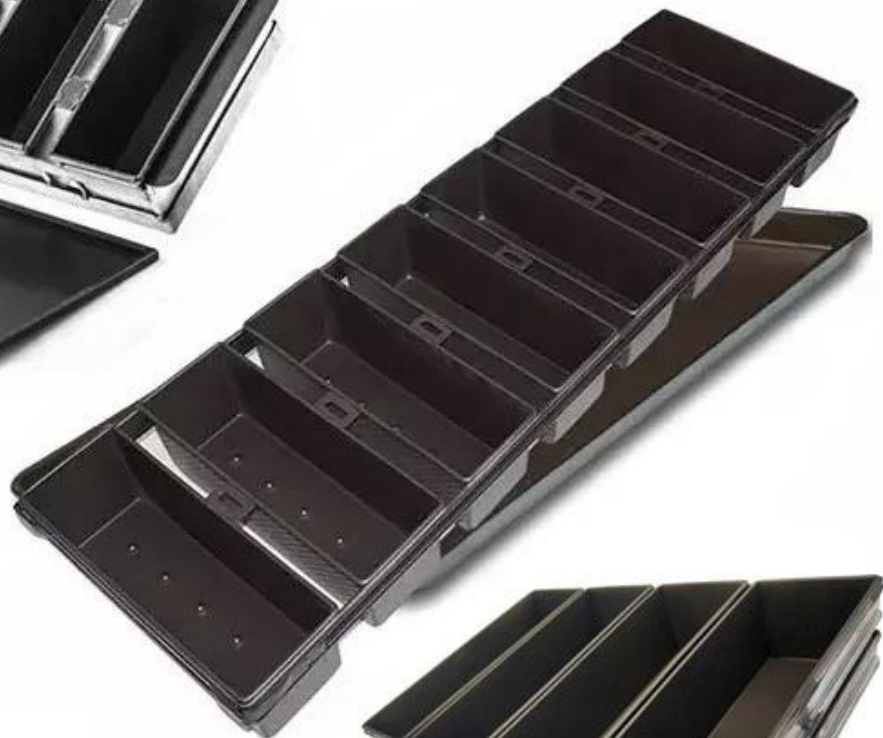

Customized shape
Customized size
Rack matched

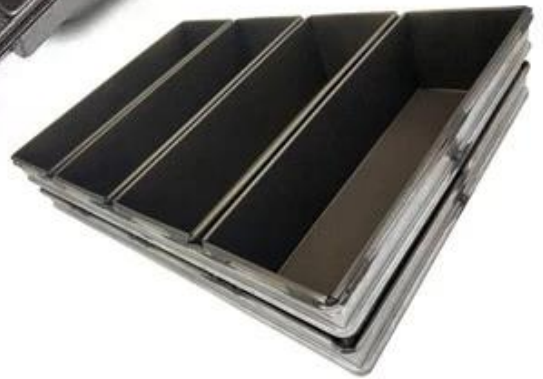

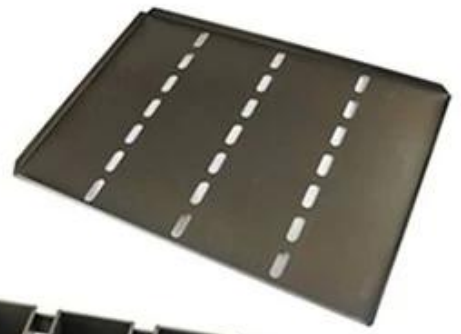

Procedures for custom made loaf baking pans

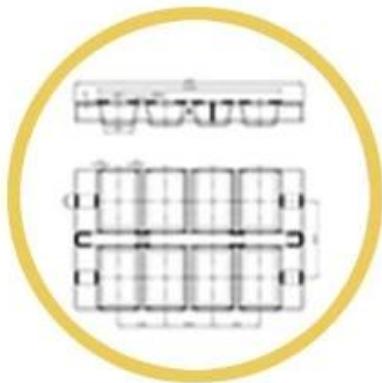

1. DRAWING



2. DESIGN



3. PRODUCT



6. SHIPPING



5. LOADING



4. PACKING



Custom Made
Strap Loaf Pan
Used with
Bakery Trolley



Weitere Arten von Einzelbrotbackformen für die heimische Küche, Bäckerei, Restaurant usw

Hier sind einige „klassische“ Modelle von Einzelbrotbackformen von Tsingbuy [Lieferant von antihftbeschichteten Kastenformen.](#)

Single Loaf Pan



natural surface



corrugated



full perforation



nonstick



corrugated



golden color



holes at bottom



full perforation



custom size







Außerdem **[Brotkastenform im Großhandel](#)** Der Hersteller von Tsingbuy-Backformen bietet auch kundenspezifisches Design und den Großhandel mit anderen kommerziellen Backformen an, wie z. B. Blechpfannen, Baguettepfannen, Kastenformen, Backformen mit mehreren Formen, Backwagen, Kuchenformen usw. Gerne können Sie sich beraten lassen uns jederzeit.

