

Maßgeschneiderte große Hohlräume, antihftbeschichtete Kastenform, Toastbrotform, Sandwich-Backform, kommerzielles Backformen-Set

Hauptmerkmale des großformatigen Laibpfannen-Toastbrot-Backformen-Sets mit Riemen

1. Hochwertige Konstruktion: Unsere Kastenform besteht aus langlebigem aluminiertem Stahl mit einer erstklassigen Antihft-Oberfläche. Es ist für den Einsatz in stark frequentierten Großküchen ausgelegt und leicht zu reinigen.
2. Effizientes Design: Mit drei Mulden und geschickt platzierten Löchern am Boden sorgt diese Pfanne für ein gleichmäßiges Backen und hilft Ihnen, mehr Brote auf einmal zu backen, was Ihre Produktivität steigert.
3. Individuelle Optionen: Wir bieten verschiedene Laibpfannen mit Riemen an, die Ihren Anforderungen entsprechen. Ganz gleich, ob Sie mehr Hohlräume, andere Formen oder individuelle Größen benötigen, wir können Ihren Anforderungen gerecht werden.
4. Maschinenfreundlich: Unsere Pfanne passt nahtlos in Maschinenproduktionslinien und eignet sich daher perfekt für groß angelegte Backvorgänge in Bäckereien, Lebensmittelabriken usw.
5. Erschwingliche Qualität: Tsingbuy [Hersteller von Laibpfannen mit Riemen](#) verfügt über mehr als 15 Jahre Erfahrung mit gewerblichem Backgeschirr und bietet Produkte von höchster Qualität zu wettbewerbsfähigen Preisen. Schließen Sie sich unseren zufriedenen Kunden an und verbessern Sie noch heute Ihr Backspiel!

Produktbilder des antihftbeschichteten Kastenform-Sets mit großen Hohlräumen und Riemen für Toastbrot













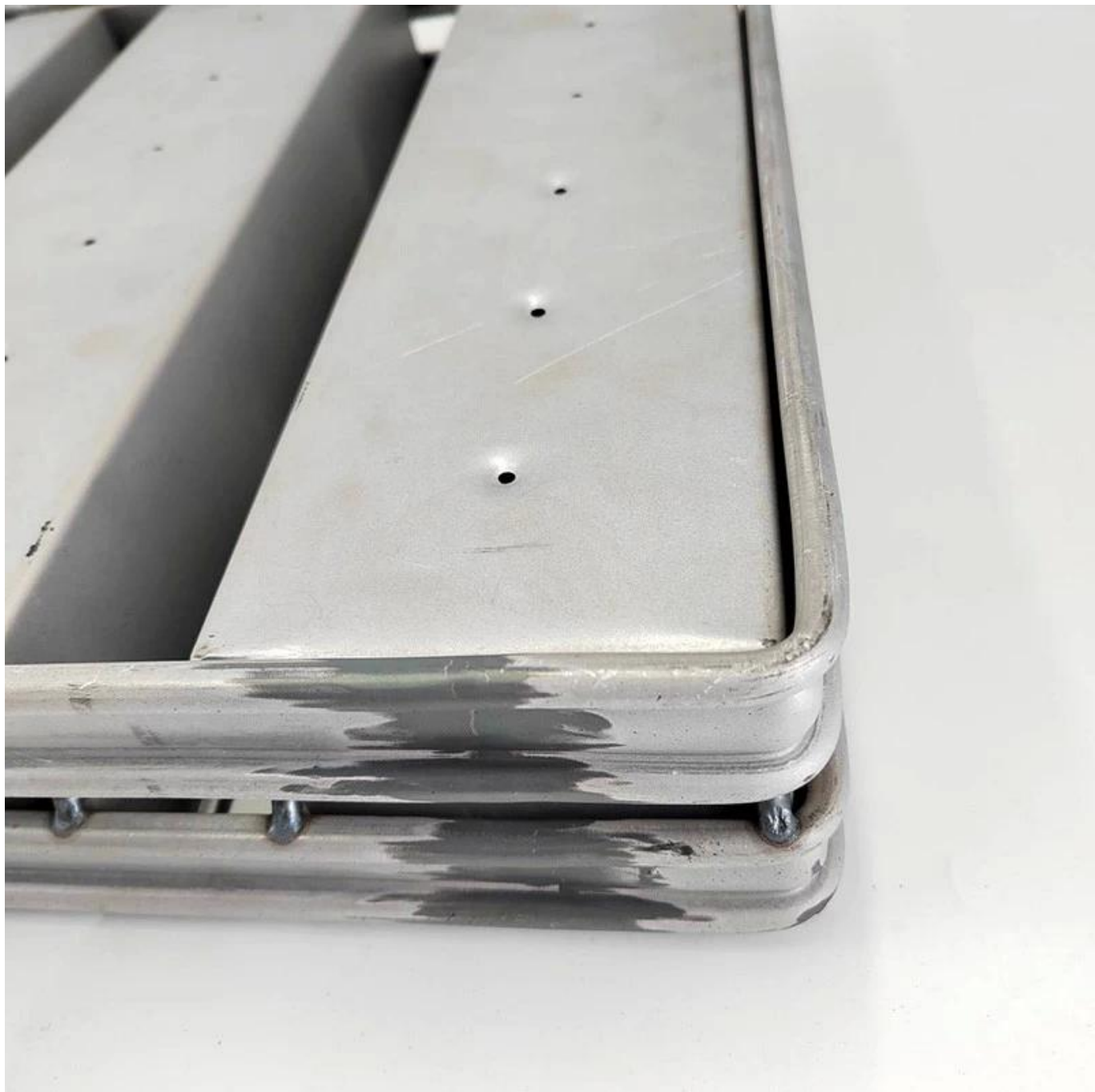

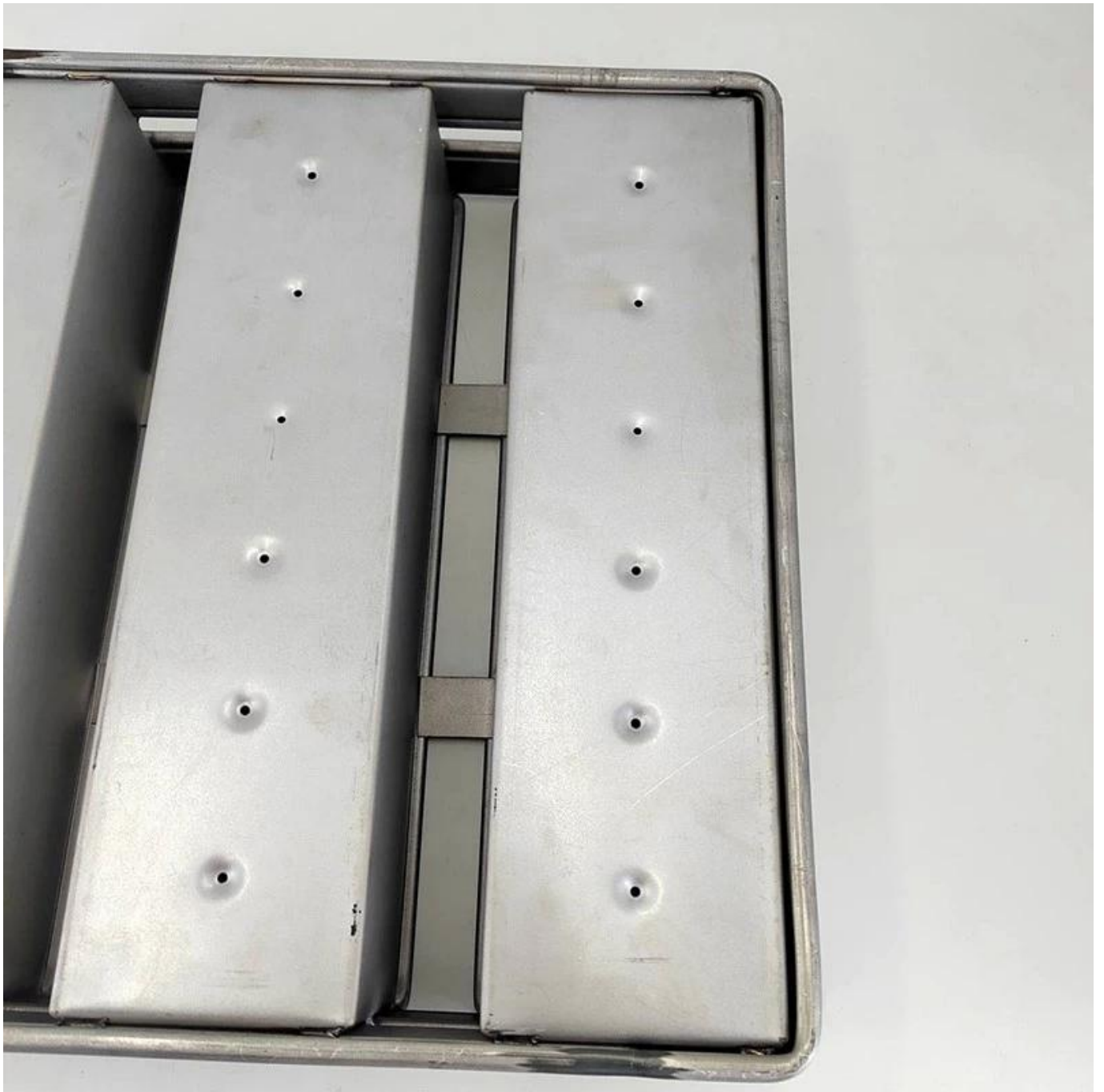

Tsingbuy ist professionell in der Herstellung von Einzelbrotpfannen und Gurtbrotpfannen. Hier teilen wir Ihnen einige Modelle von Laibpfannen mit Riemen als Referenz. Die meisten Laibbackformen mit Riemen werden je nach Bedarf individuell angefertigt.

More Customized Strap Loaf Pans from Tsingbuy



Customized Single Loaf Pan

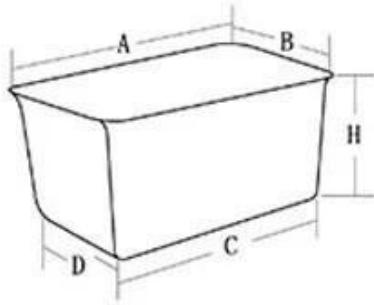

- A. Top length of the item
- B. Top width of the item
- C. Bottom length of the item
- D. Bottom width of the item
- H. Height

Customized Strapped Loaf Pan Sets

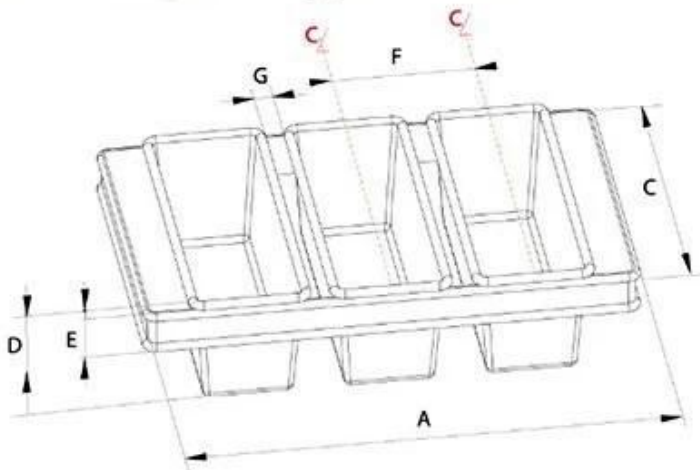

- A. Overall Length
- C. Overall Width
- D. Depth
- E. Frame Height
- F. Center-to-center
- G. Pan Distance



Flat handle



Frame handle



no handle



Matching lid (Drop Style)

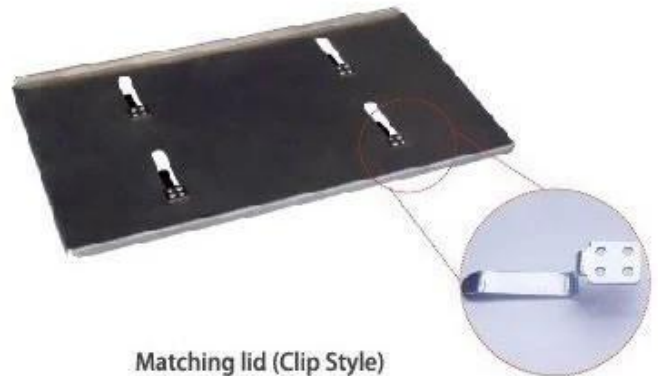

Matching lid (Clip Style)



Customized shape
Customized size
Rack matched

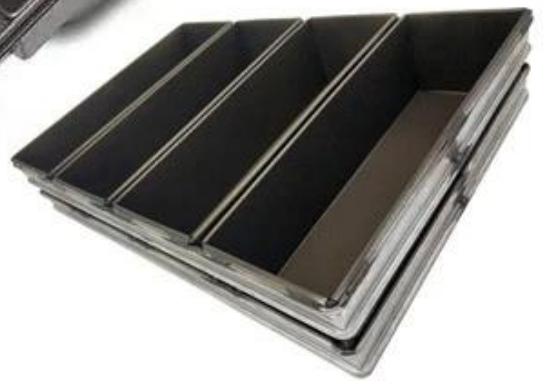

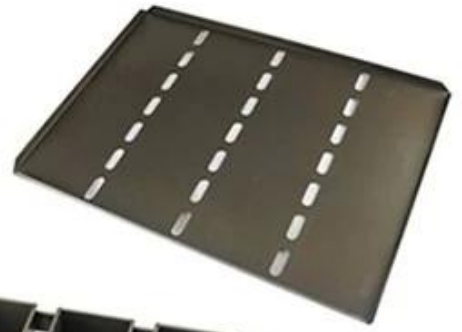

Procedures for custom made loaf baking pans

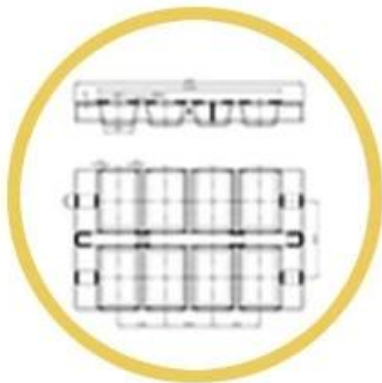

1. DRAWING



2. DESIGN



3. PRODUCT



6. SHIPPING



5. LOADING



4. PACKING



Custom Made
Strap Loaf Pan
Used with
Bakery Trolley

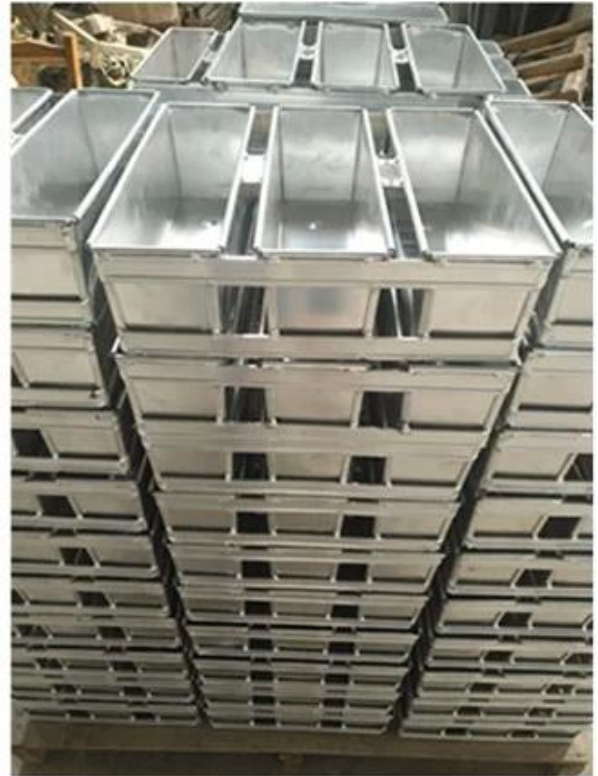

Weitere Arten von Einzelbrotbackformen für die heimische Küche, Bäckerei, Restaurant usw

Hier sind einige „klassische“ Modelle von Einzelbrotbackformen von Tsingbuy [Lieferant von antihftbeschichteten Kastenformen.](#)

Single Loaf Pan



natural surface



corrugated



full perforation



nonstick



corrugated



golden color



holes at bottom



full perforation



custom size







Außerdem **[Brotkastenform im Großhandel](#)** Der Hersteller von Tsingbuy-Backformen bietet auch kundenspezifisches Design und den Großhandel mit anderen kommerziellen Backformen an, wie z. B. Blechpfannen, Baguettepfannen, Kastenformen, Backformen mit mehreren Formen, Backwagen, Kuchenformen usw. Gerne können Sie sich beraten lassen uns jederzeit.

