

Perforated Anodized Aluminum Baking Sheet Pans, French Italian Russian Napoleon Cake Mille Feuille Puff Pastry Baking Tray, Crispy Baking Tray

Product description of Napoleon Dessert Millefeuille Puff Pastry Baking Tray

Introducing our Napoleon dessert Millefeuille puff pastry baking tray, the ultimate companion for pastry enthusiasts and professional bakers alike. Crafted with precision and durability in mind, this baking tray is designed to elevate your baking experience to new heights.

Constructed from high-quality 1.5mm thick aluminum, this baking tray is durable and can withstand the rigors of frequent baking sessions. It also boasts exceptional heat conductivity, ensuring even baking every time. Its anodized surface provides a non-stick coating, making for effortless release and hassle-free cleaning.

With four sizes to choose from, you have the flexibility to create pastries of various dimensions, catering to your specific needs and preferences. Whether you're baking for a small gathering or a large event, this tray has you covered.

One of the standout features of our baking tray is its innovative design, featuring two perforated sheets that slide on and off effortlessly. This unique design not only facilitates airflow, promoting even heat distribution and uniform baking, but also prevents over-expansion of puff pastry, ensuring that your pastries maintain their shape and structure perfectly to create professional-looking millefeuille and other layered pastries.

Versatility is key with our Napoleon dessert Millefeuille puff pastry baking tray. While it's ideal for crafting exquisite French Napoleon desserts, it's also perfect for creating a myriad of other delicacies, including millefeuille, puff pastry, and crispy treats. It can be also used as a cookie baking sheet, making it a practical addition to your kitchen bakeware collection. Let your creativity run wild as you explore the endless possibilities this versatile tray has to offer.

Whether you're a seasoned pastry chef or an amateur baker, this Napoleon dessert Millefeuille puff pastry baking tray from Tsingbuy [perforated tray manufacturer in China](#) is sure to elevate your baking game and delight your taste buds with perfect pastries every time.

Product Images of Napoleon Dessert Millefeuille Puff Pastry Baking Tray



Multiple Functions

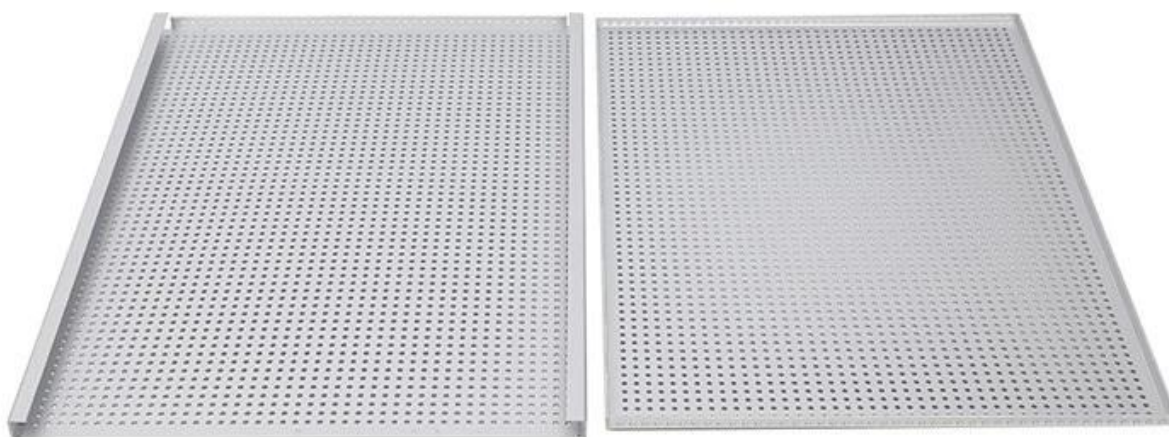

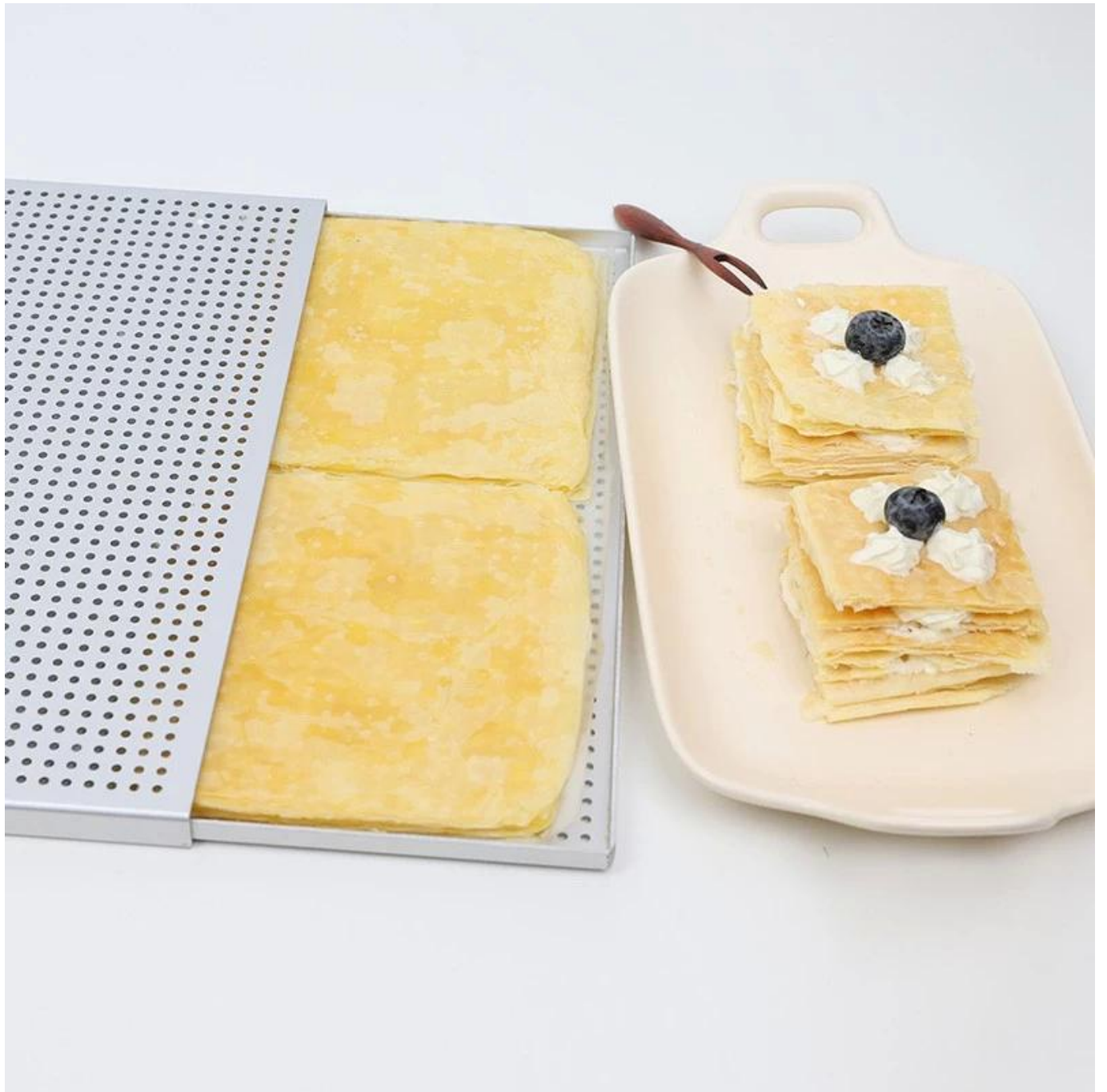





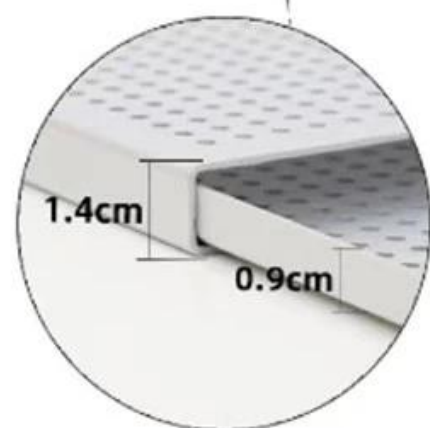

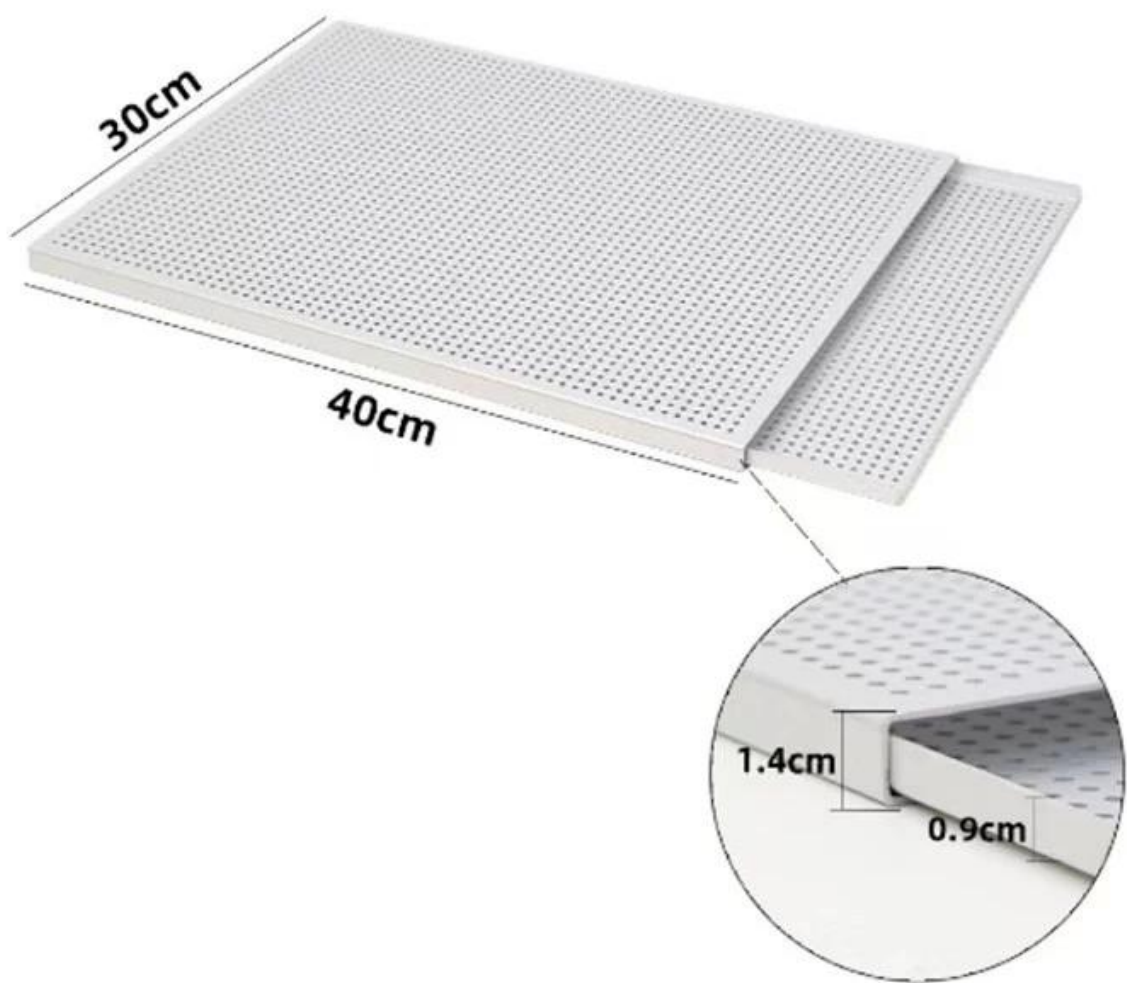

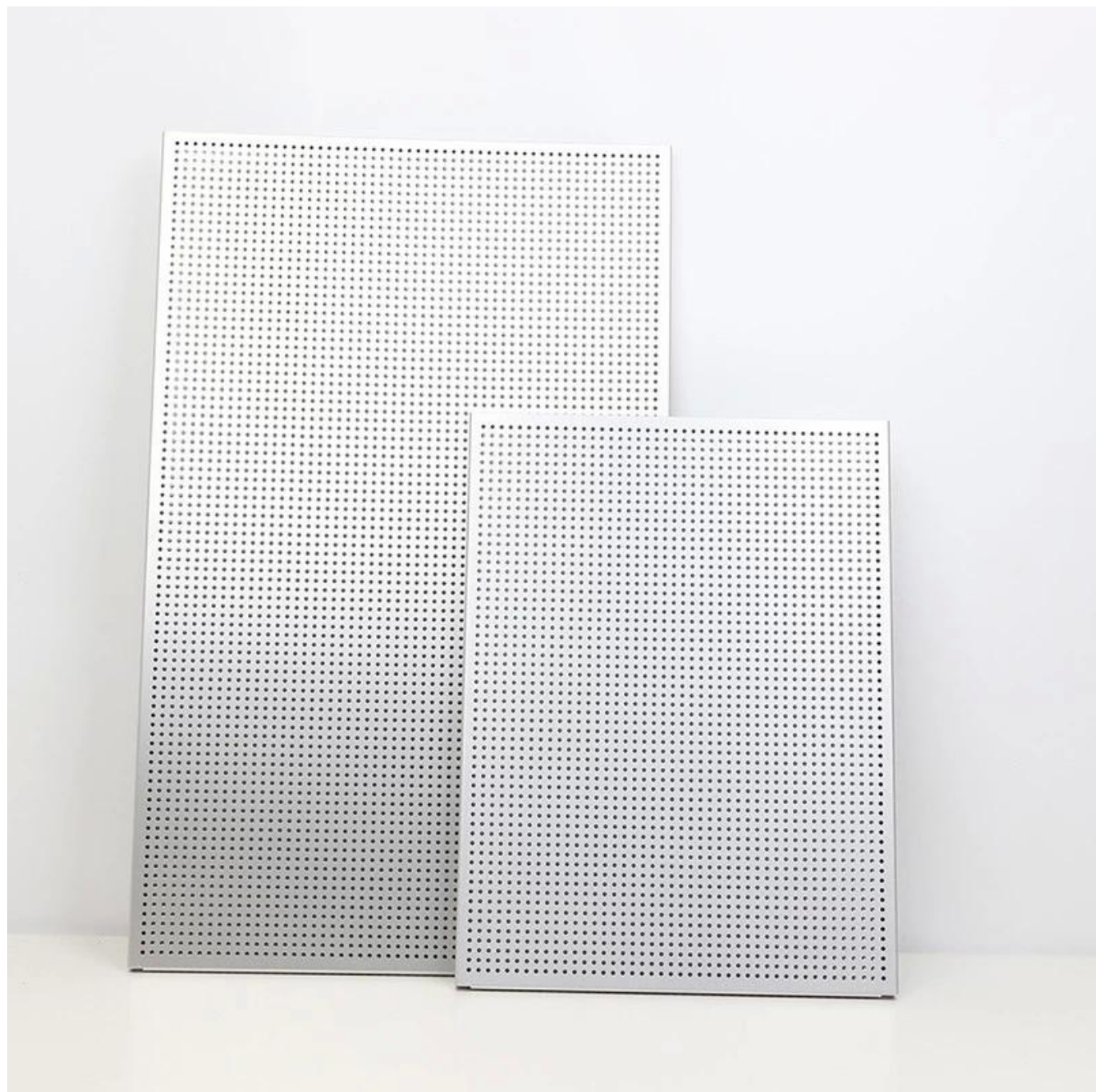

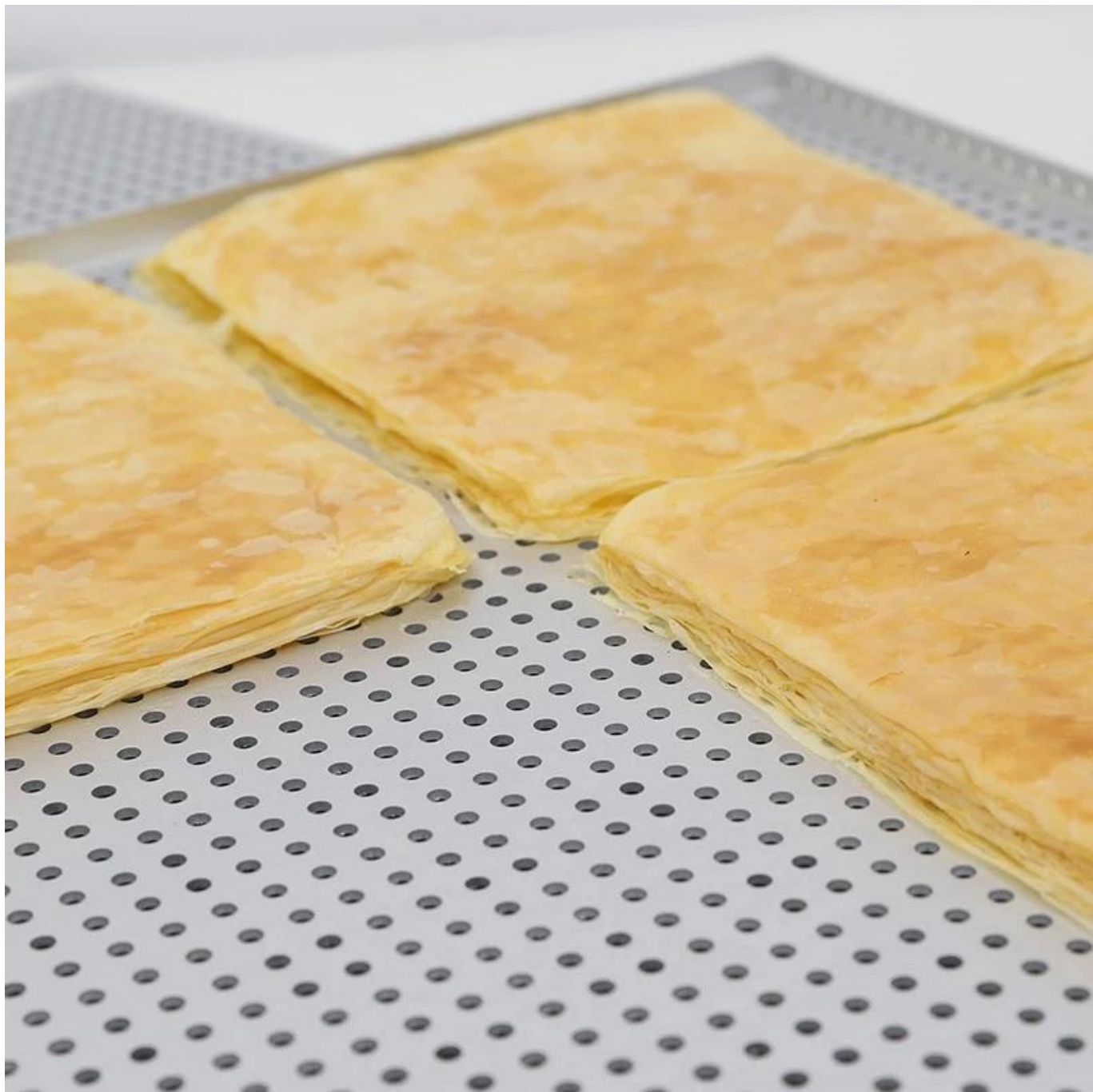

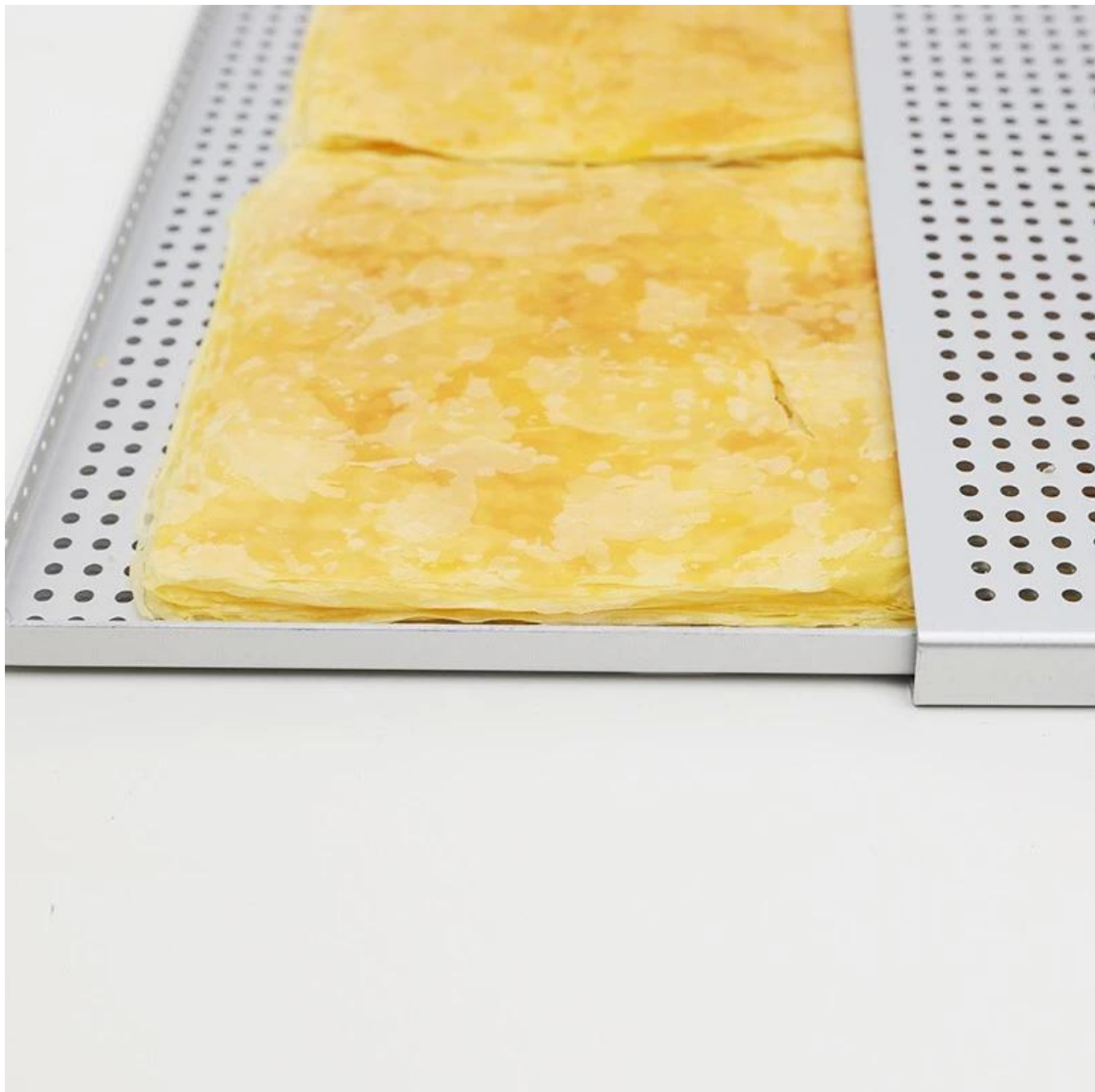

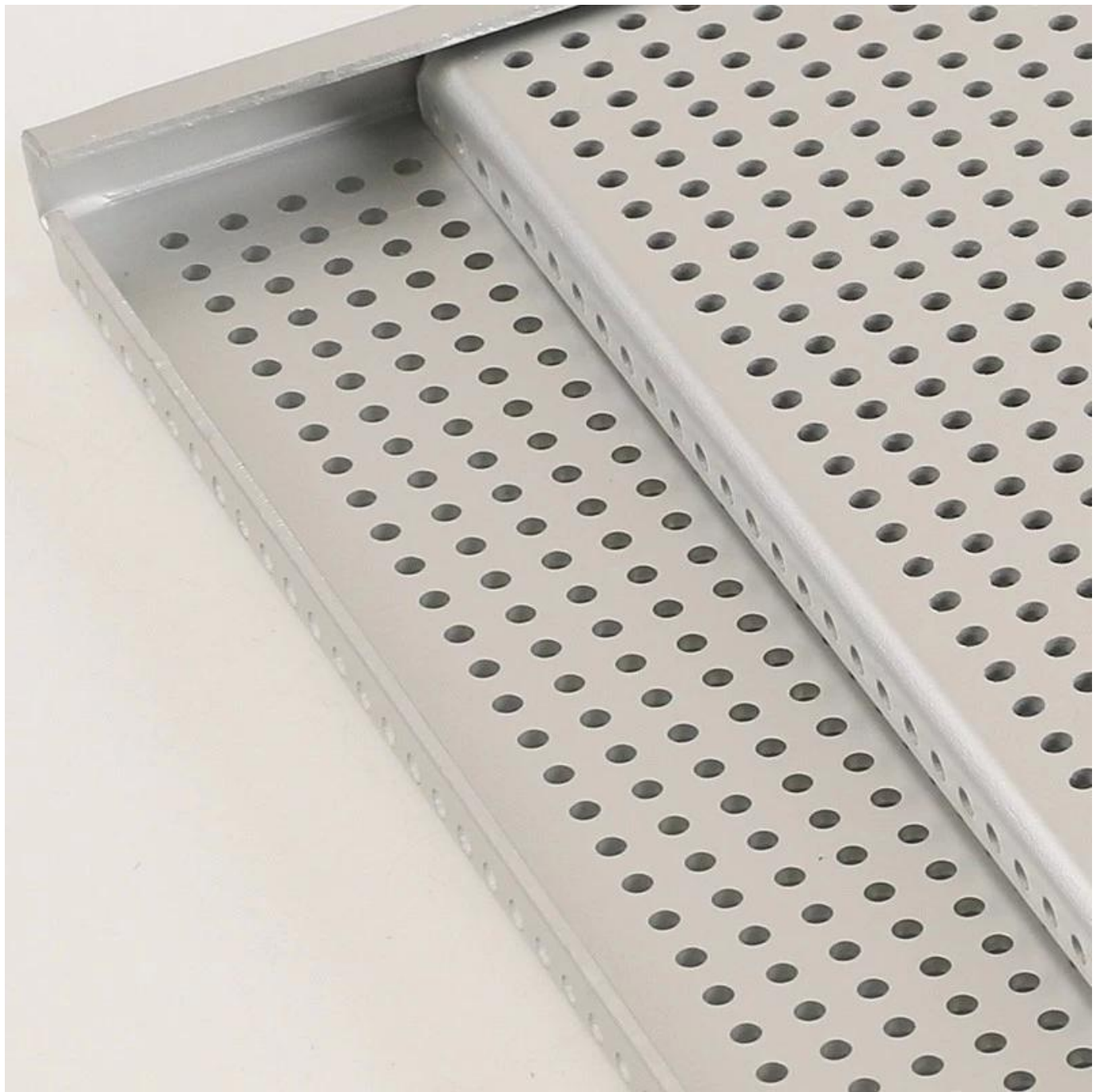





Tsingbuy Commercial Baking Tray Factory

Tsingbuy [China aluminum baking pans manufacturer](#) produces both household and commercial sheet pans for wholesale and export with much experience. It helps even heating from corner to corner and bake batches in less time. This smaller baking sheet is perfect for appetizers and fit for most toaster ovens. The dimensions of oven tray is 17x13 inches.

You can customized sheet pans with many options in material, size, type, surface finish and so on. Tell us your required specifications and we can produce sheet pan meeting your needs.

More sheet pans from Tsingbuy for your reference as following.

Integrated Machine Stamped Sheet Pans



wire in rim



corrugated



perforated



nonstick



perforated



with bars

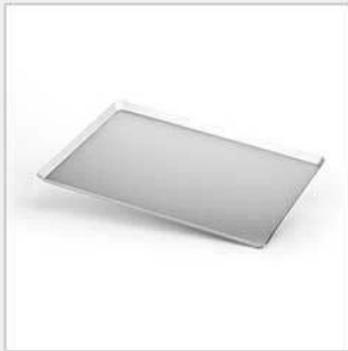

no wire rim



nonstick

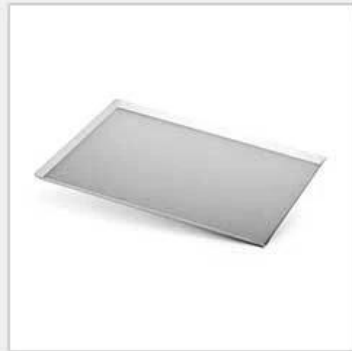

right angle



nonstick



gold color



stainless steel

Handmade Sheet Pans



400*720mm



U-shaped



Square



nonstick



600*800mm



inclined edge

More Custom Baking Trays

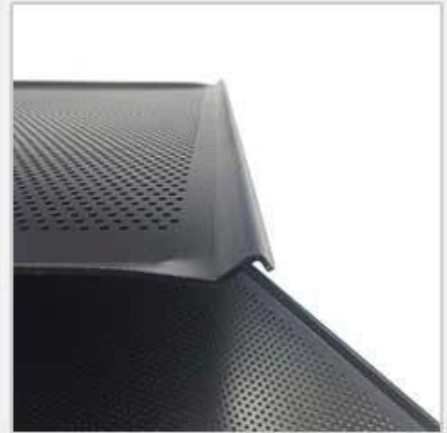

sheet pan with lid

flat baking sheet

perforated tray with lid





Our Sheet Pan Workshop ODM & OEM Service

Well equipped with CNC machines, punching, cutting, moulding machines, our annual production ability has been over 150million US-dollars



Besides [wholesale Aluminum baking sheet in China](#), Tsingbuy provides custom design and manufacturing of more bakery bakeware for commercial use, such as French bread baguette pan, strap loaf pan, multi-mould cupcake baking pan, bakery trolley etc. Welcome to contact us at any time if you are in the market for baking pans.

MAIN PRODUCT

● Industry cup tray



● Baguette tray



● Sheet pan



● Bakery Trolley



● Bread pan set



